

Mengen "Löchleacker" Gesamtplan

Der Klick auf einen eisenzeitlichen Befund führt direkt zu der dazu gehörigen Profilzeichnung.

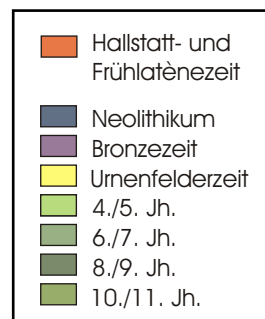

Mengen "Löchleacker"

Zeichnungen der eisenzeitlichen Befunde

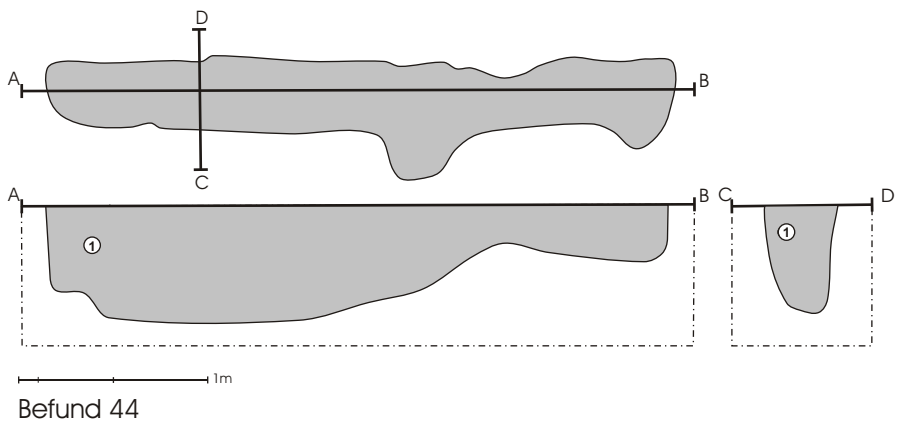
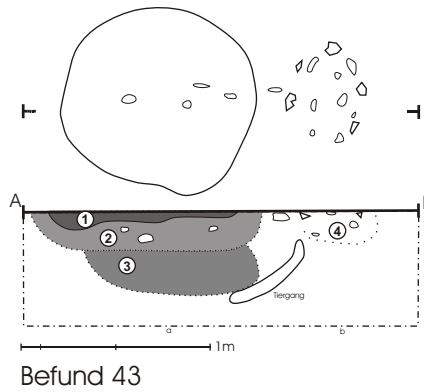
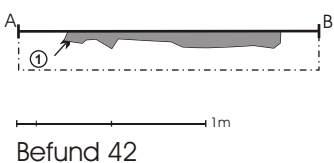
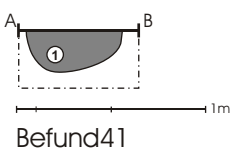
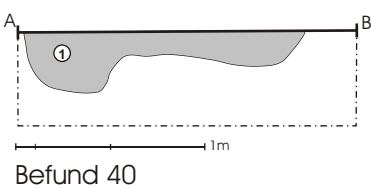
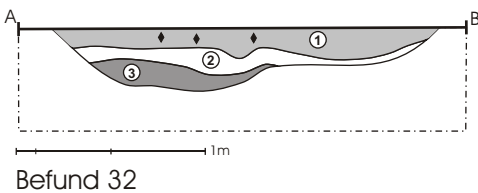
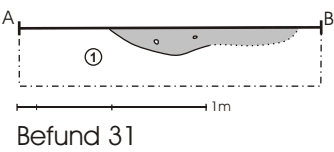
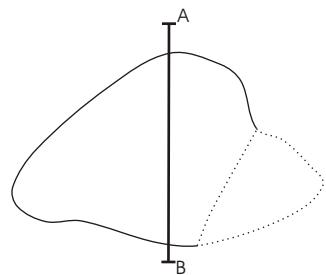
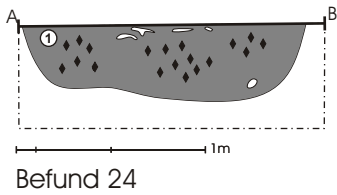

- Holzkohle
- Gebrannter Lehm
- Stein
- Lehm
- Grau/dunkelgelb
- Hellbraun
- Mittelbraun/stark gefl. Löß
- Dunkelbraun
- Graubraun
- Schwarzbraun/schwarzgrau
- Brandschicht

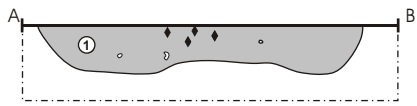

Befund 51



Befund 84

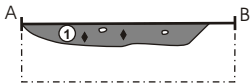

Befund 57



Befund 88

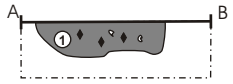

Befund 60

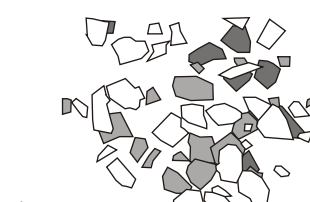

Befund 77

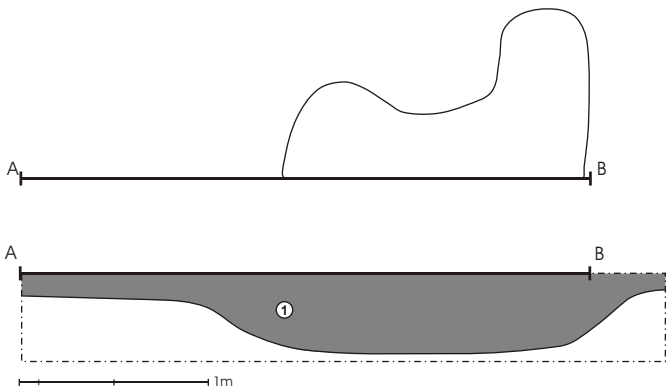

Befund 70

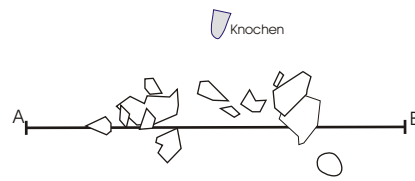

Befund 83

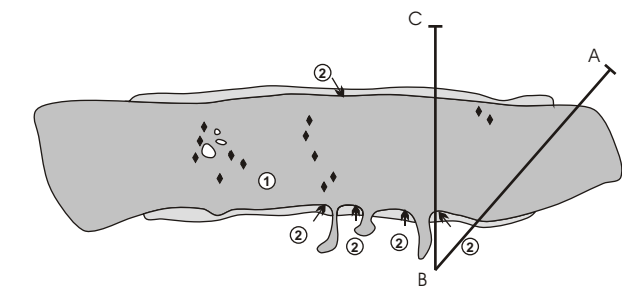

Befund 71

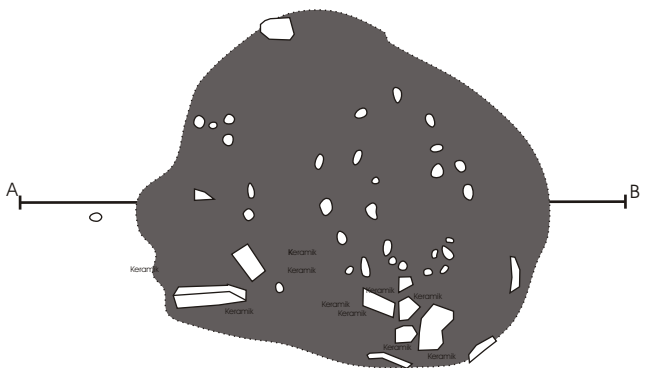

Befund 85

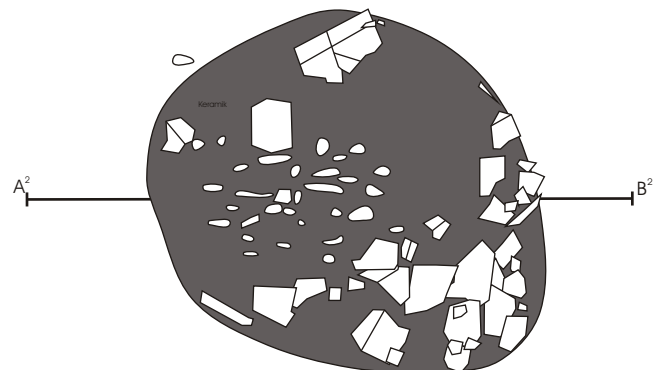
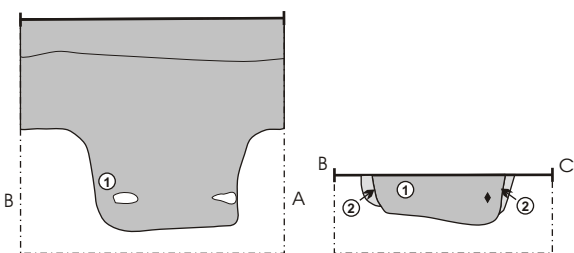

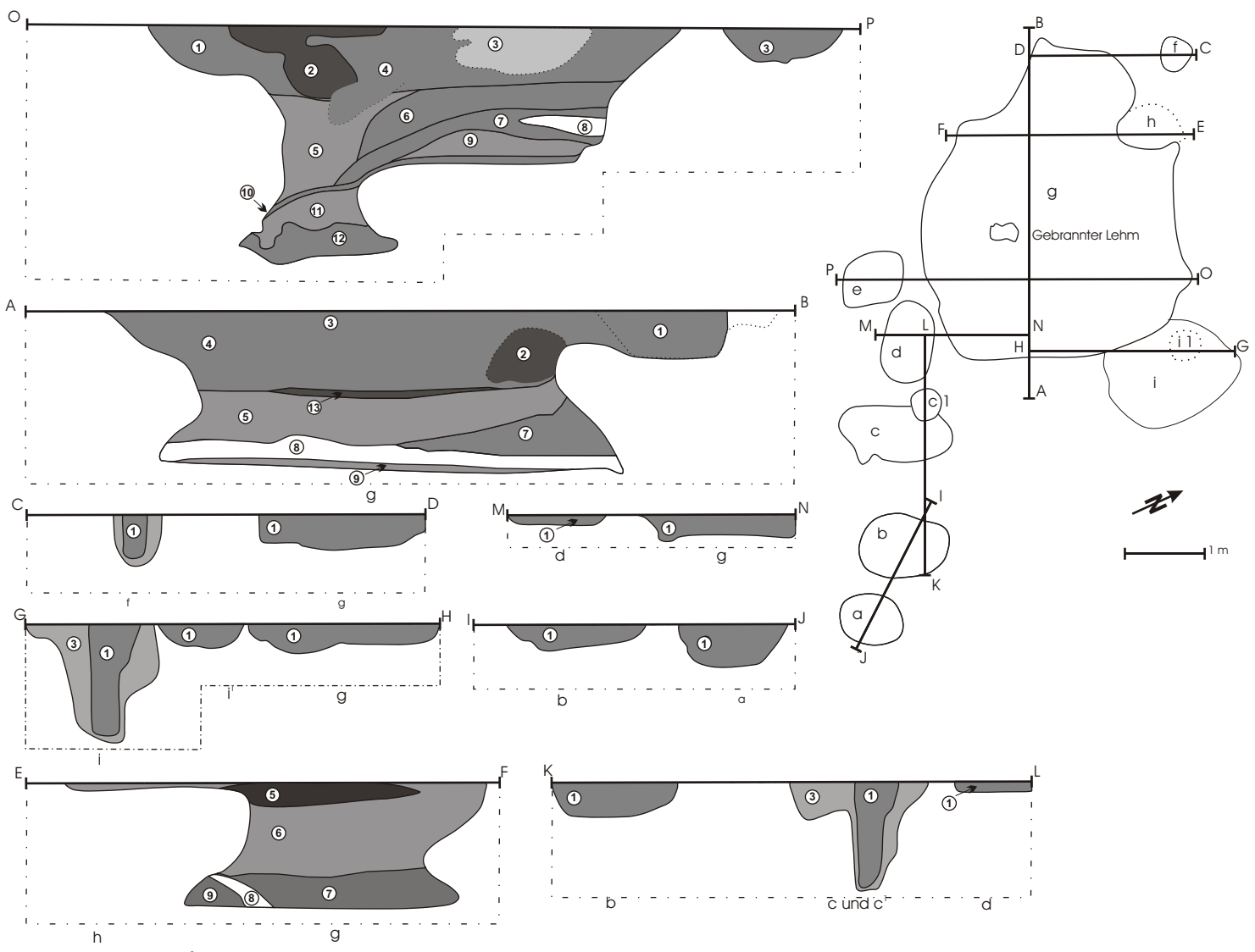

Befund 86

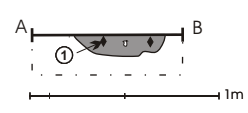

Befund 89

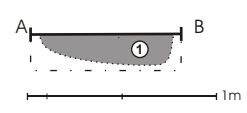

Befund 97

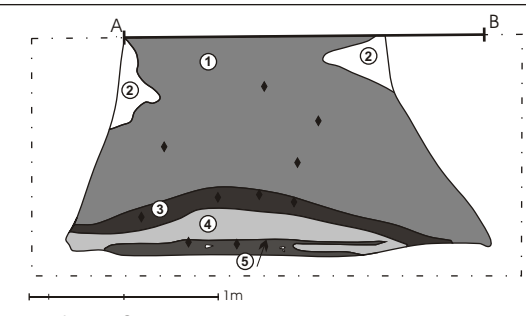

Befund 91

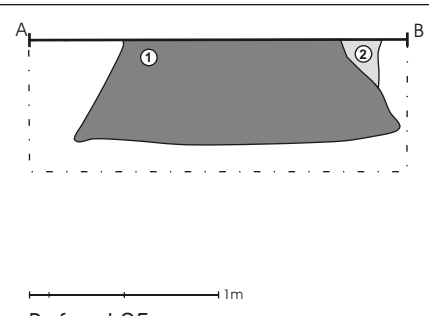

Befund 95

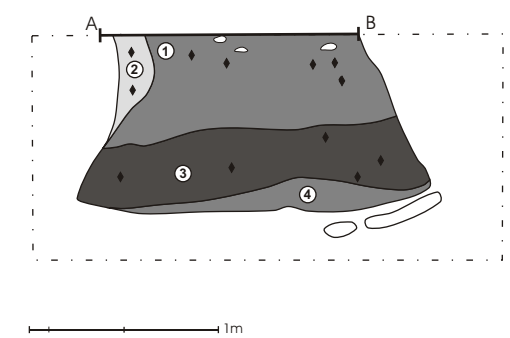

Befund 92

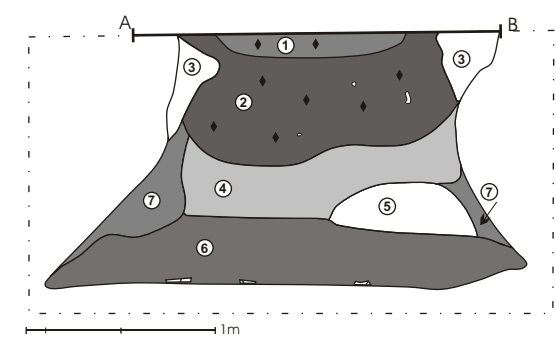

Befund 98

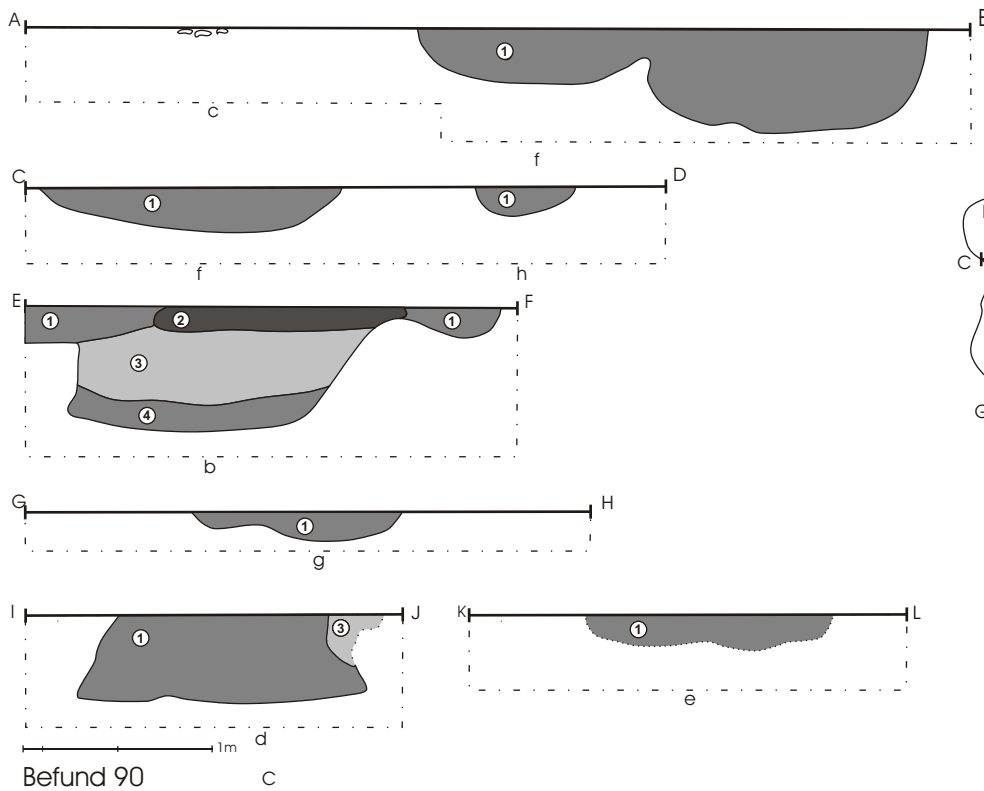

Befund 90

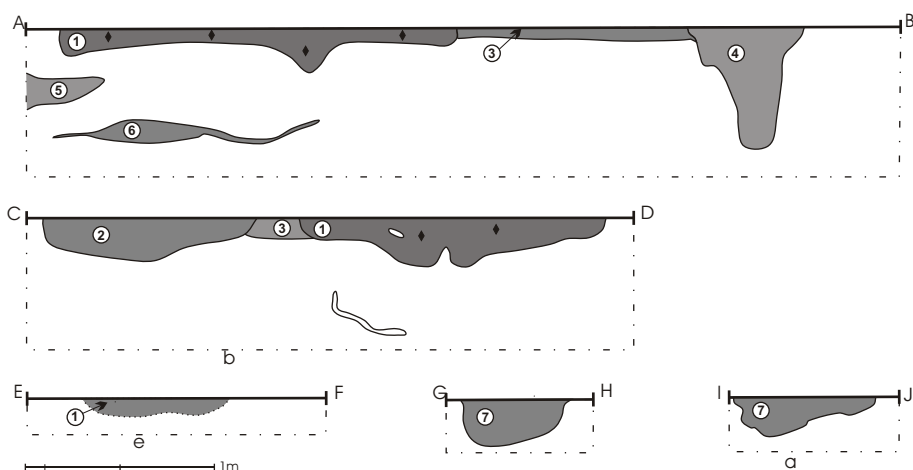
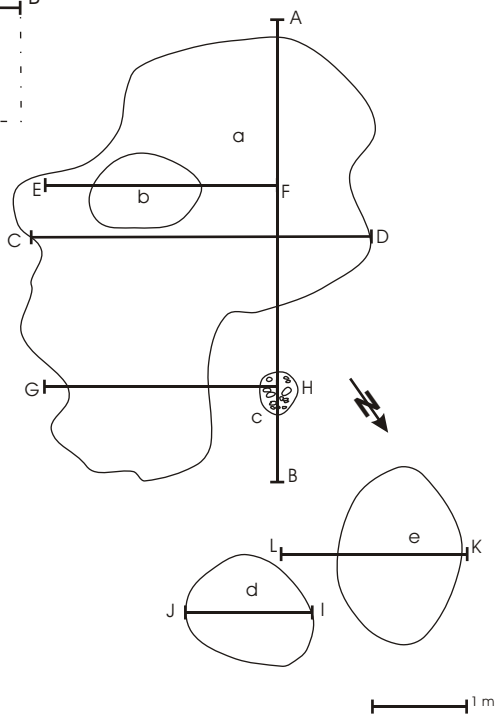

Befund 96

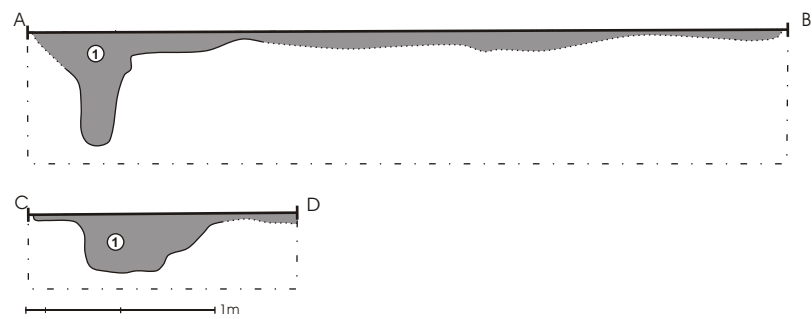
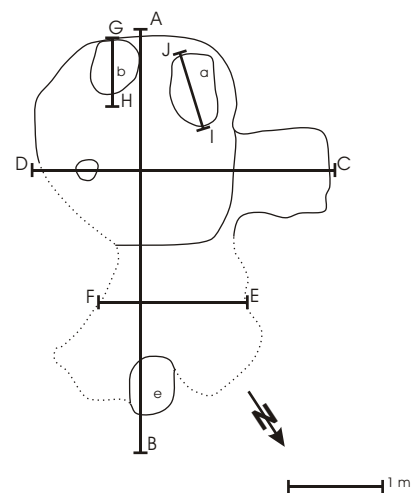

Befund 101

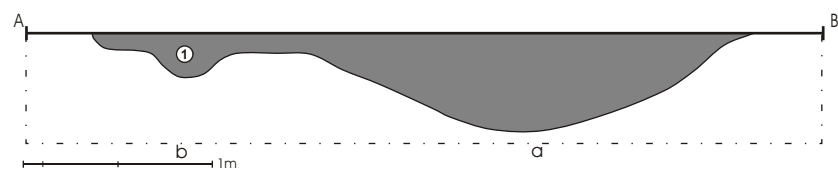
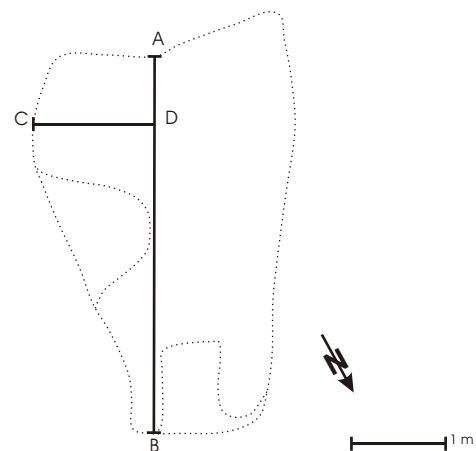

Befund 105

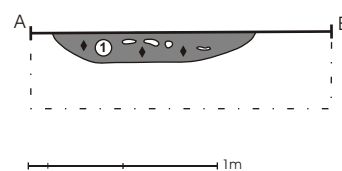

Befund 103

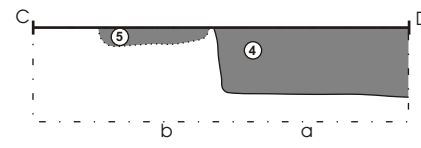
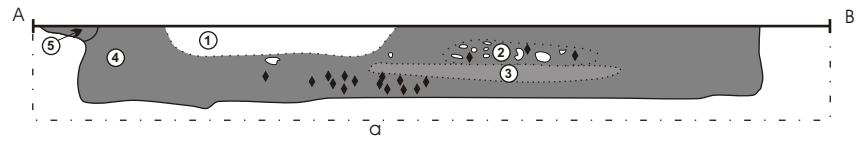
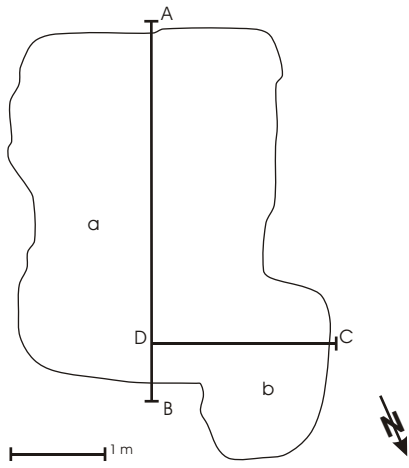

Befund 107

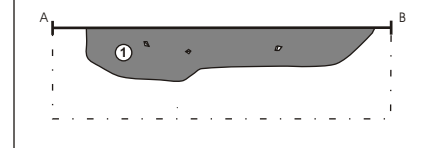

Befund 108

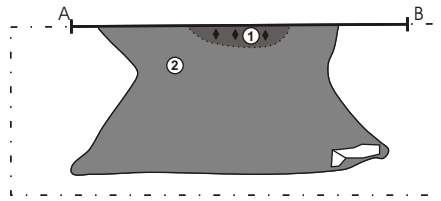

Befund 109

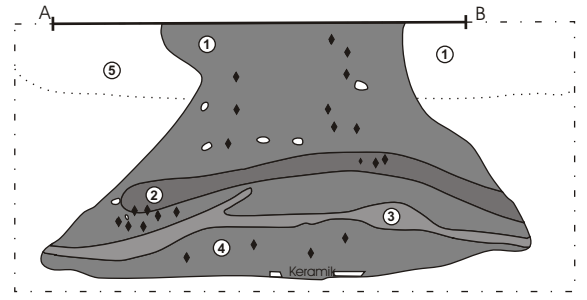

Befund 110

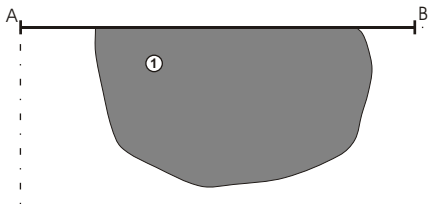

Befund 111

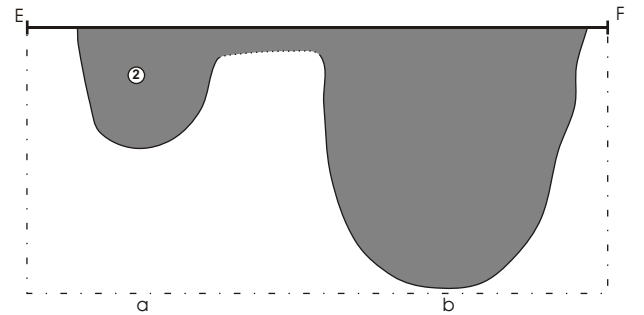
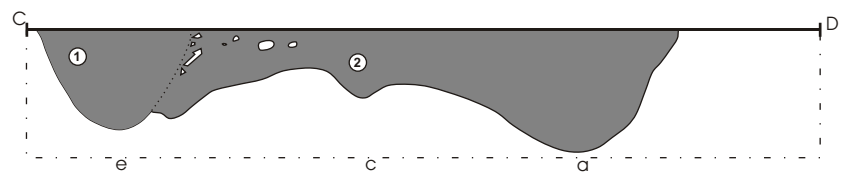

Befund 112

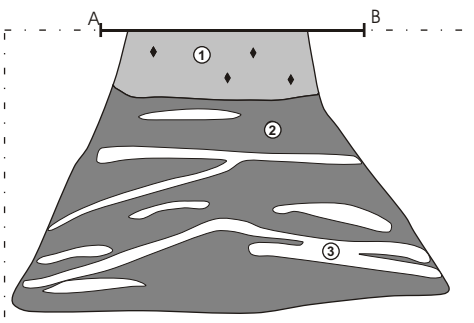
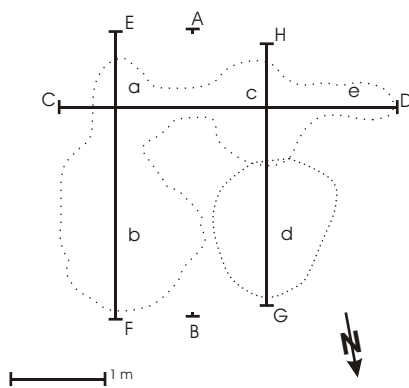

Befund 115

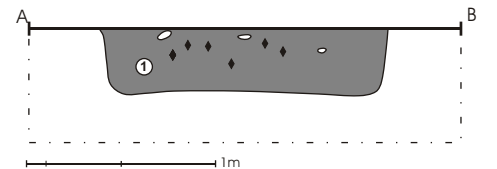

Befund 117

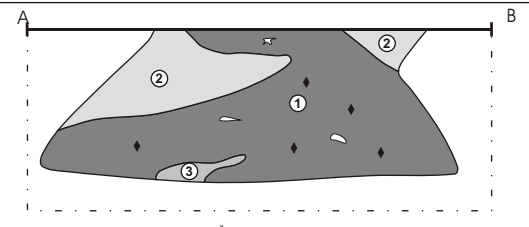

Befund 118

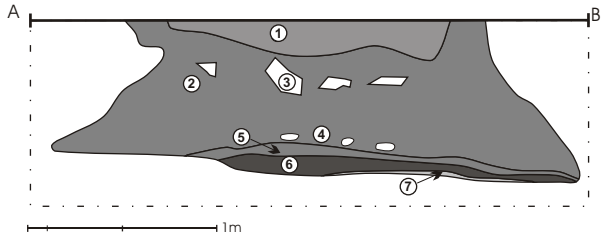
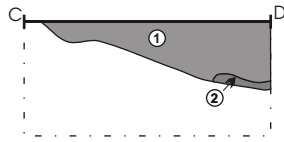
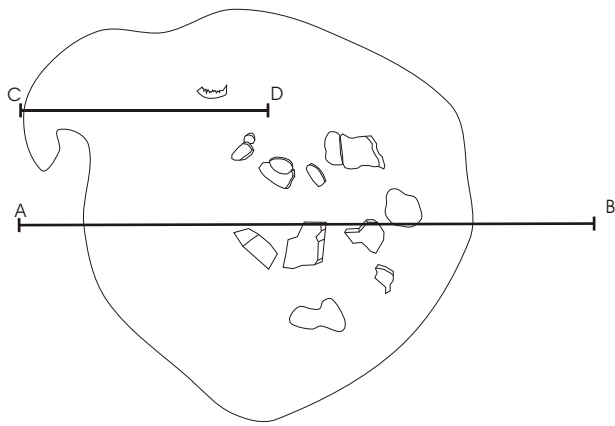

Befund 120

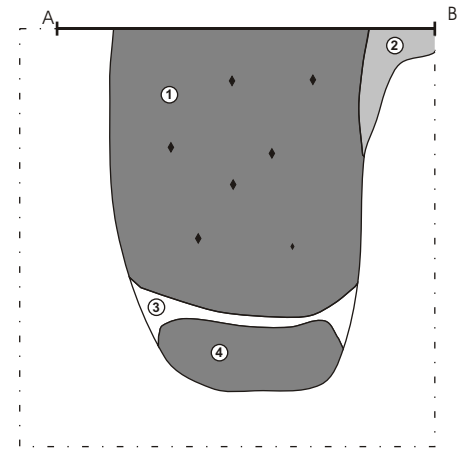

Befund 123

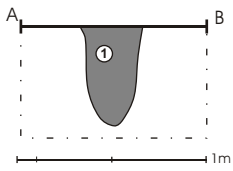

Befund 127

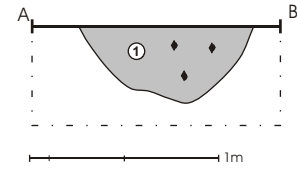
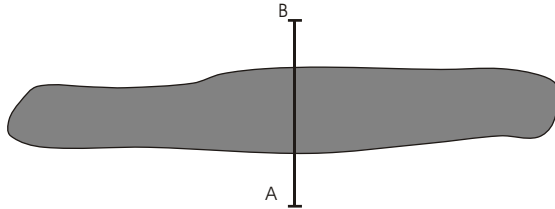

Befund 122

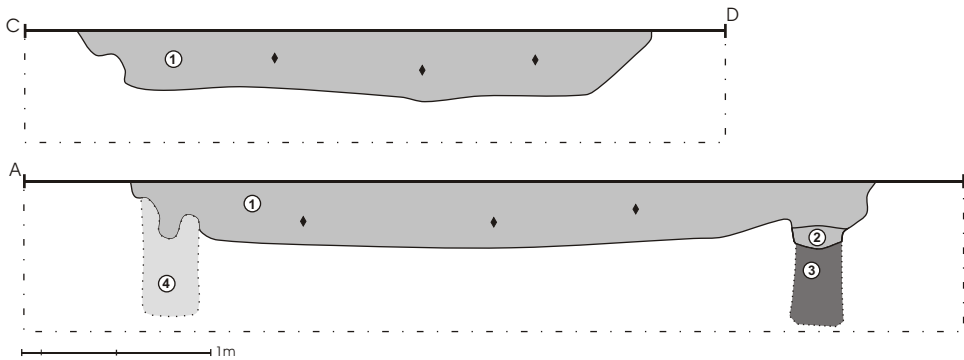

Befund 125

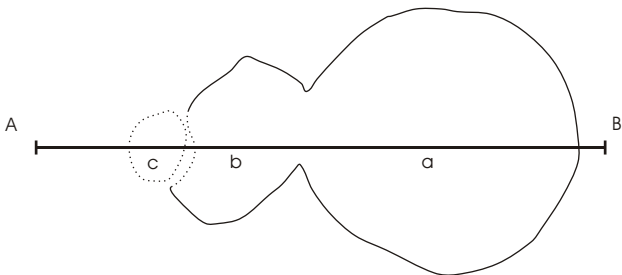
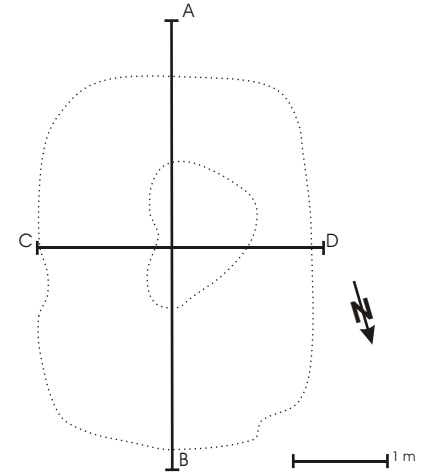

Befund 128

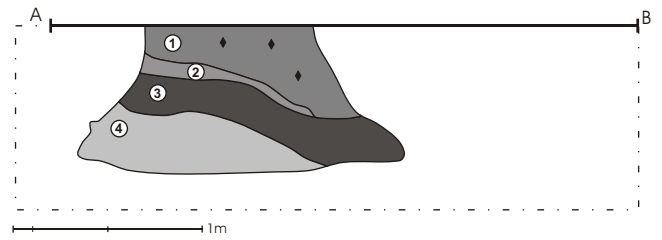

Befund 130

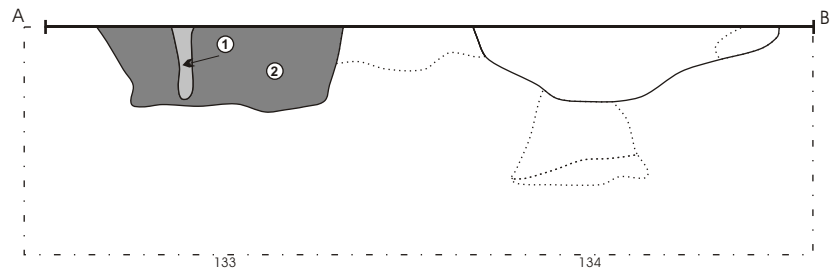

Befund 133

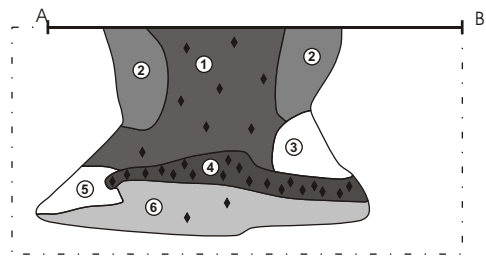

Befund 135

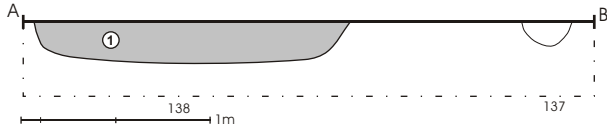

Befund 138

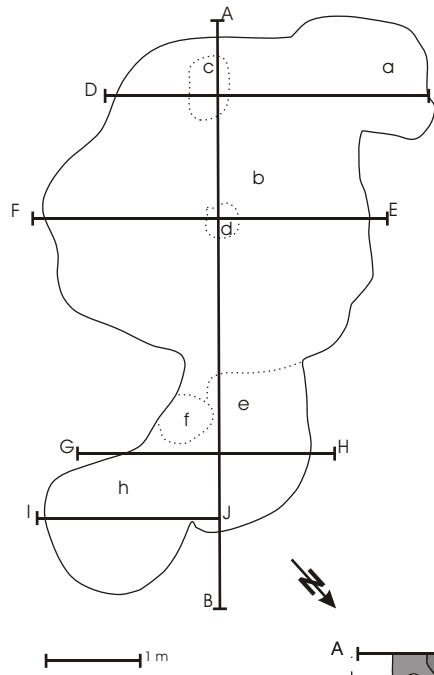
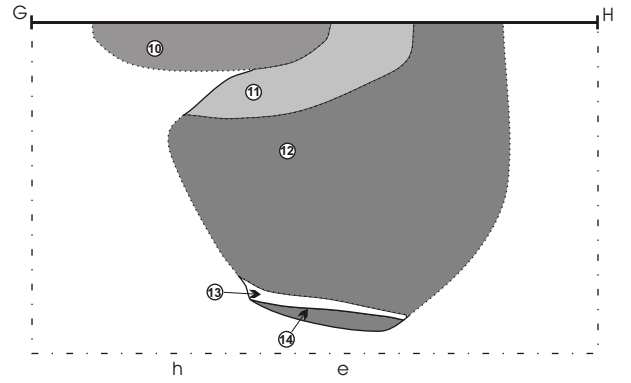
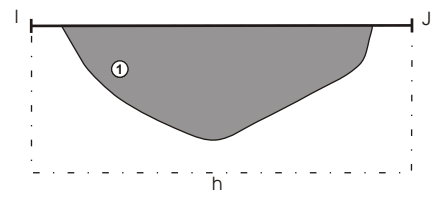

Befund 141

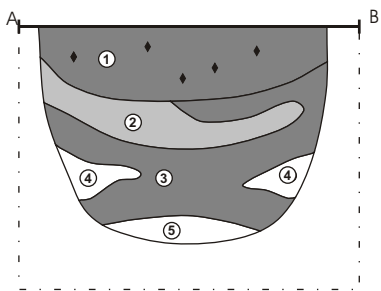
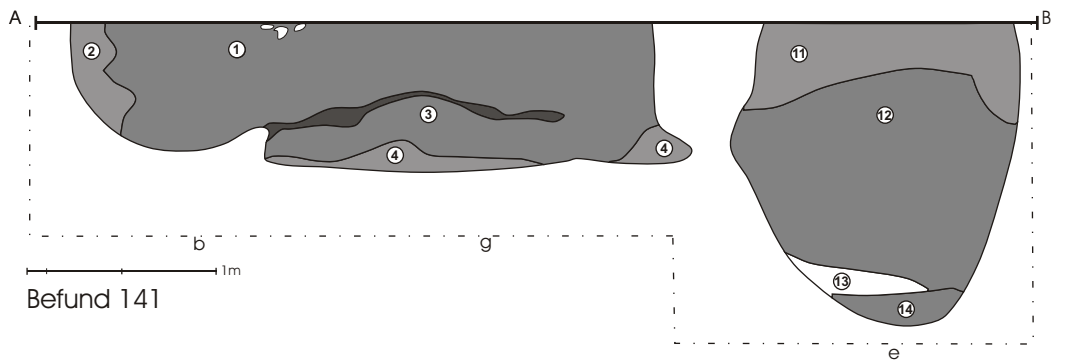
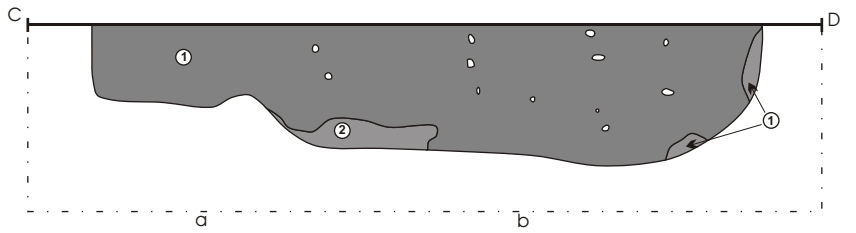
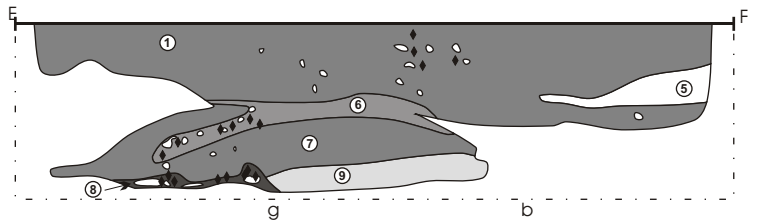

Befund 142

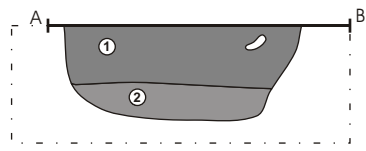

Befund 144

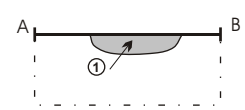

Befund 146

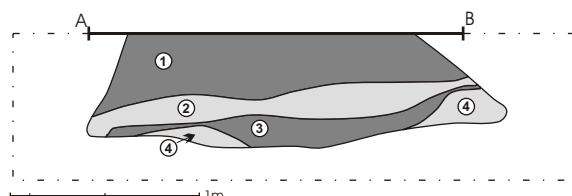

Befund 145

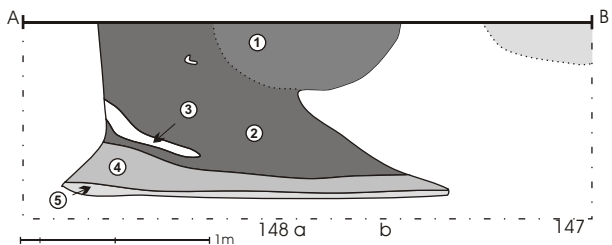

Befund 148 u. 147

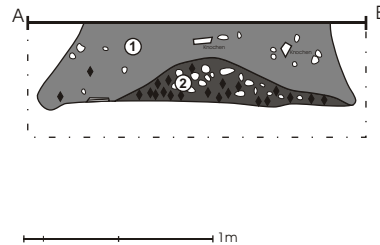

Befund 170

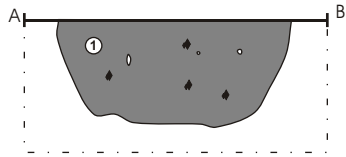

Befund 149

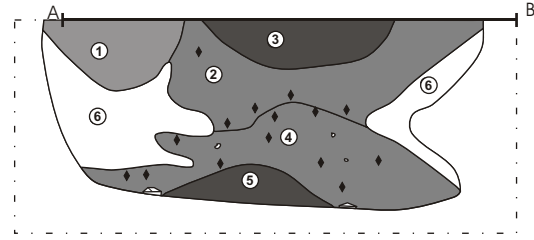

Befund 169

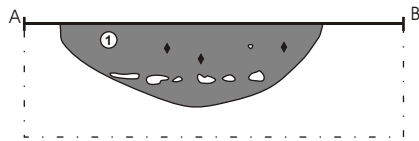

Befund 157

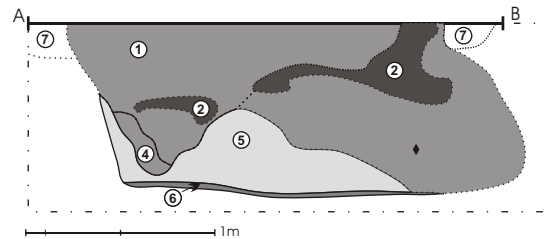

Befund 175

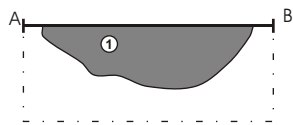

Befund 159

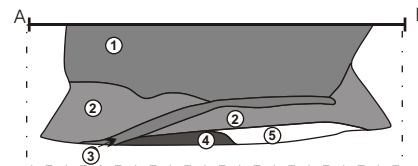

Befund 177

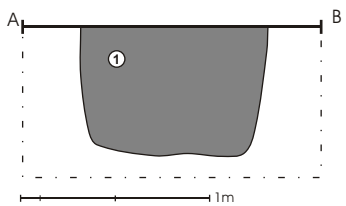

Befund 163

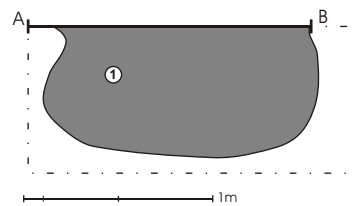

Befund 179

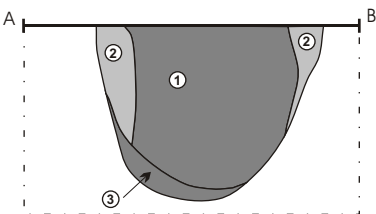

Befund 164

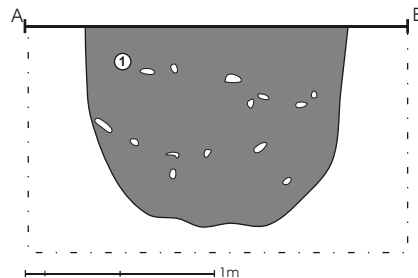

Befund 185

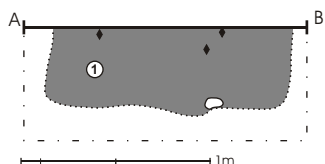

Befund 168

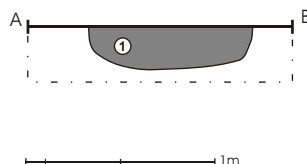

Befund 188

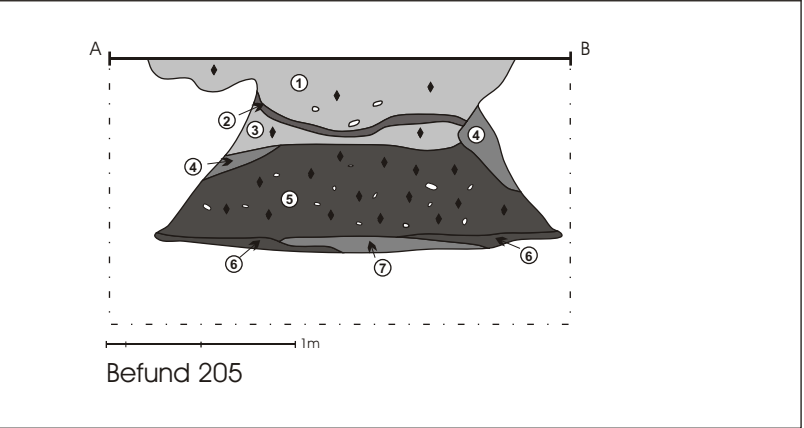
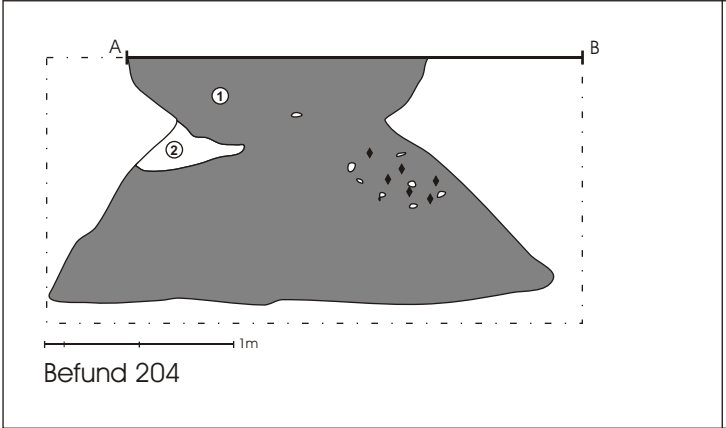
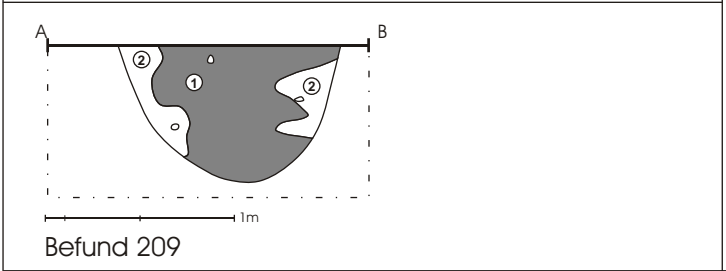
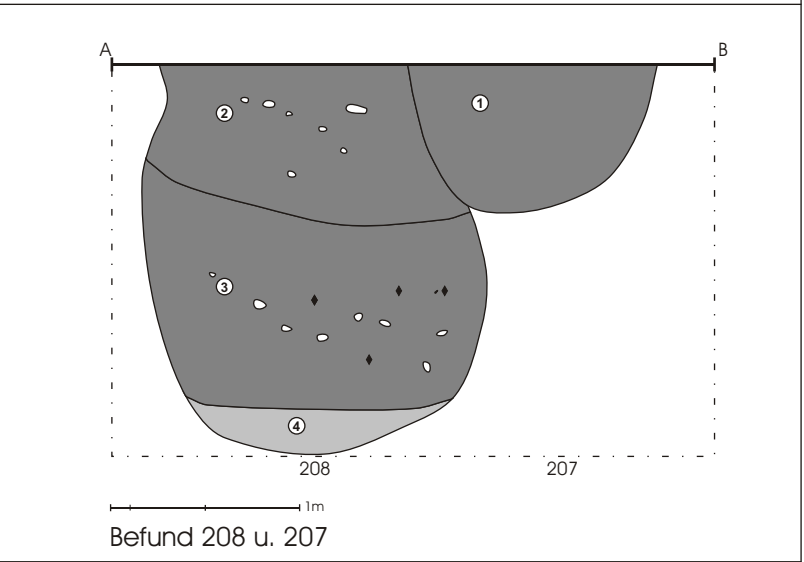
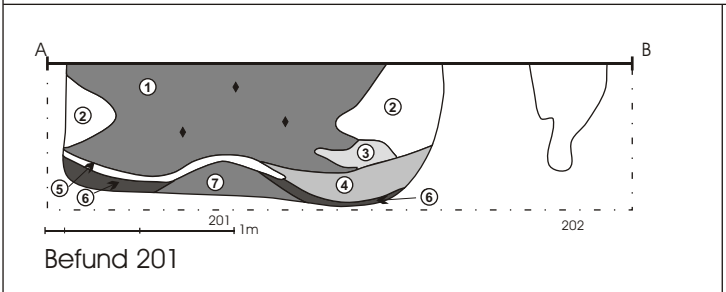
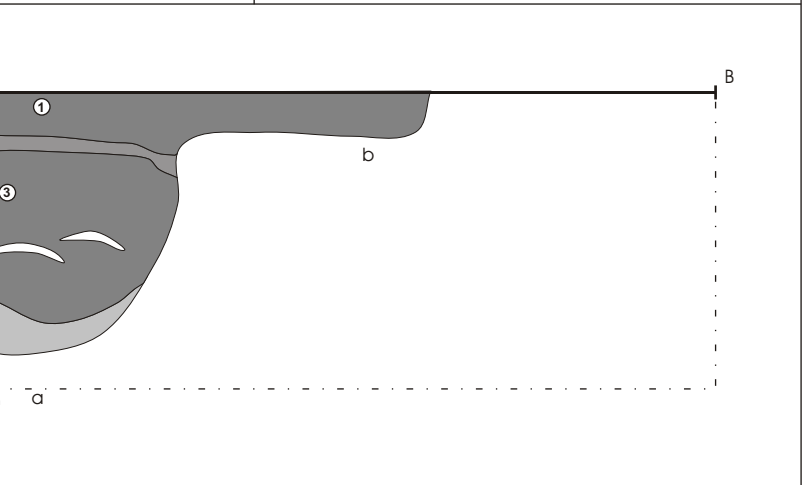
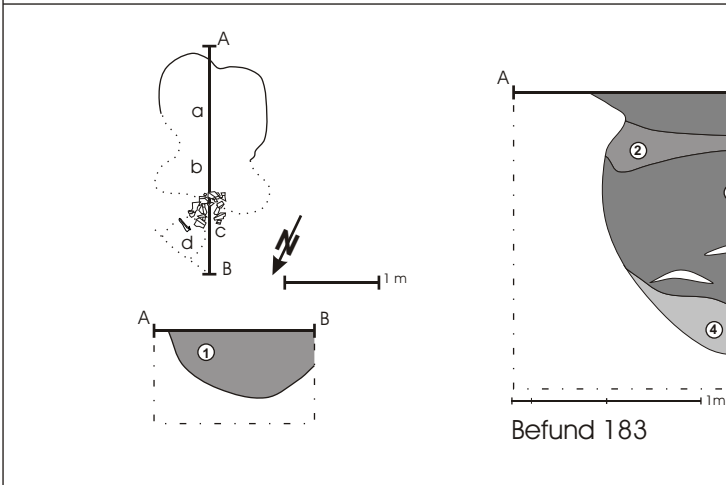
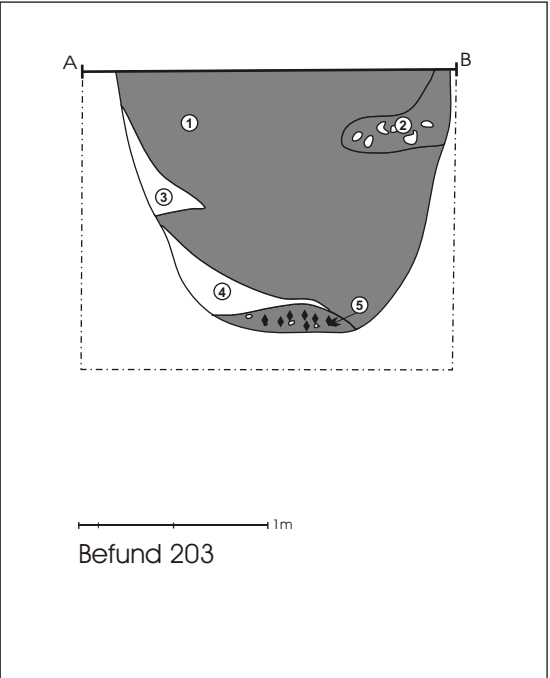
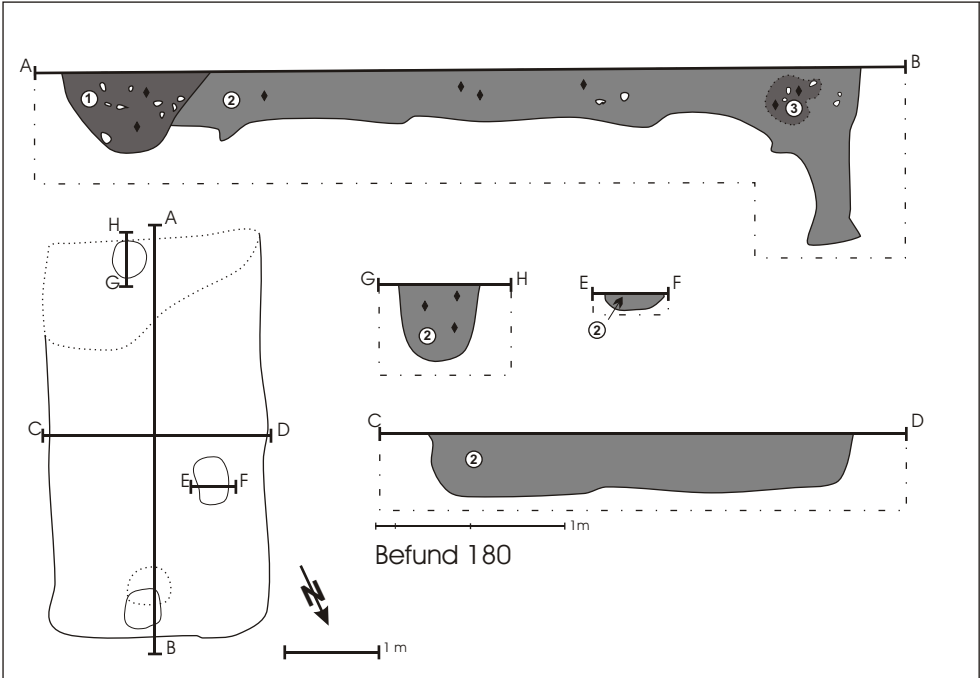

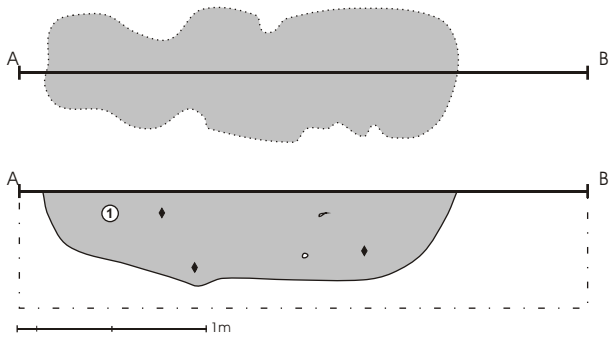

Befund 215

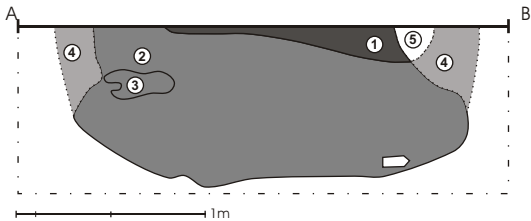

Befund 218

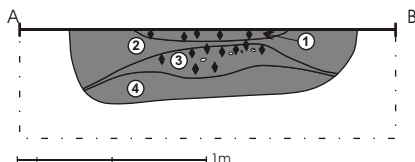

Befund 219

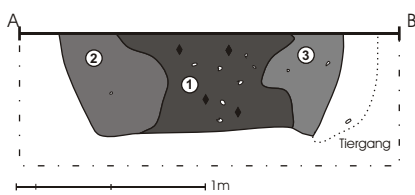

Befund 220

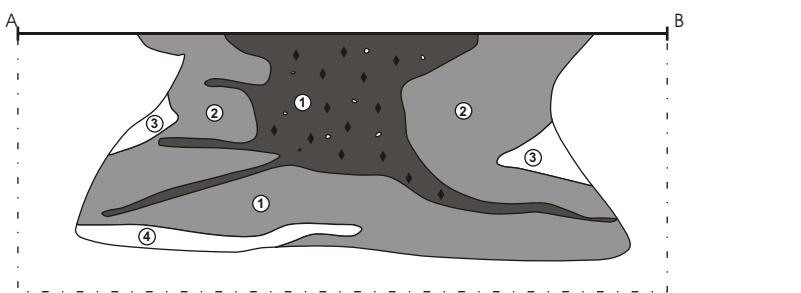

Befund 225

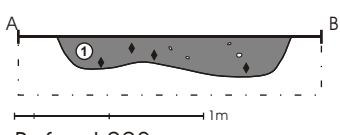

Befund 228

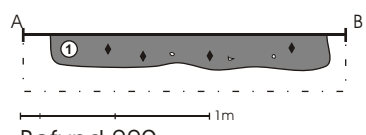

Befund 229

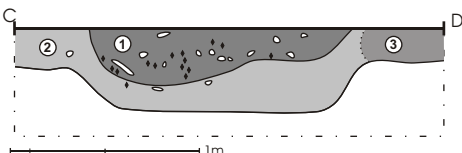
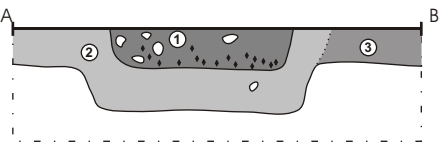
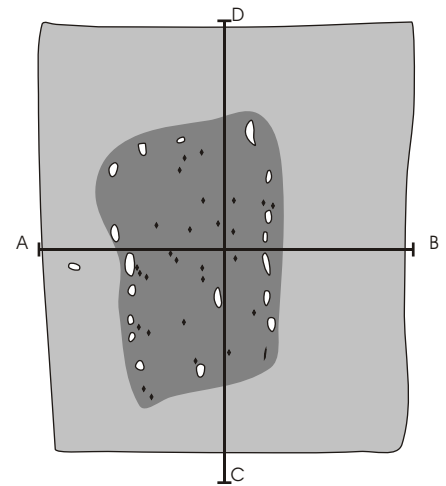

Befund 221

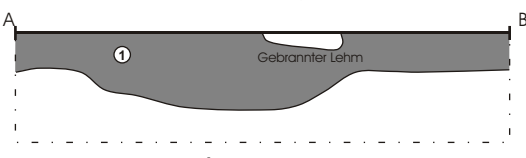
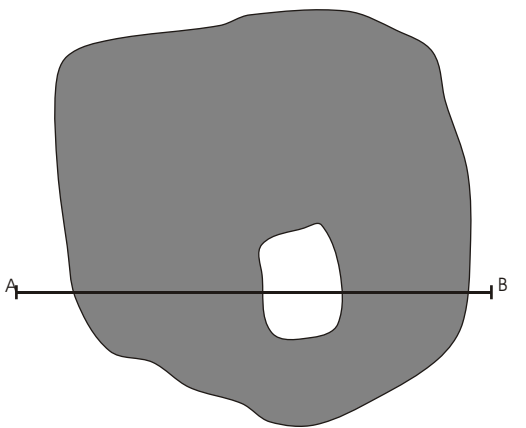

Befund 227

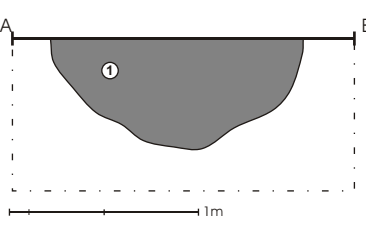

Befund 232

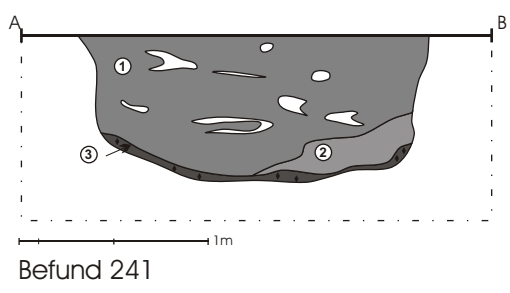
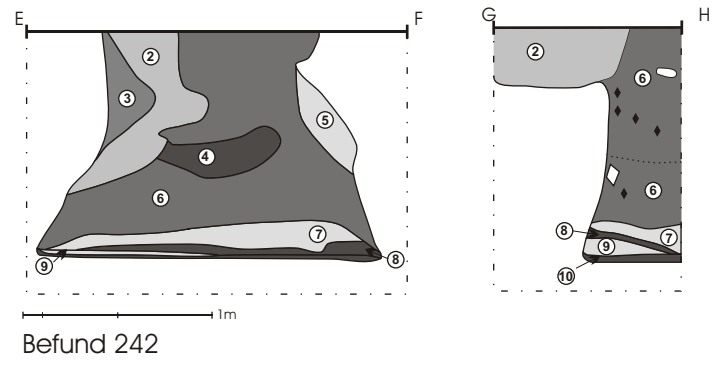
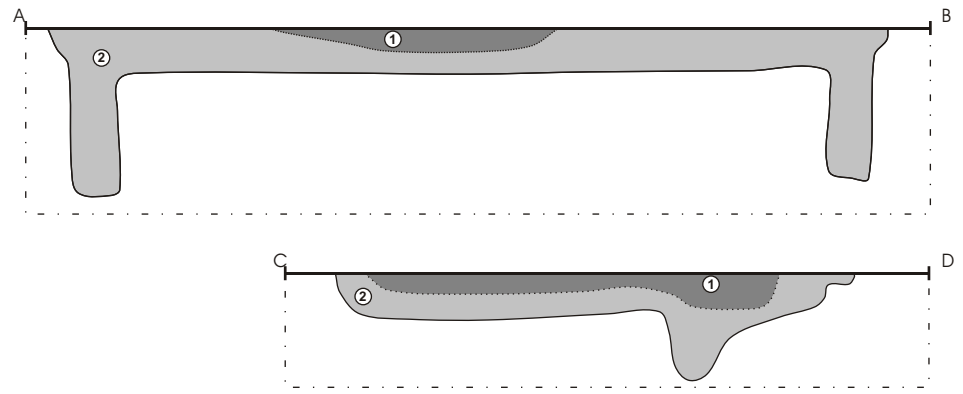
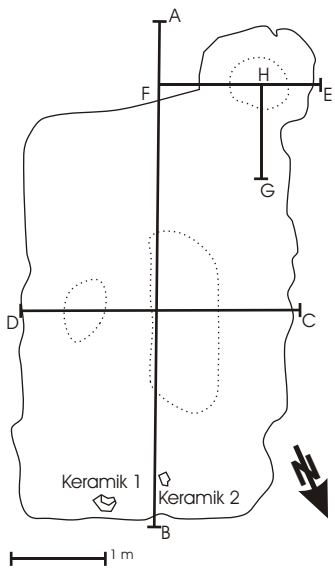

Befund 242

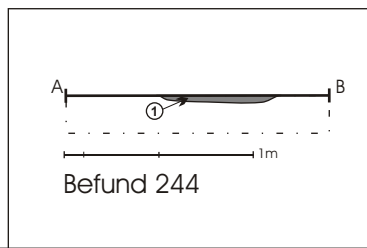
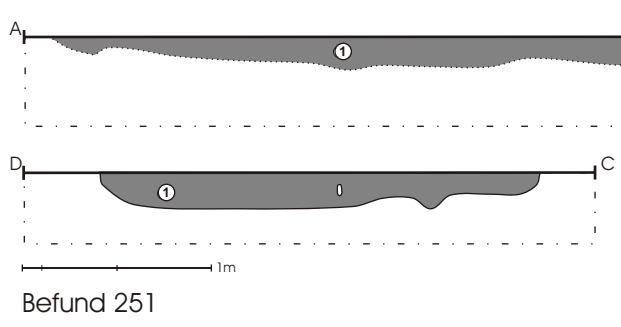
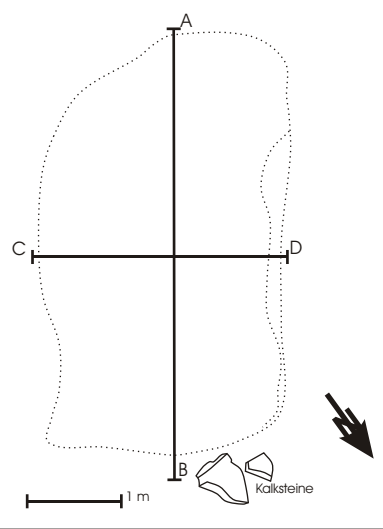
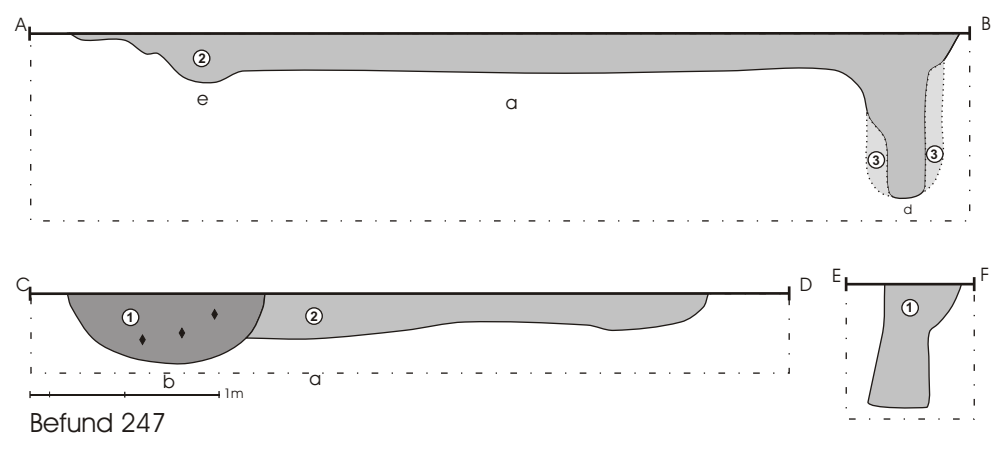
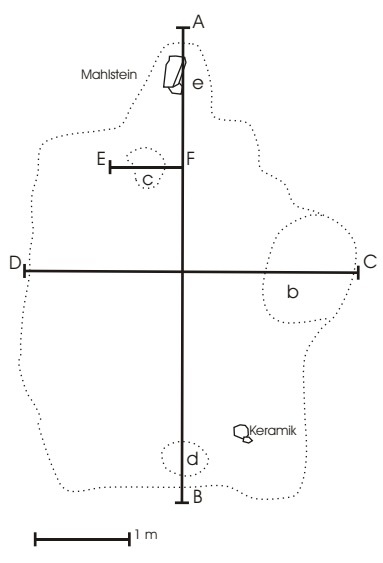

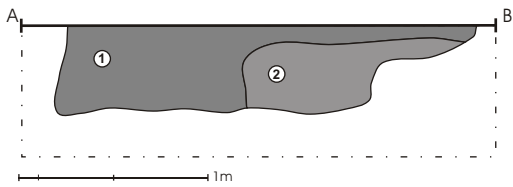

Befund 254

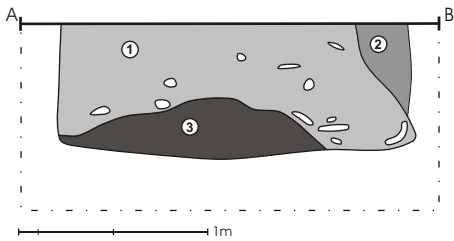

Befund 255

- ♦♦♦ Holzkohle
- ◊ Gebrannter Lehm
- ◻ Stein
- ◻ Lehm
- ◻ Grau/dunkelgelb
- ◻ Hellbraun
- ◻ Mittelbraun/stark gefl. Löß
- ◻ Dunkelbraun
- ◻ Graubraun
- ◻ Schwarzbraun/schwarzgrau
- ◻ Brandschicht

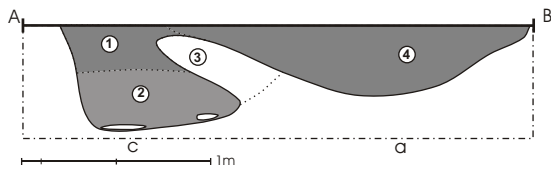
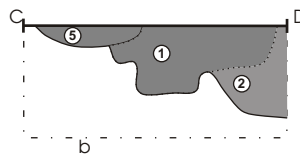
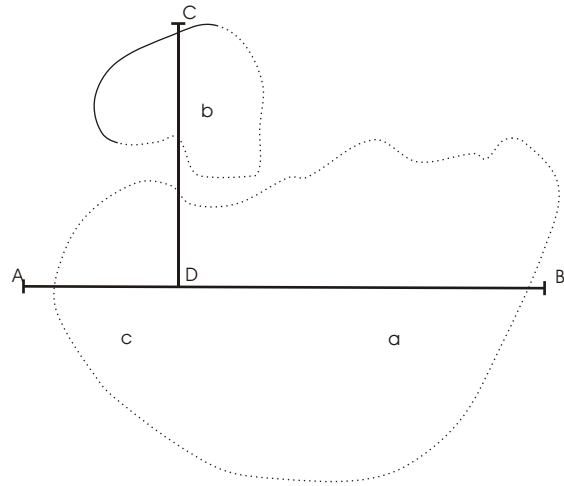

Befund 282