

Tafeln 1–35

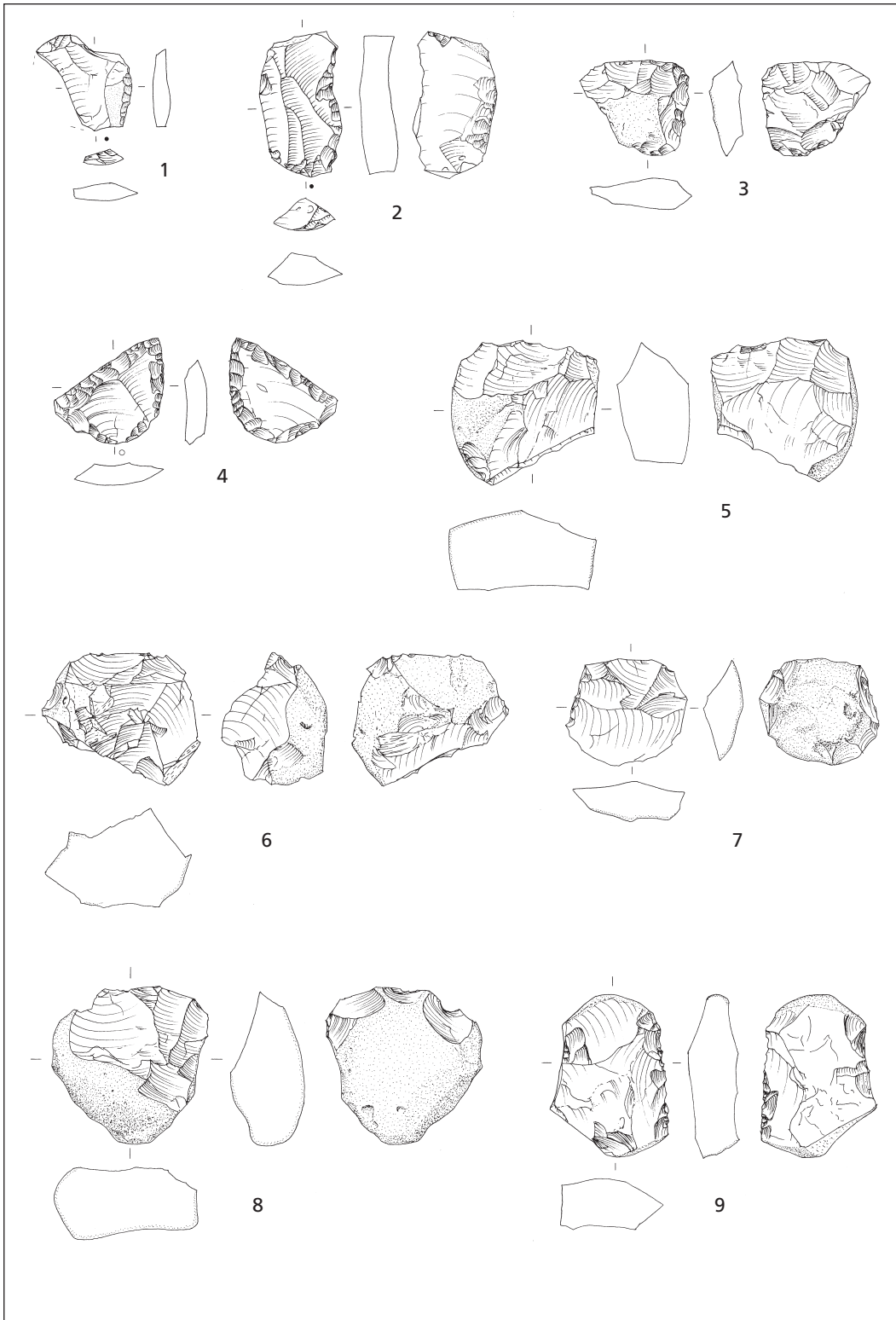

Gemrigheim (Kreis Ludwigsburg). M 1:2.

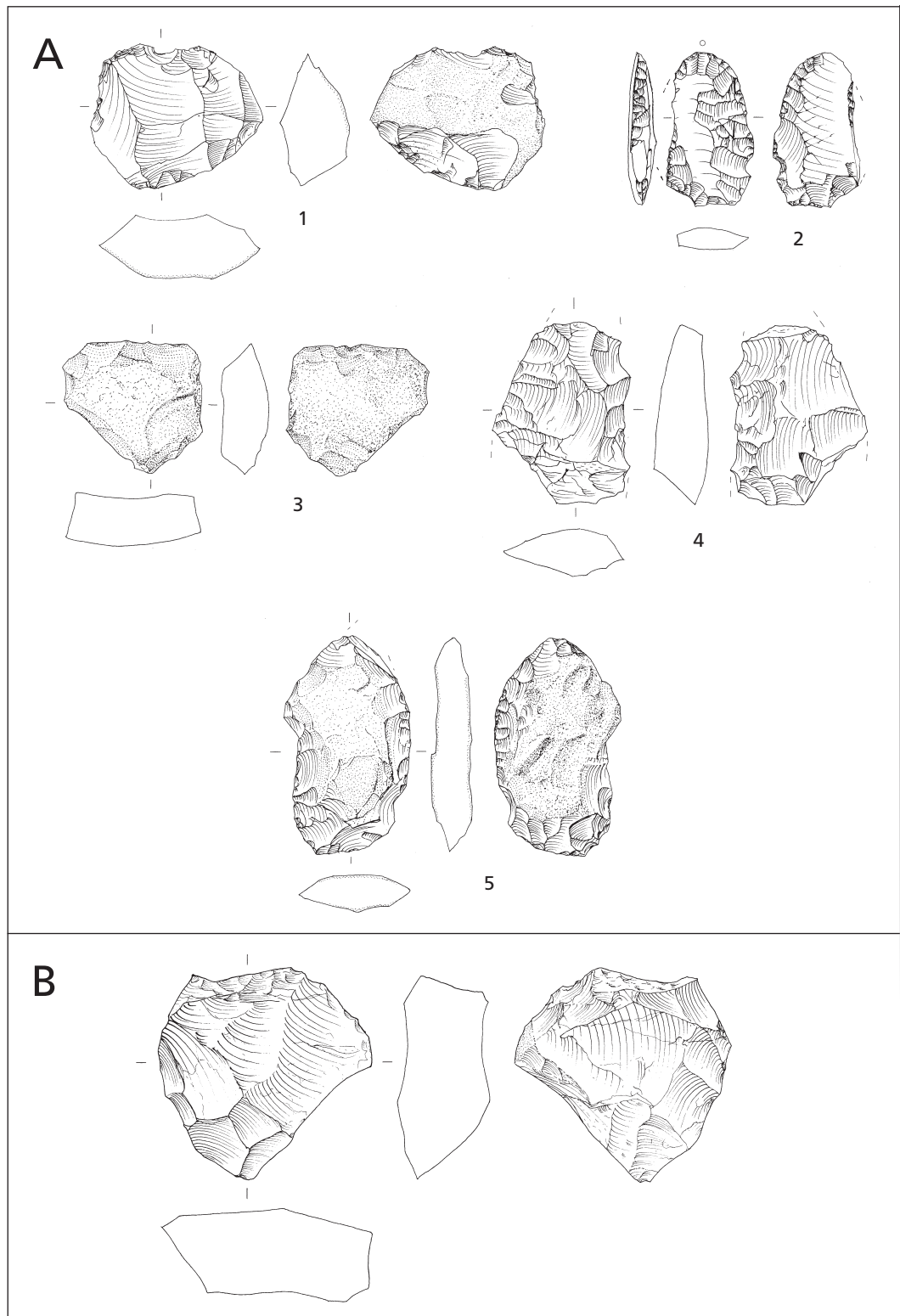

A Gemmrigheim (Kreis Ludwigsburg). M 1:2. – B Lauda-Königshofen (Main-Tauber-Kreis). Fdst. 1. M 1:2.

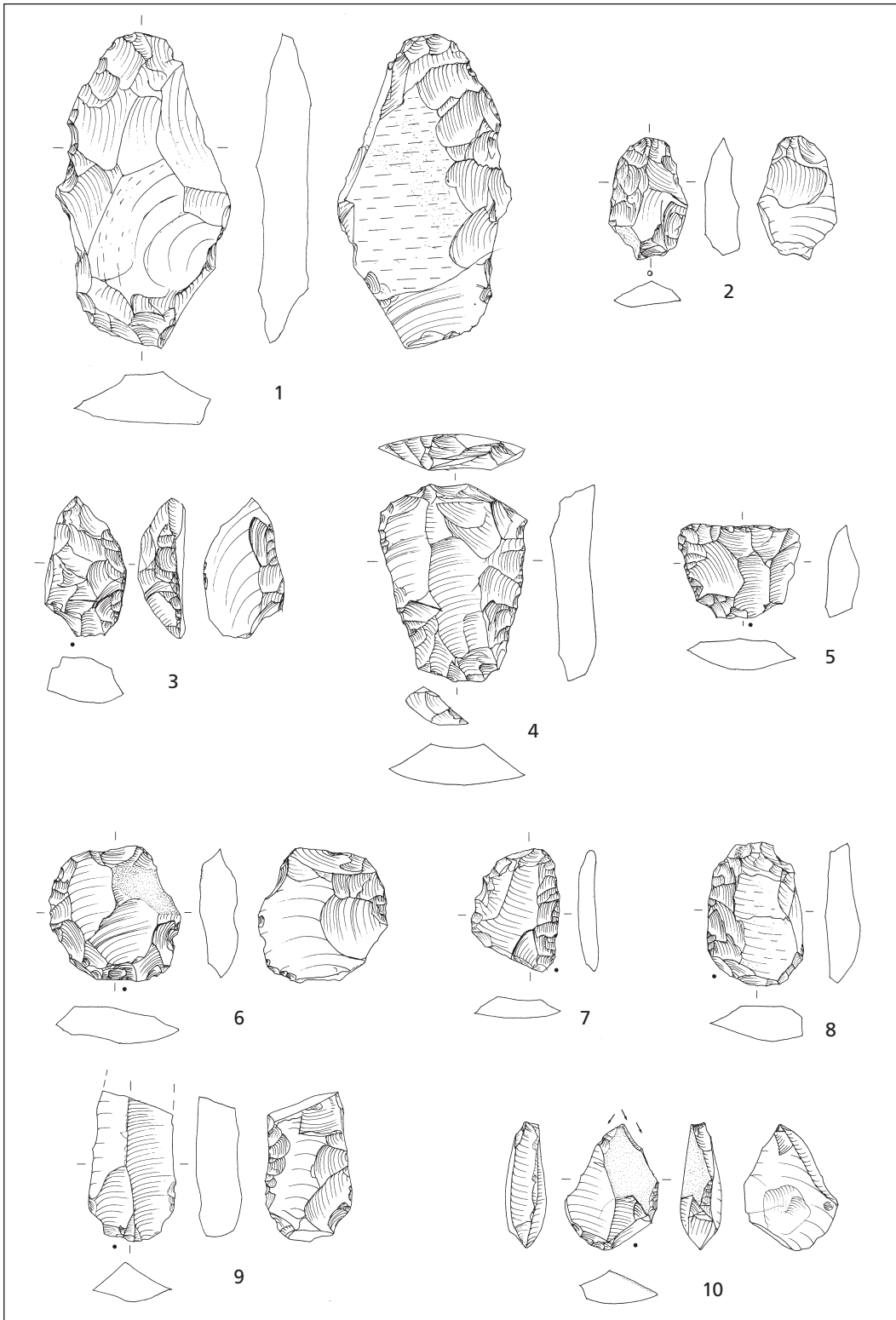

Waldstetten (Ostalbkreis). M 1:2.

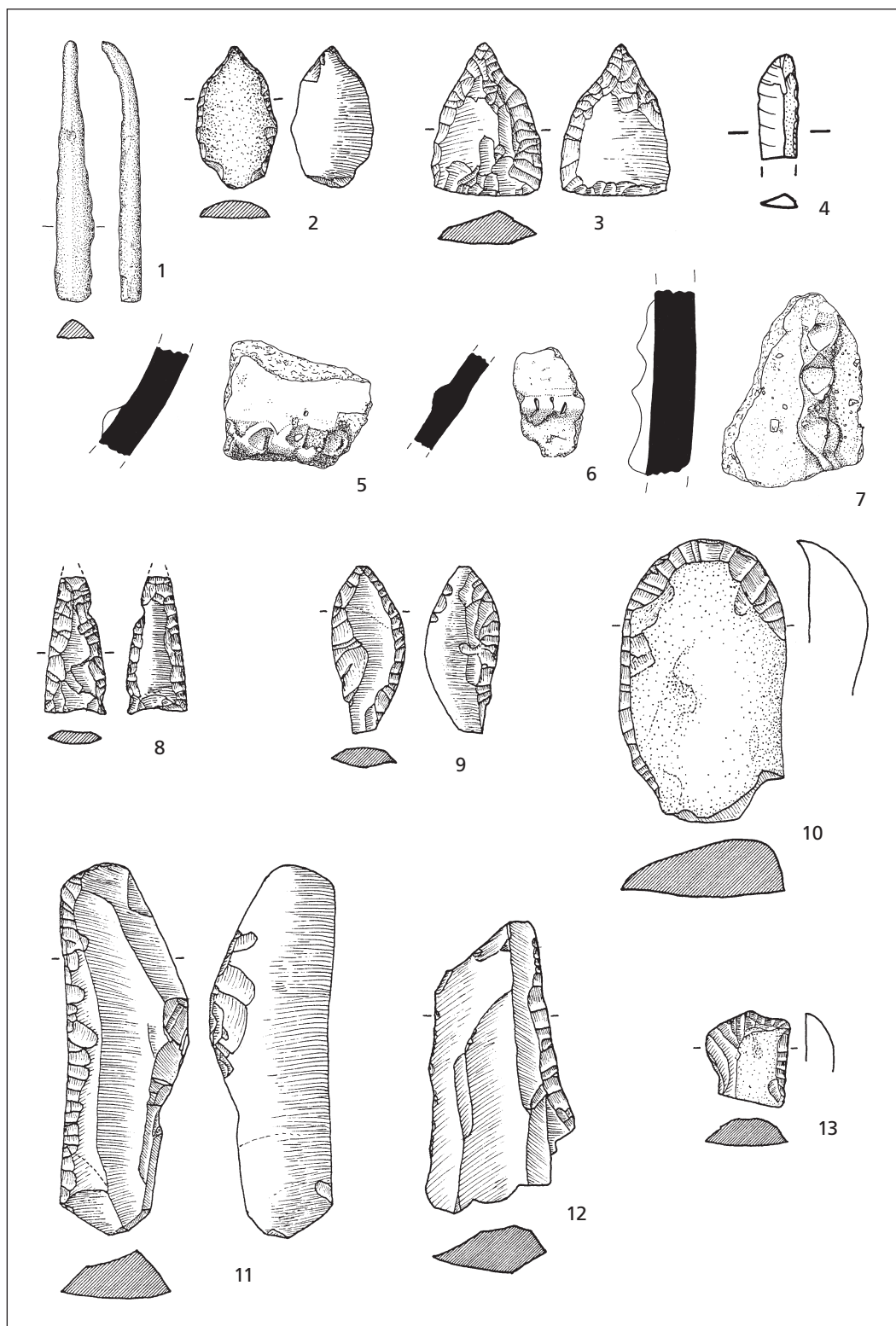

Bad Bellingen H e r t i n g e n (Lkr. Lörrach). 1.2 Fdst. 1; 3 Fdst. 2; 4-13 Fdst. 3.
1.5.6.7 M 1:2; sonst M 2:3.

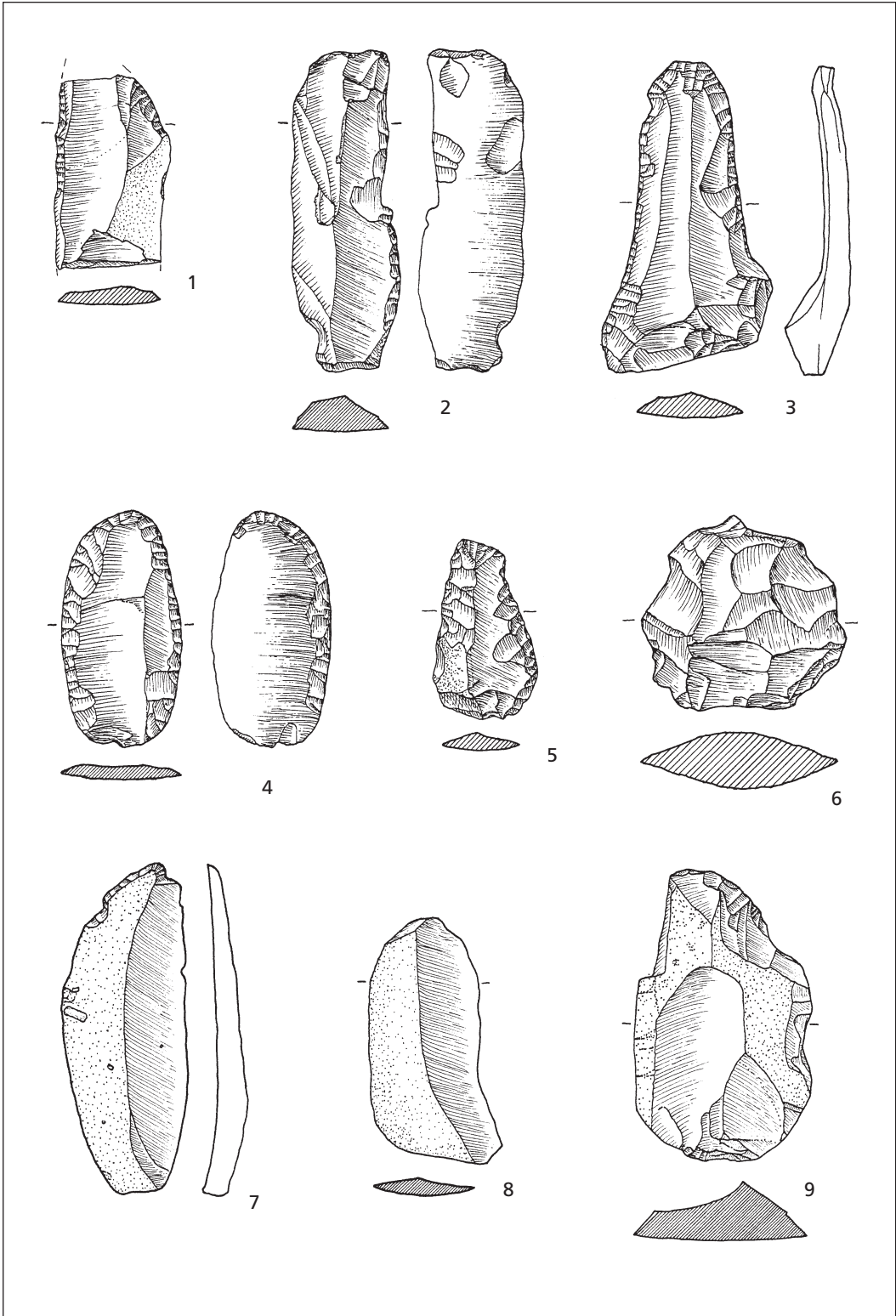

Bad Bellingen Hertingen (Lkr. Lörrach). Fdst. 3. M 2:3.

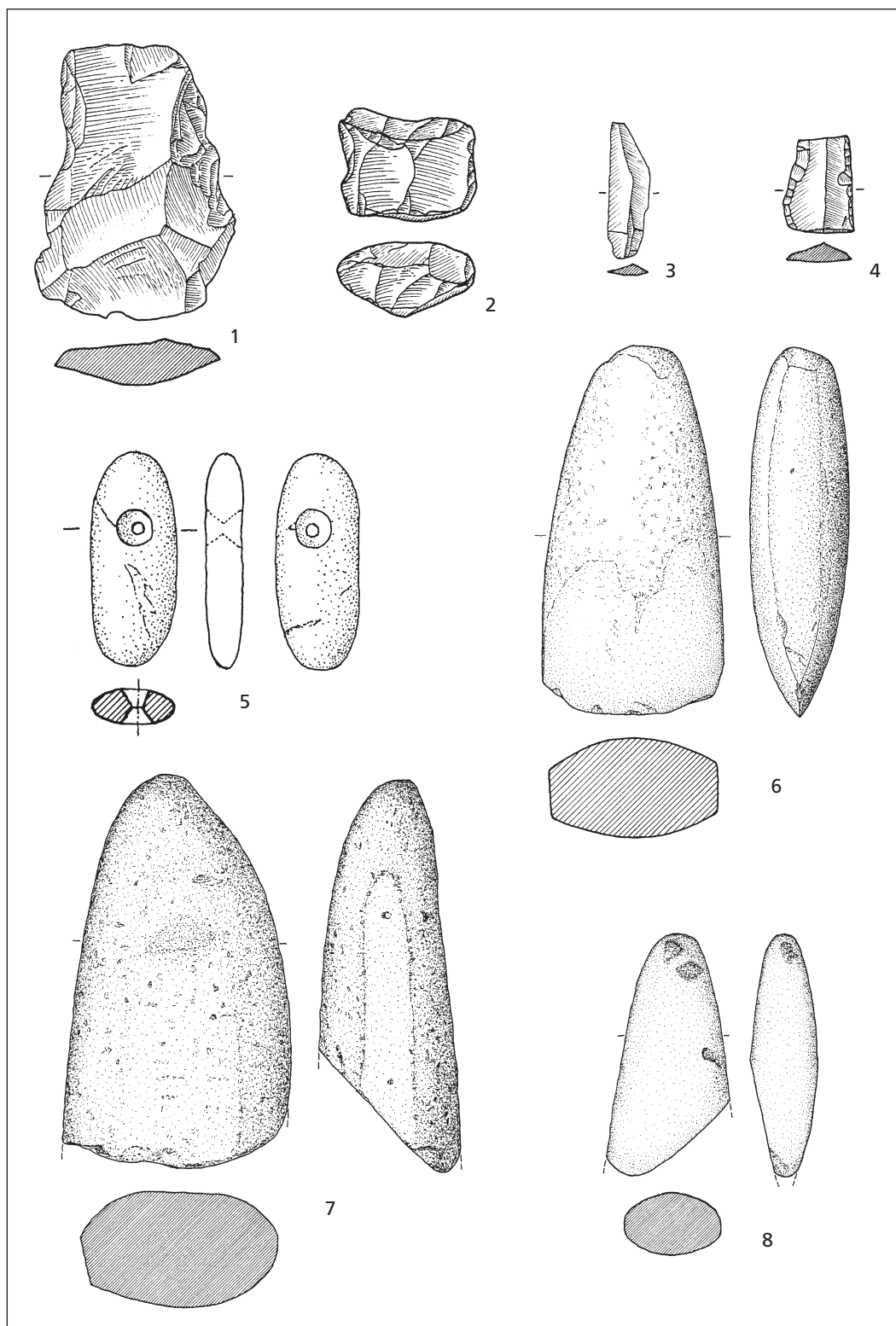

Bad Bellingen H e r t i n g e n (Lkr. Lörrach). Fdst. 3. 1-4 M 2:3; 5 M 1:1; 6-8 M 1:2.

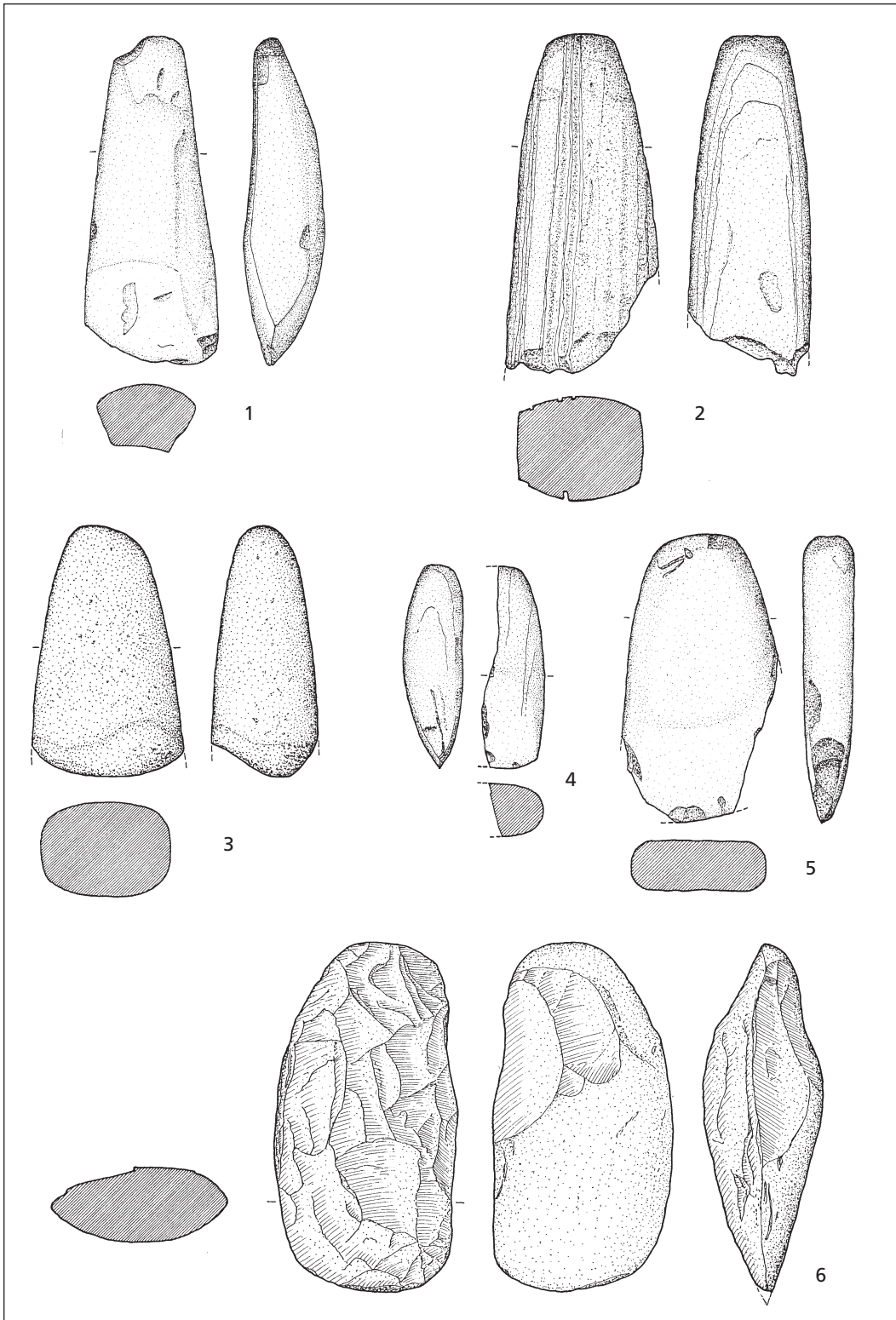

Bad Bellingen Hertingen (Lkr. Lörrach). Fdst. 3. M 1:2.

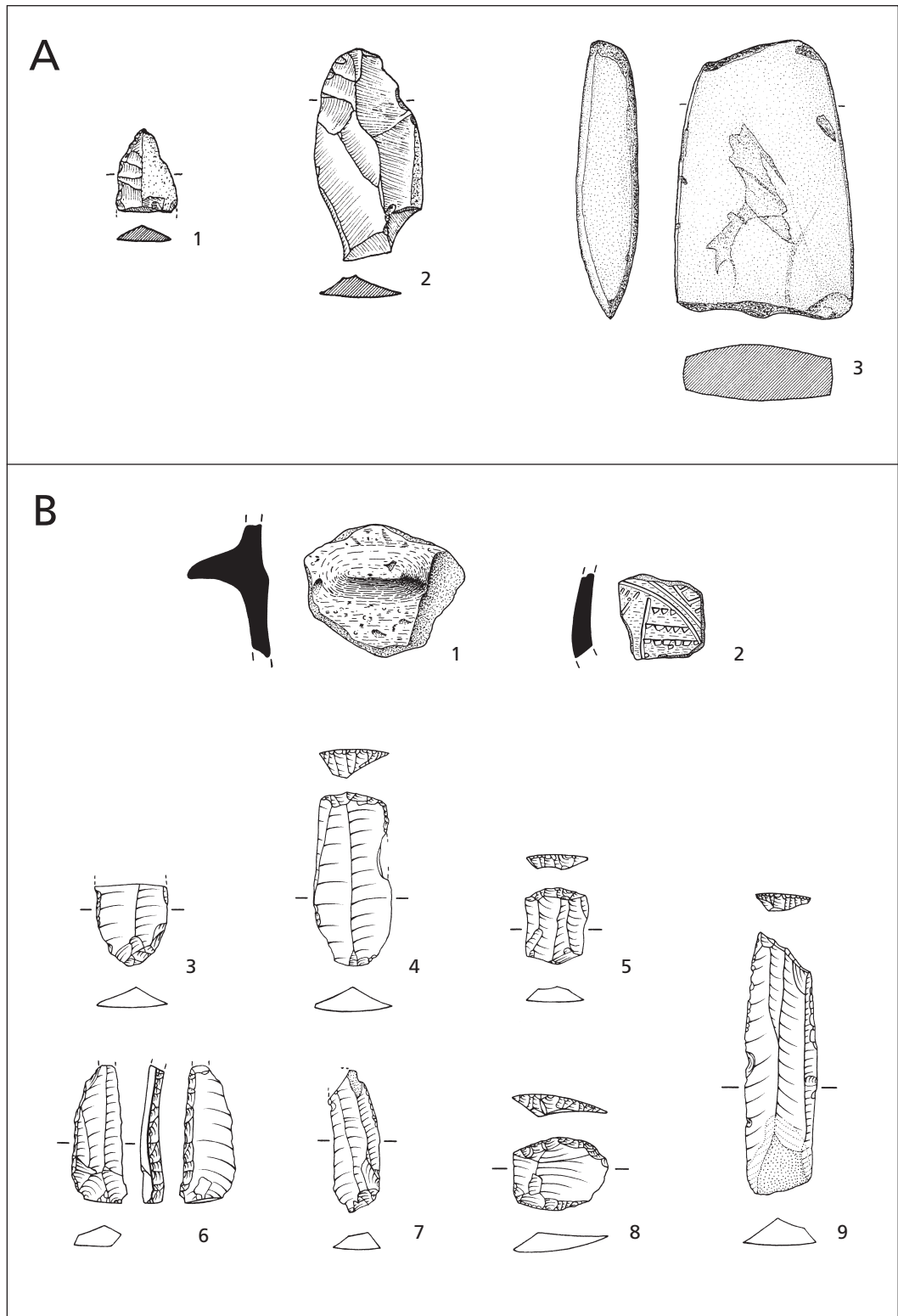

A Bad Bellingen H e r t i n g e n (Lkr. Lörrach). Fdst. 4. 1.2 M 2:3; 3 M 1:2. – B Empfinger
(Lkr. Freudenstadt). 1.2 M 1:2; sonst M 2:3.

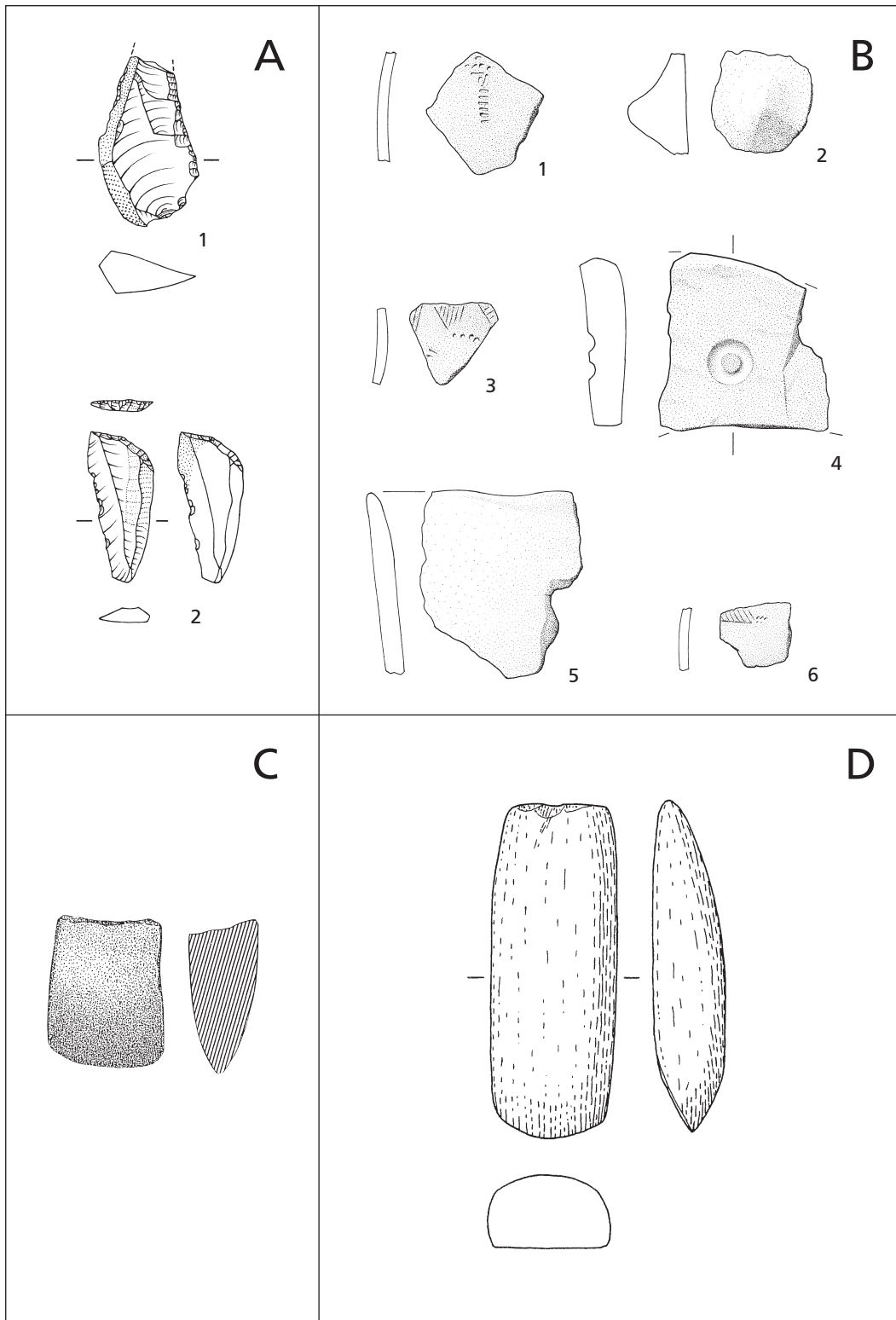

A Empfingen (Lkr. Freudenstadt). M 2:3. – B Endingen (Lkr. Emmendingen). M 1:3. – C Hirschberg an der Bergstraße G r o ß s a c h s e n (Rhein-Neckar-Kreis). M 1:2. – D wie C L e u t e r s h a u s e n. M 1:2.

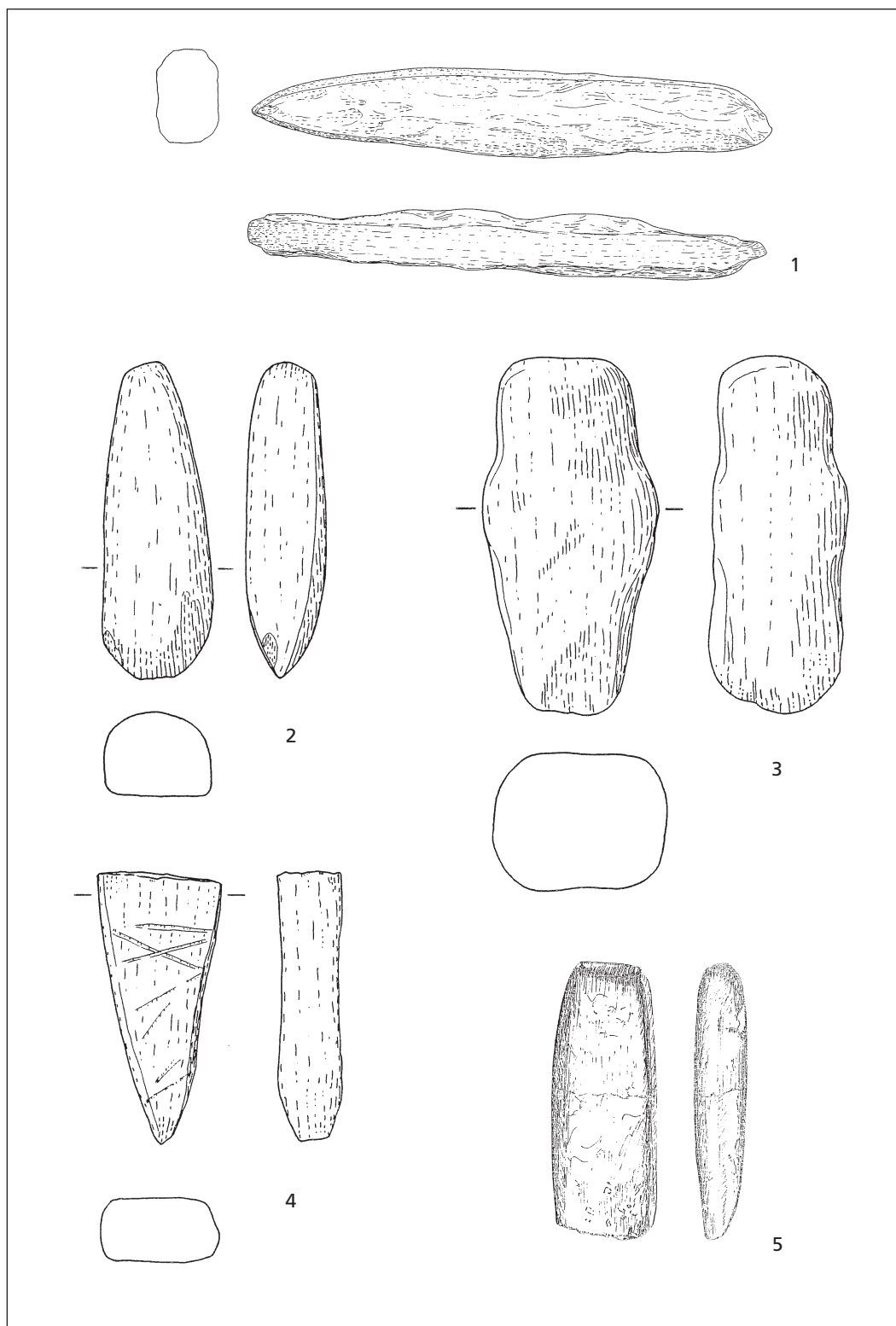

Hirschberg an der Bergstraße Leutershausen (Rhein-Neckar-Kreis).
1 M 1:3; sonst M 1:2.

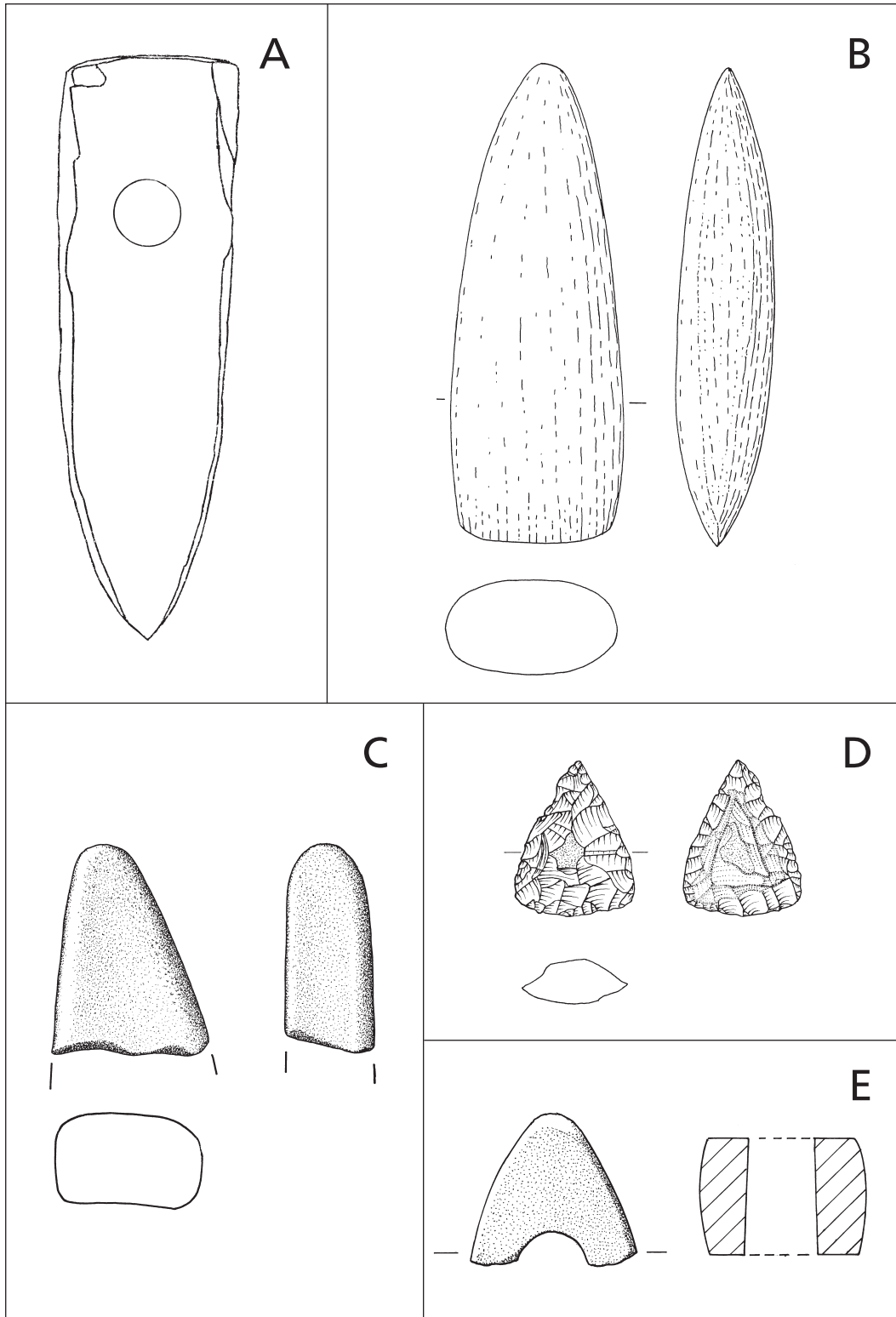

A Hirschberg an der Bergstraße Leutershausen (Rhein-Neckar-Kreis). M 1:2. – B Schriesheim (Rhein-Neckar-Kreis). M 1:2. – C Rheinfelden Minseln (Lkr. Lörrach). M 1:2. – D Schömberg (Zollernalbkreis). M 2:3. – E Schwörstadt (Lkr. Lörrach). M 1:2.

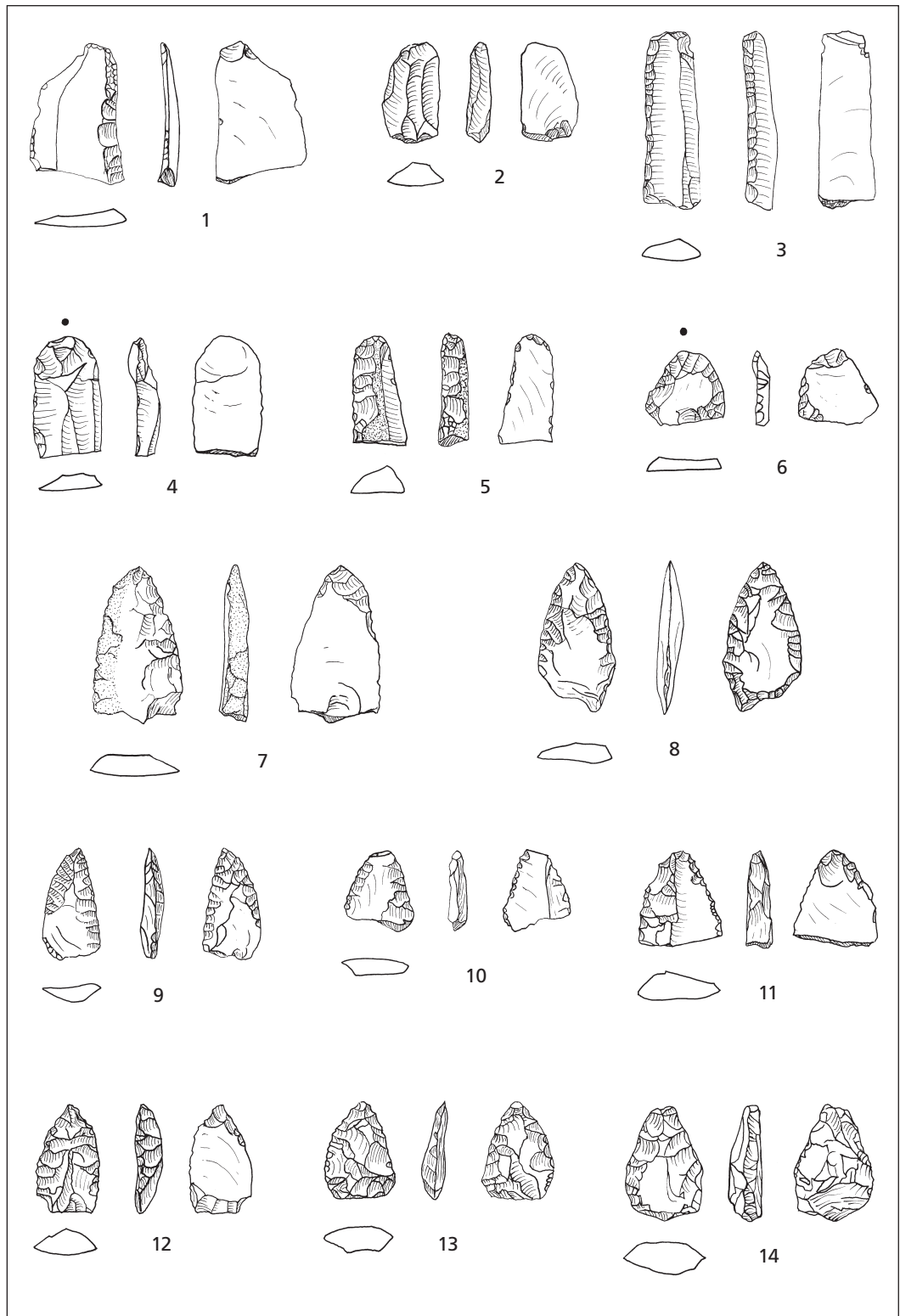

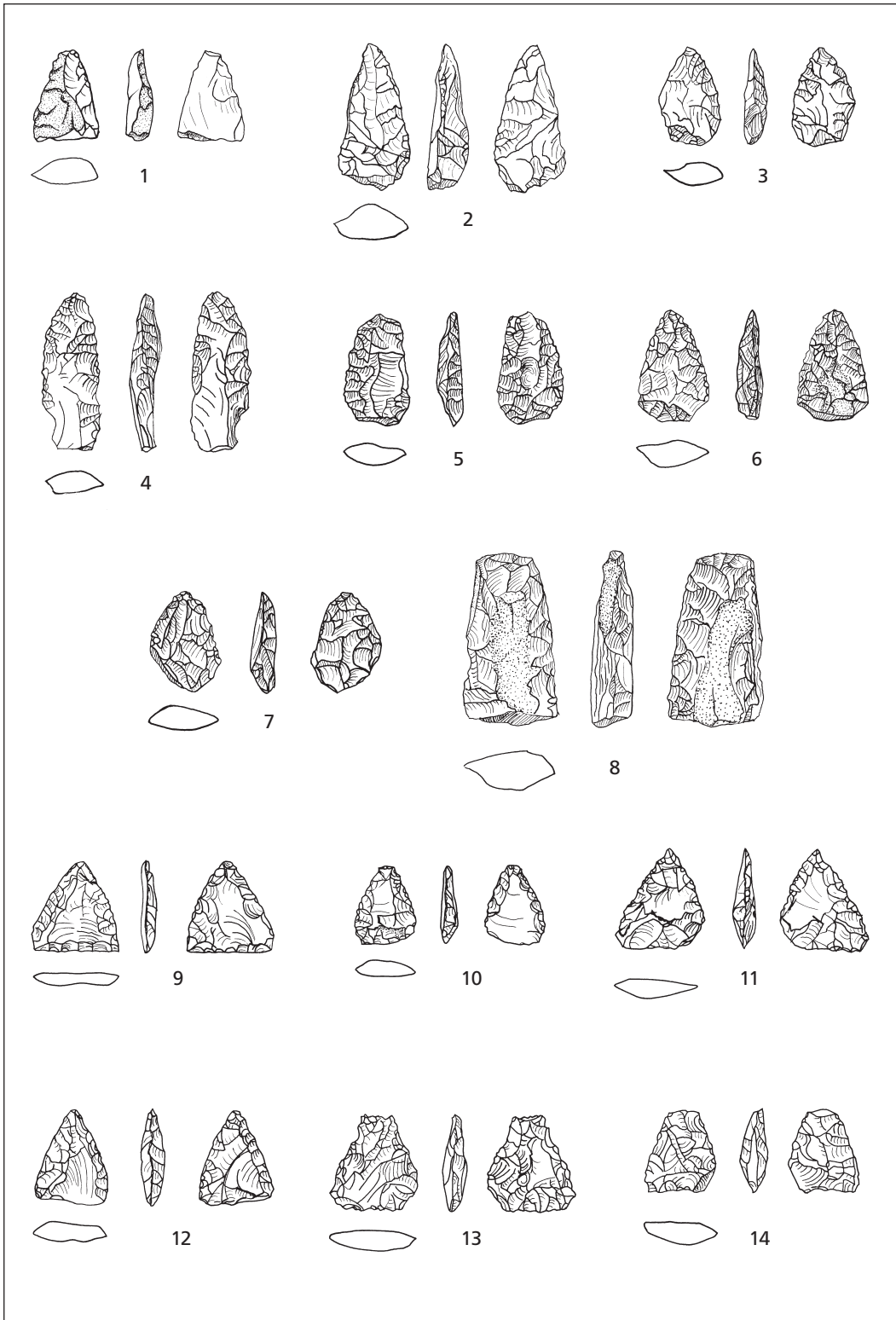

Spaichingen (Lkr. Tuttlingen). M 2:3.

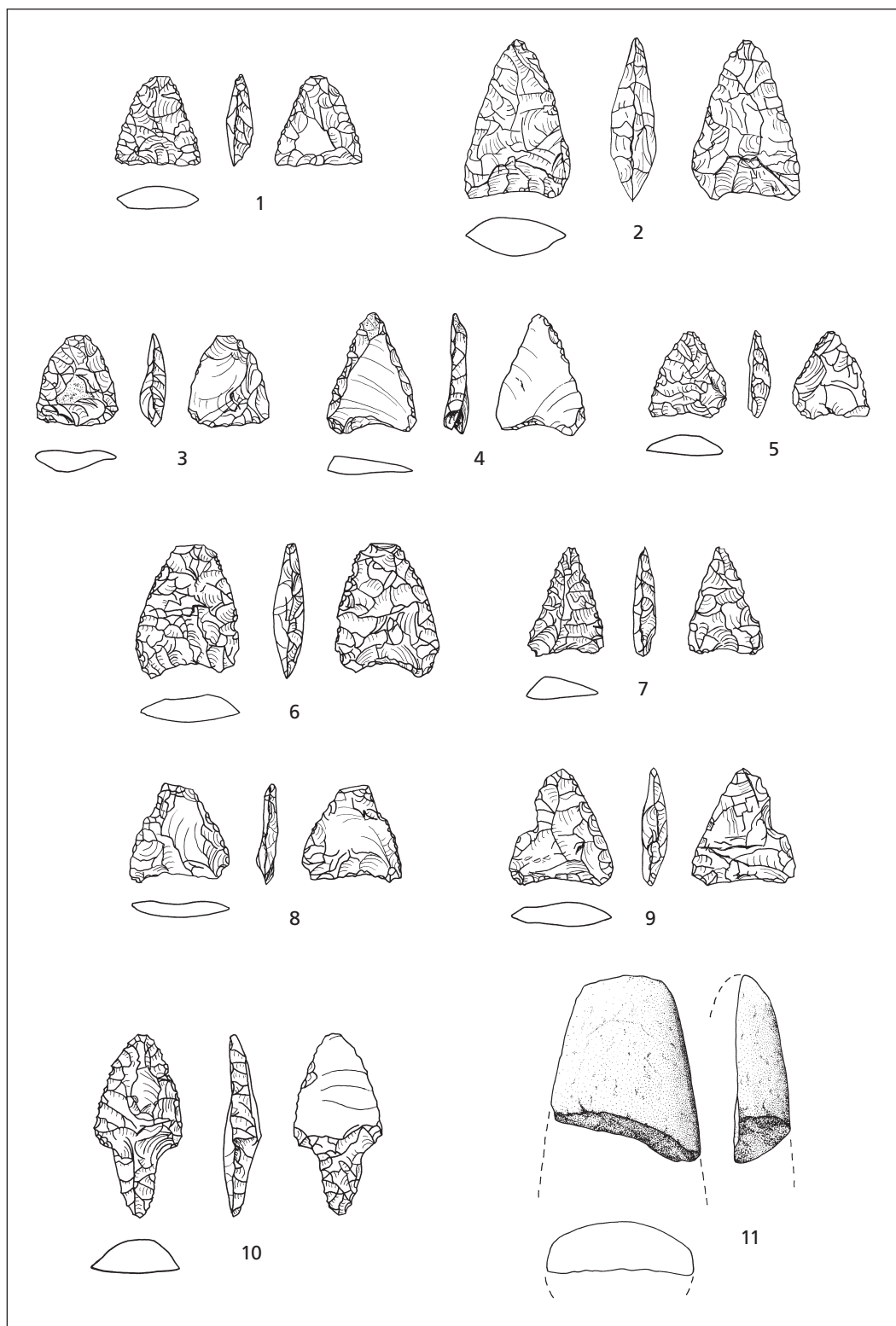

Spaichingen (Lkr. Tuttlingen). 11 M 1:2; sonst M 2:3.

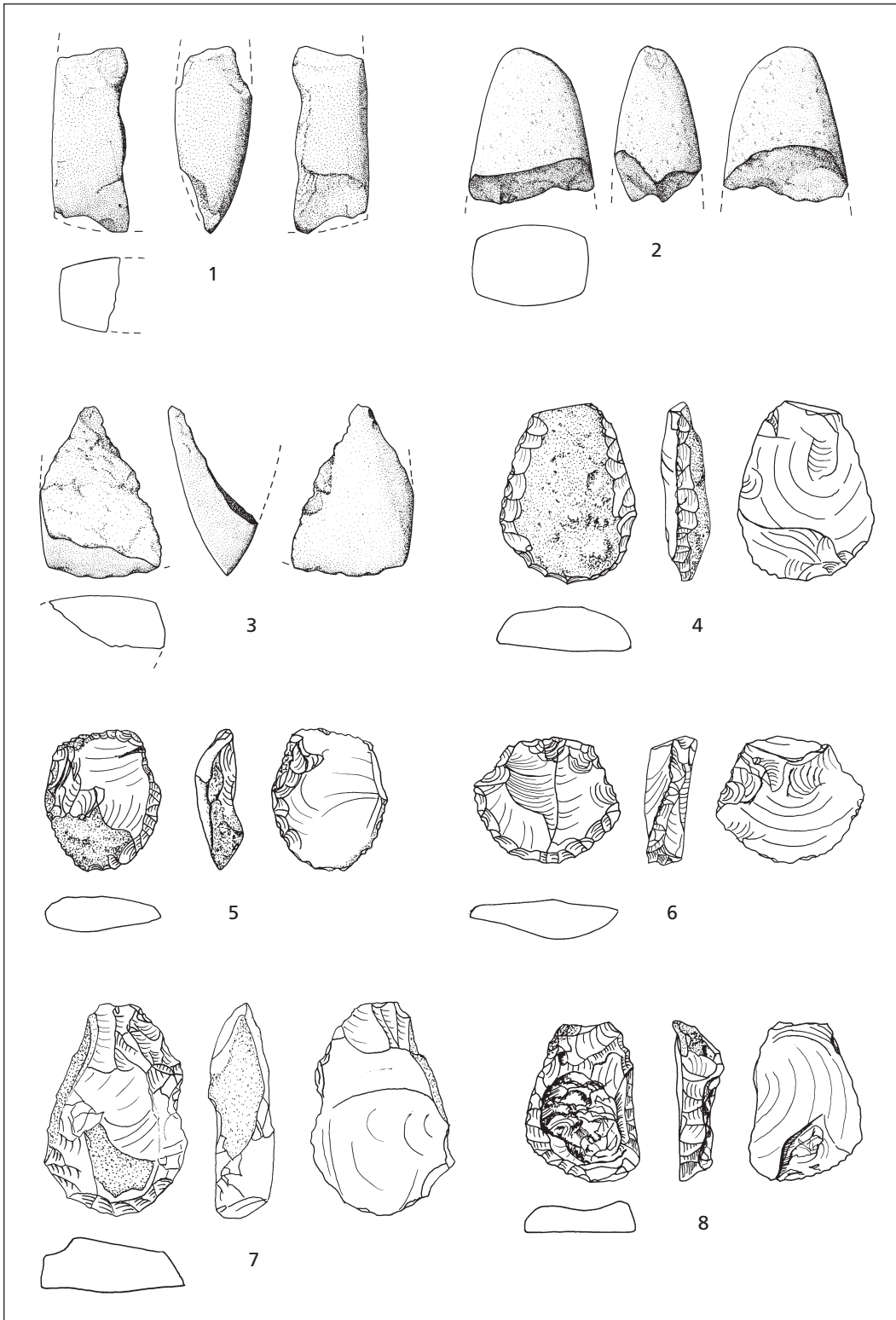

Spaichingen (Lkr. Tuttlingen). 1-3 M 1:2; sonst M 2:3.

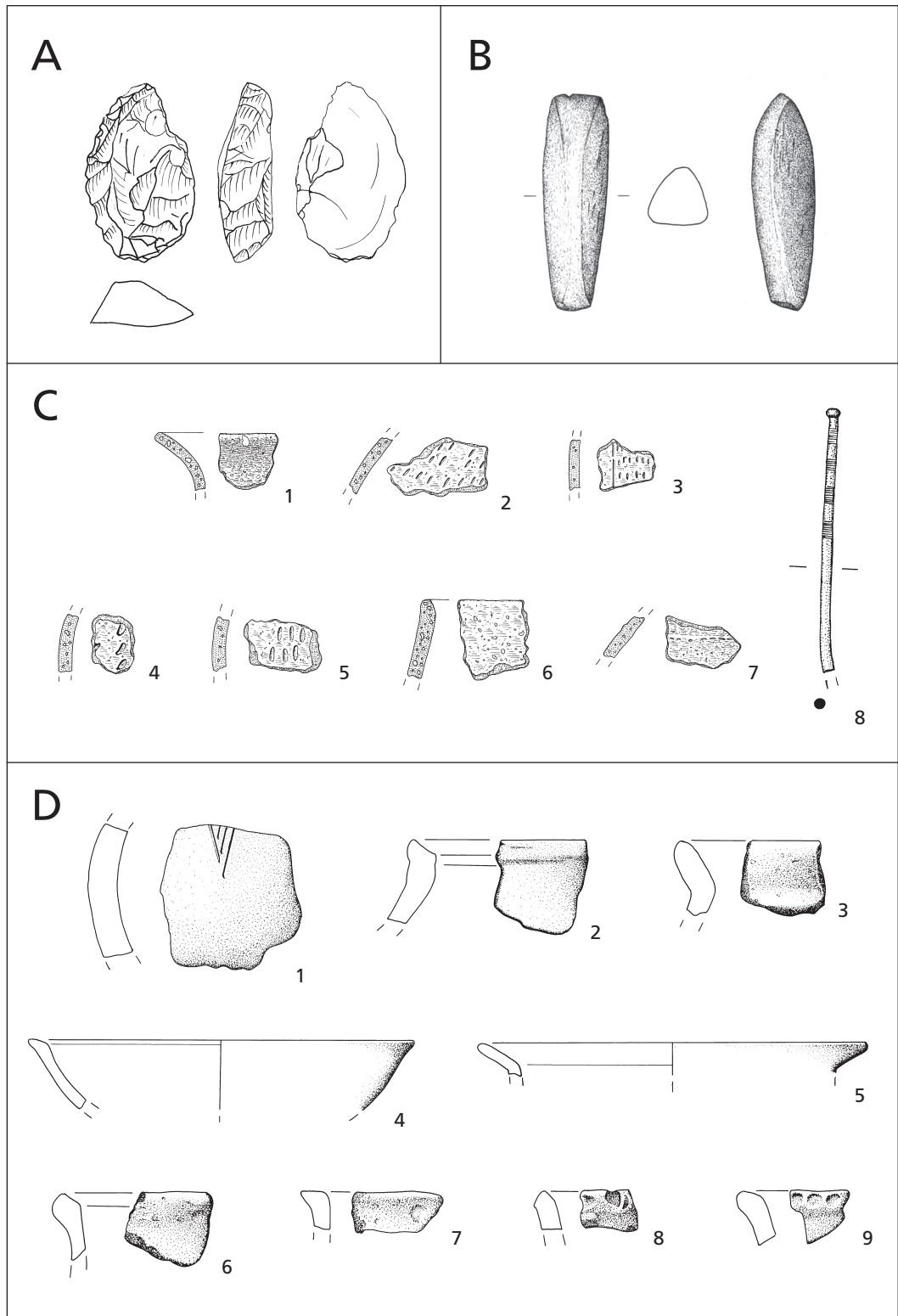

A Spaichingen (Lkr. Tuttlingen). M 2:3. – B Untergruppenbach (Lkr. Heilbronn). Fdst. 2. M 1:2. – C Buchheim (Lkr. Tuttlingen). 8 M 2:3; sonst M 1:3. – D Sasbach (Lkr. Emmendingen). M 1:3.

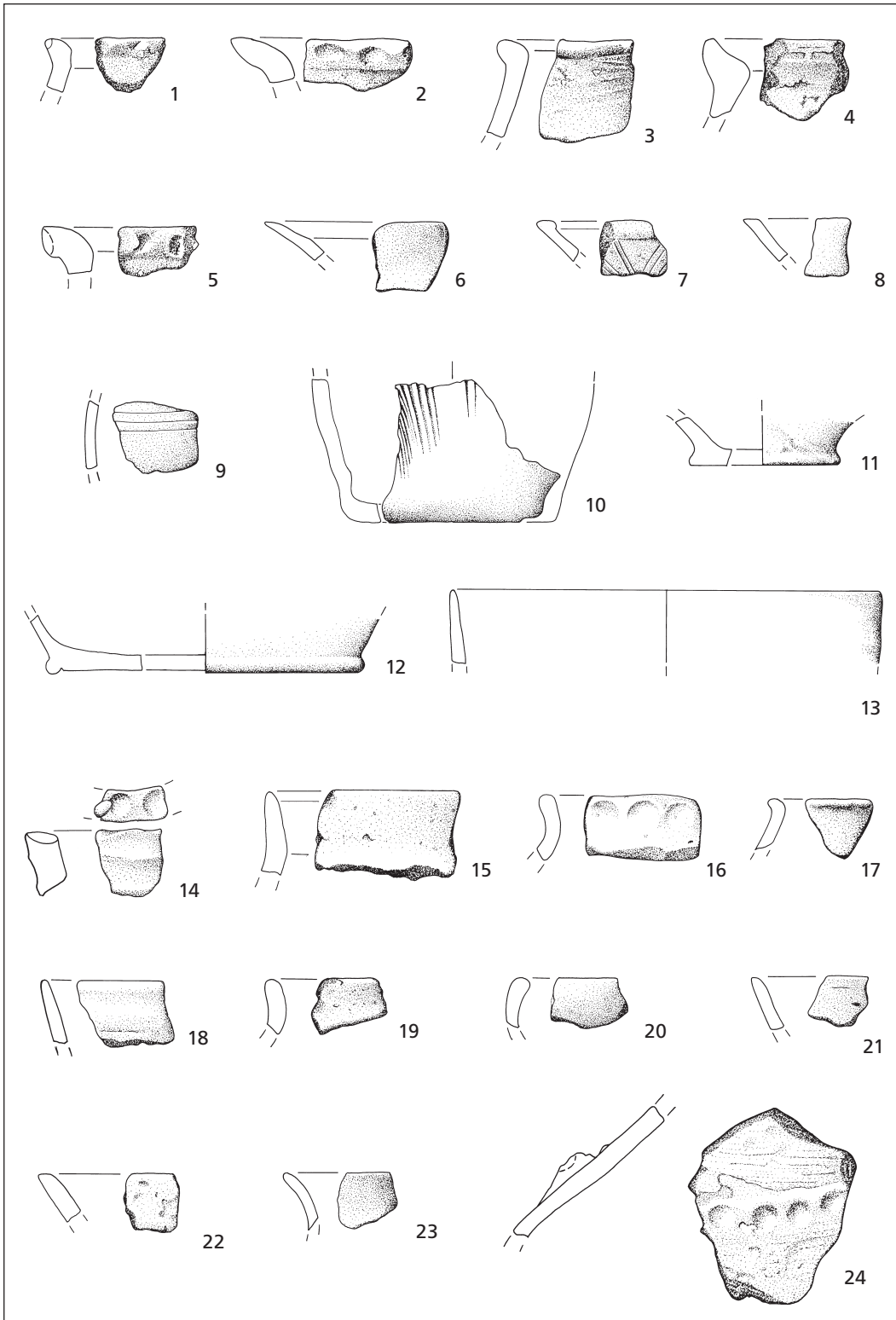

Sasbach (Lkr. Emmendingen). M 1:3.

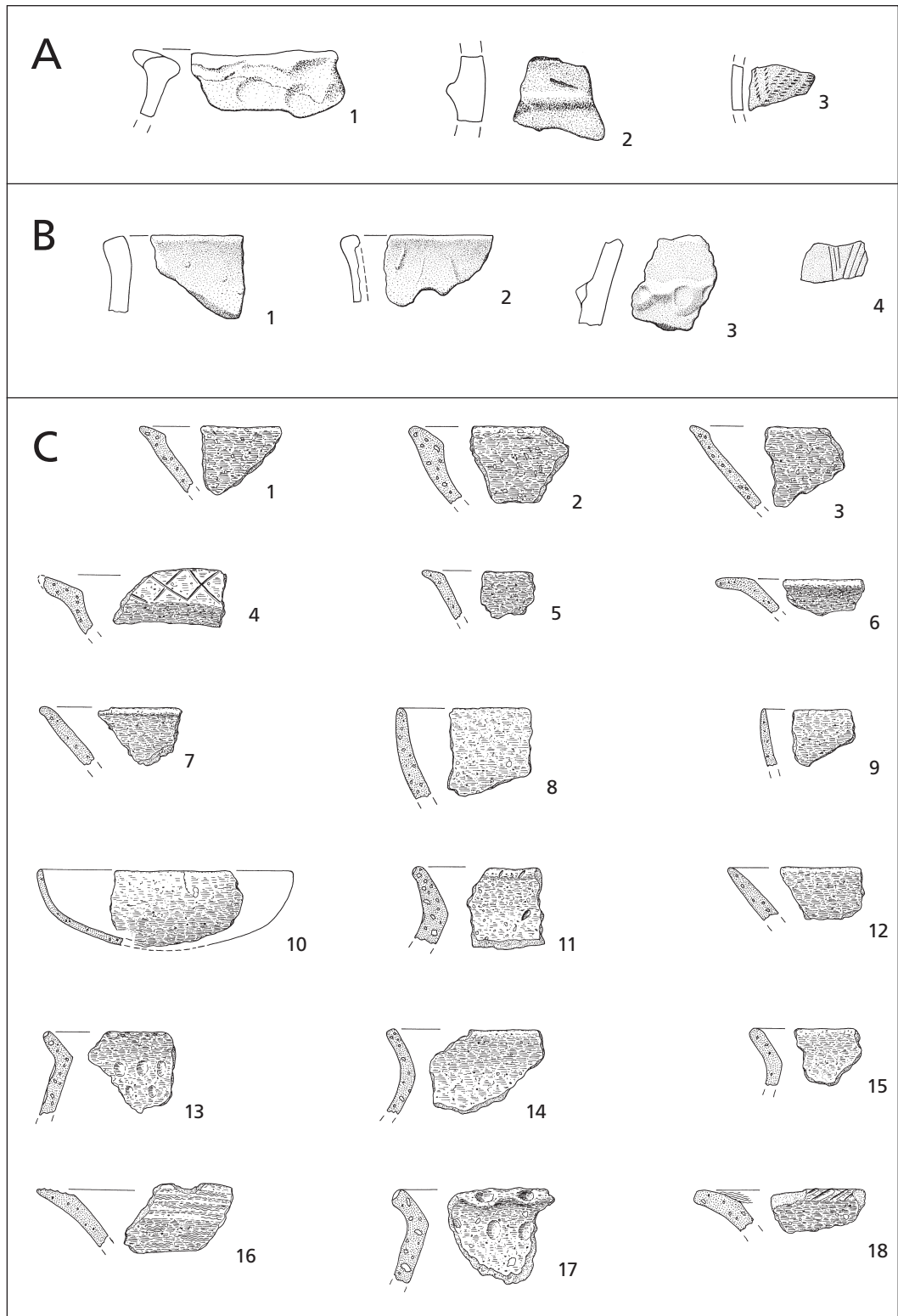

A Sasbach (Lkr. Emmendingen). M 1:3. – B Wutach E w a t t i n g e n (Lkr. Waldshut). M 1:3. –
 C Buchheim (Lkr. Tuttlingen). M 1:3.

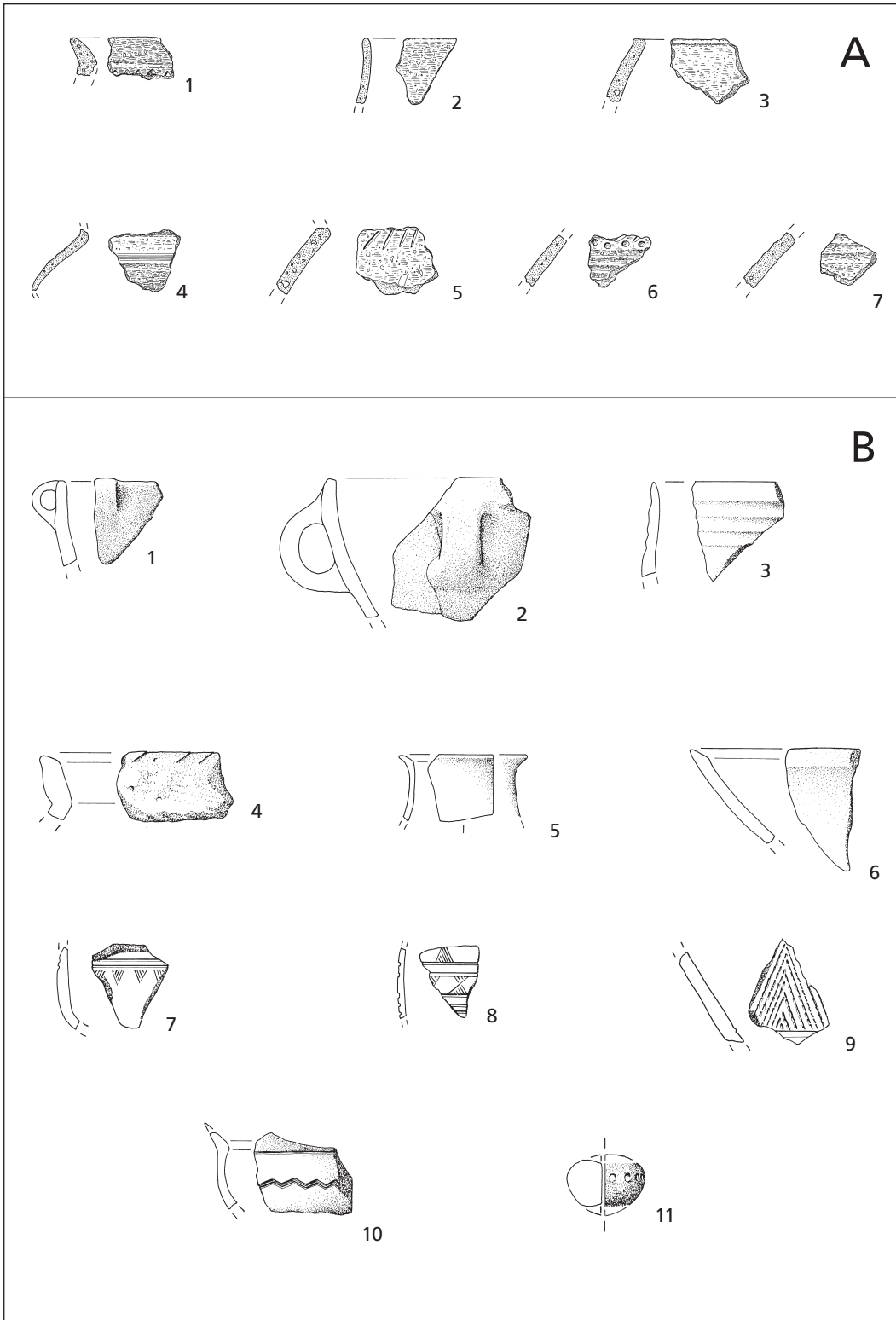

A Buchheim (Lkr. Tuttlingen). M 1:3. – B Efringen-Kirchen I s t e i n (Lkr. Lörrach). M 1:3.

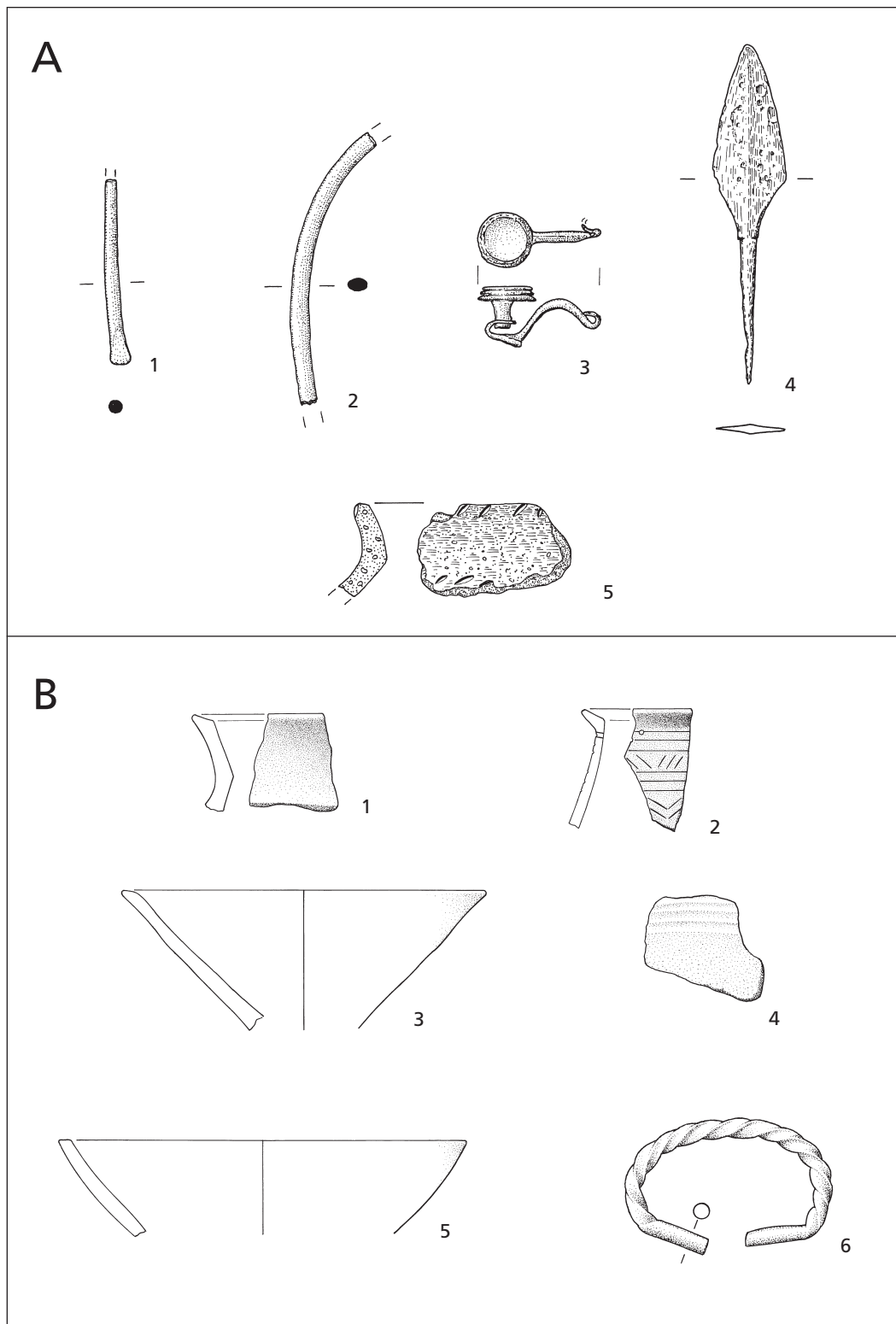

A Hausen am Tann (Zollernalbkreis). 1-4 Fdst. 1, 5 Fdst. 3. 1-3 M 2:3; 4 M 1:2; 5 M 1:3. –
 B Hohentengen am Hochrhein (Lkr. Waldshut). 6 M 1:2; sonst M 1:3.

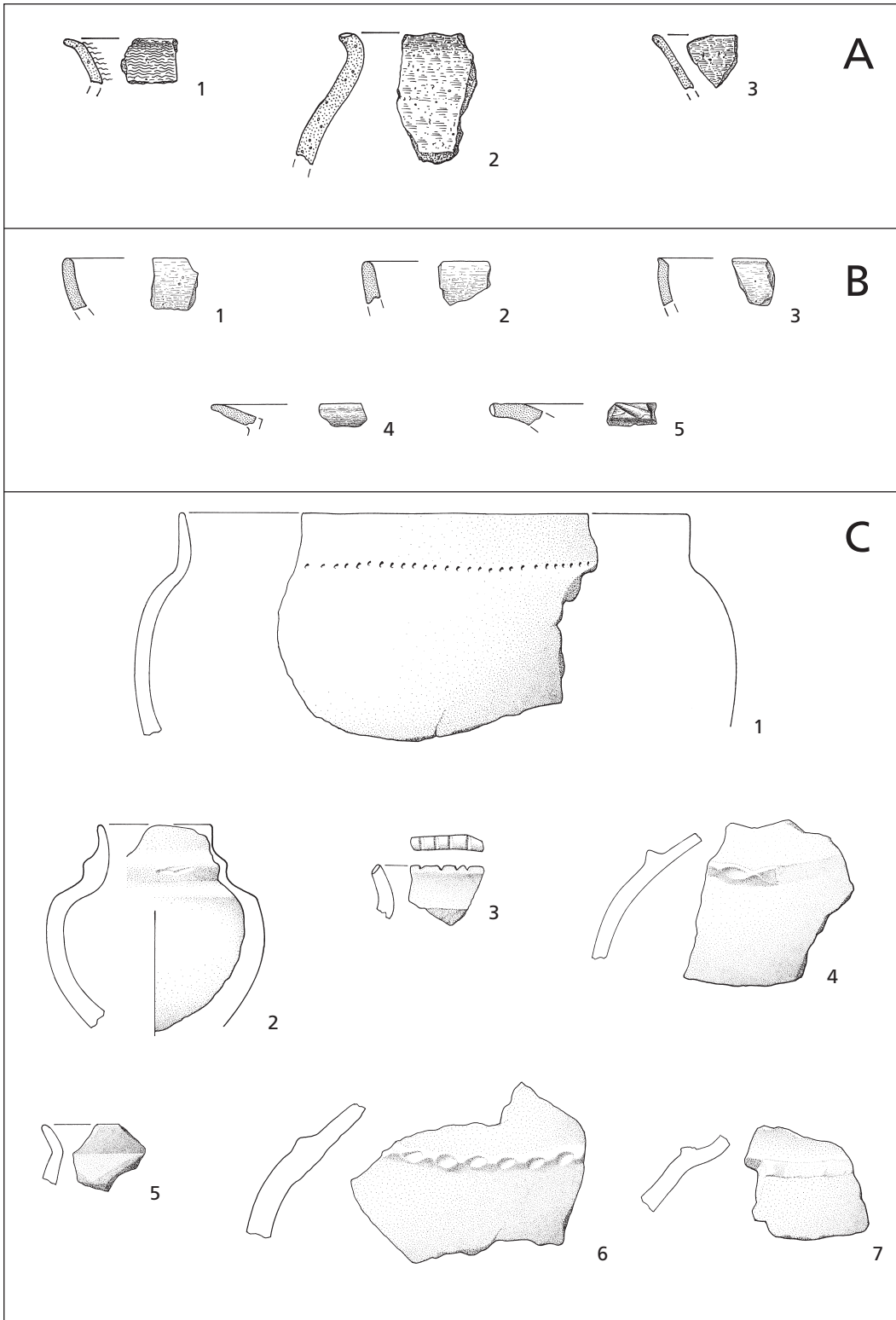

A Leibertingen Kreenheinstetten (Lkr. Sigmaringen). M 1:3. – B Burladingen Salmendingen (Zollernalbkreis). M 1:3. – C Eendingen (Lkr. Emmendingen). M 1:3.

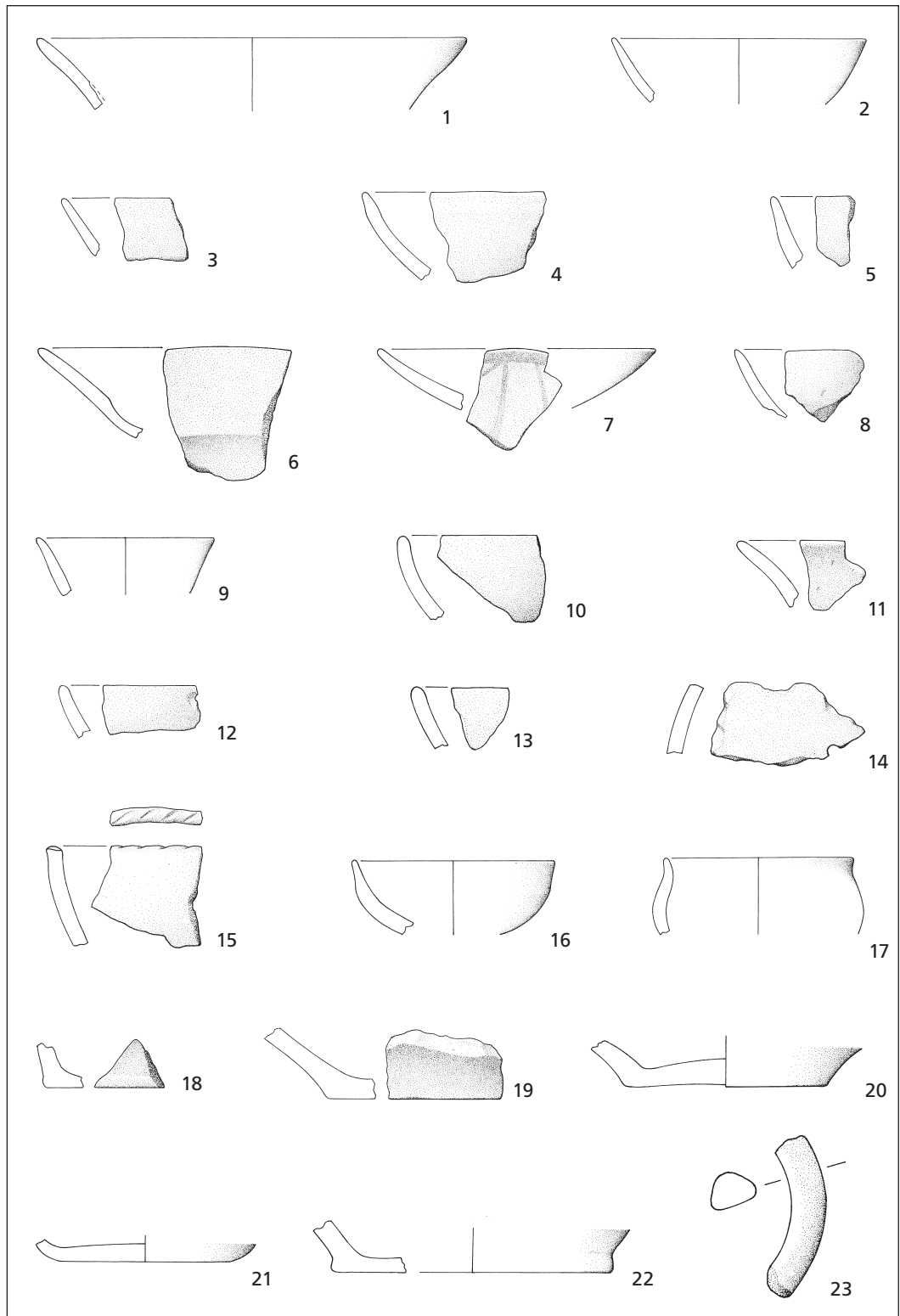

Endingen (Lkr. Emmendingen). 23 M 1:2; sonst M 1:3.

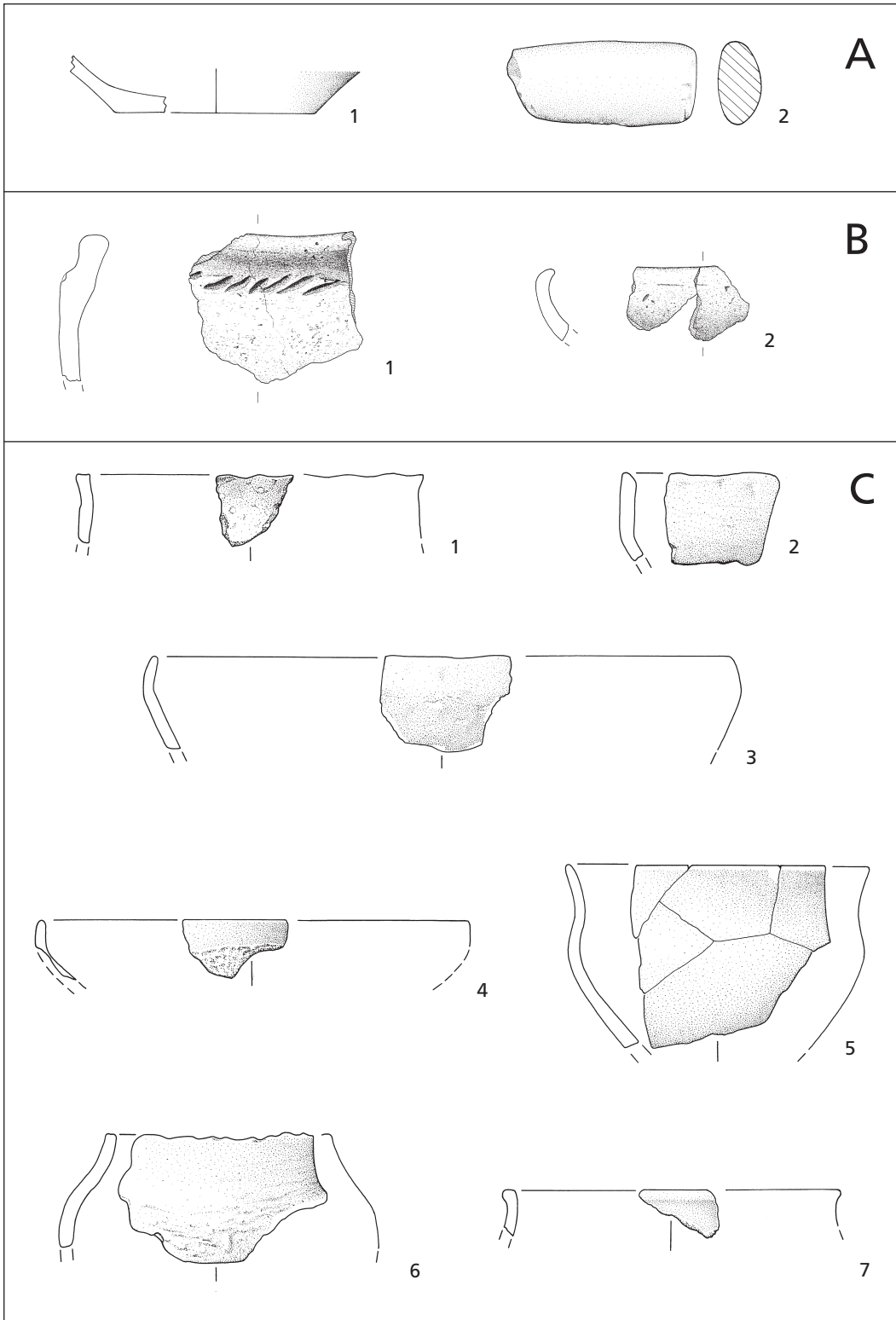

A Endingen (Lkr. Emmendingen). M 1:3. – B Esslingen S i r n a u (Lkr. Esslingen). M 1:3. – C Offenburg (Ortenaukreis). M 1:3.

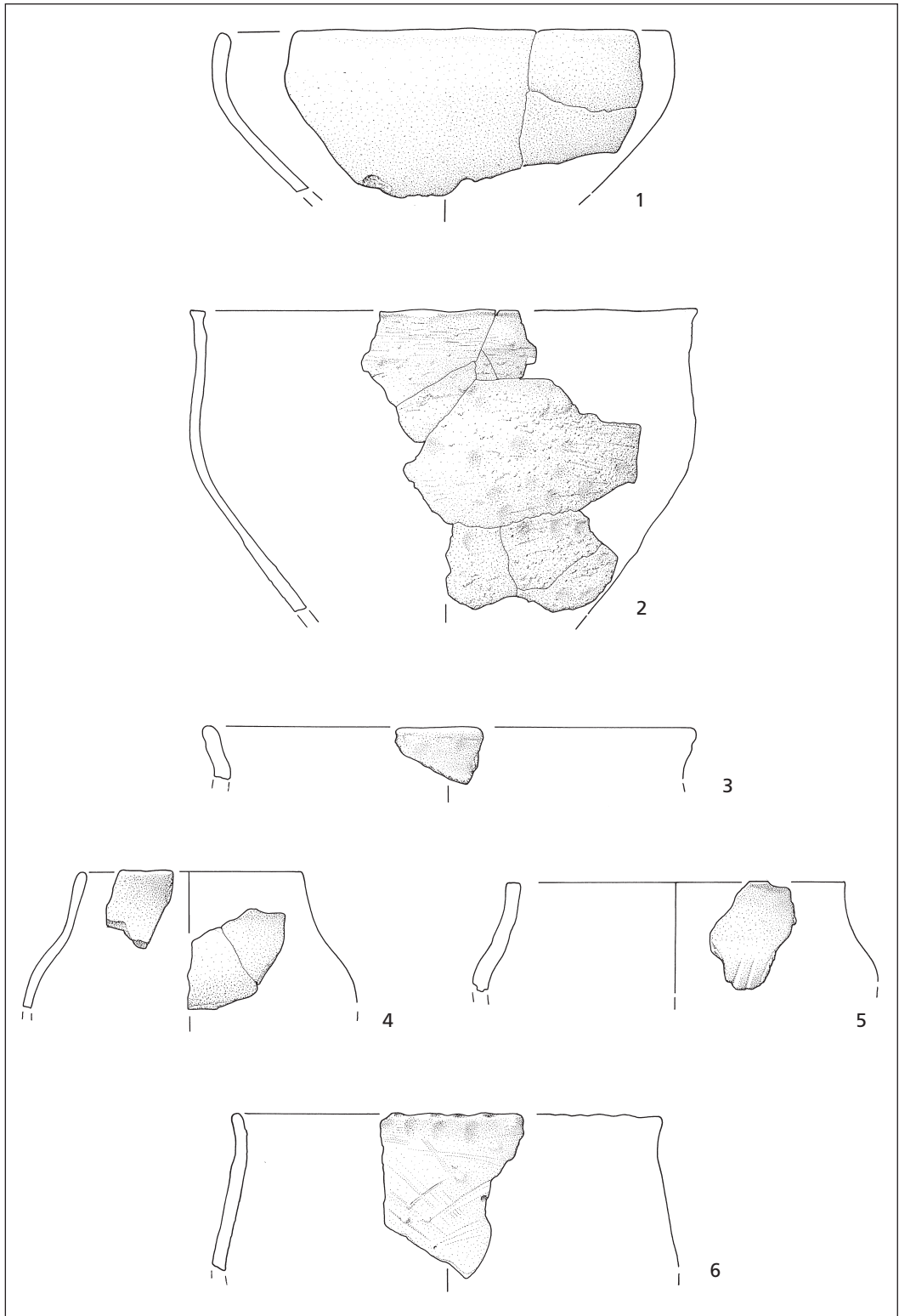

Offenburg (Ortenaukreis). M 1:3.

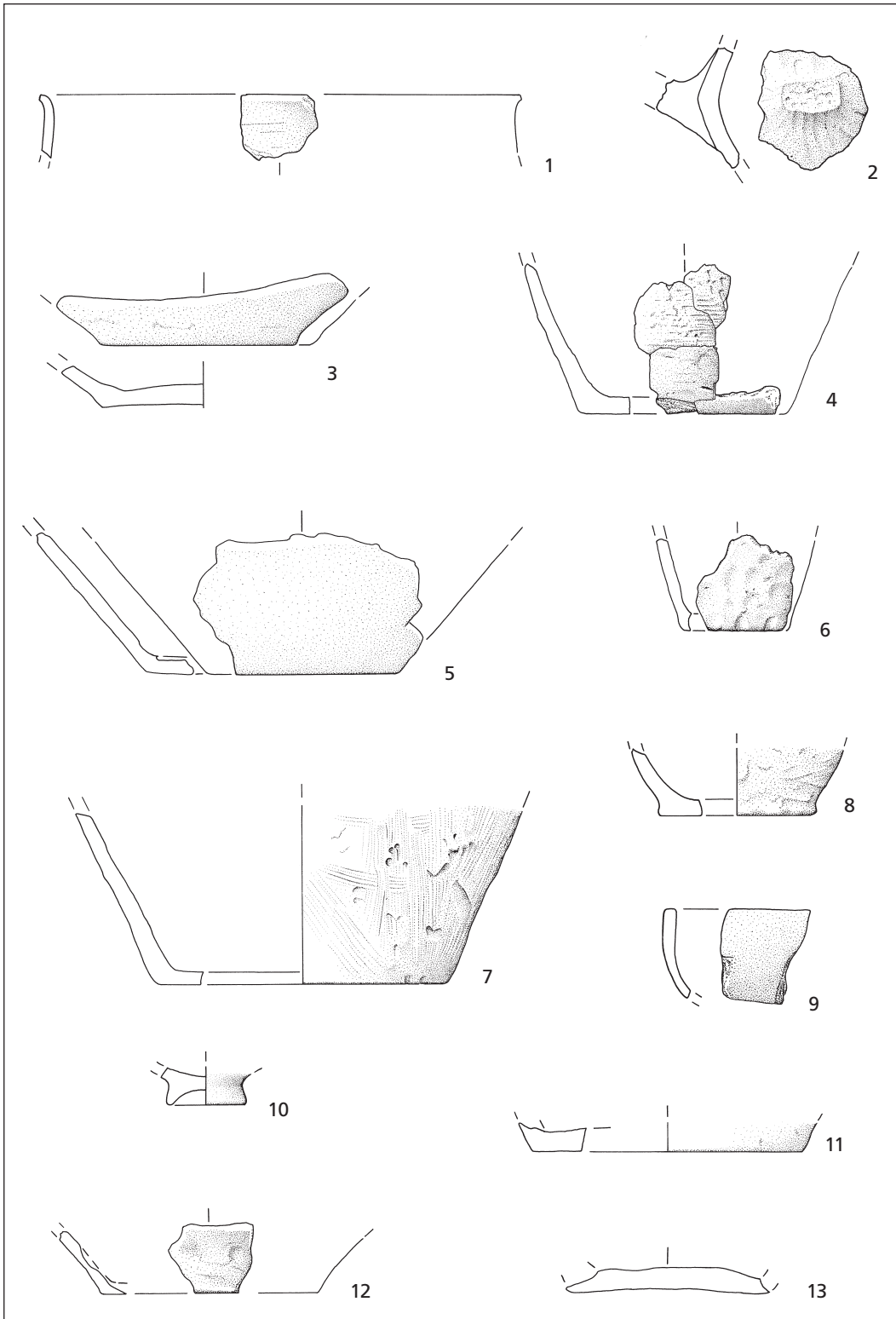

Offenburg (Ortenaukreis). M 1:3.

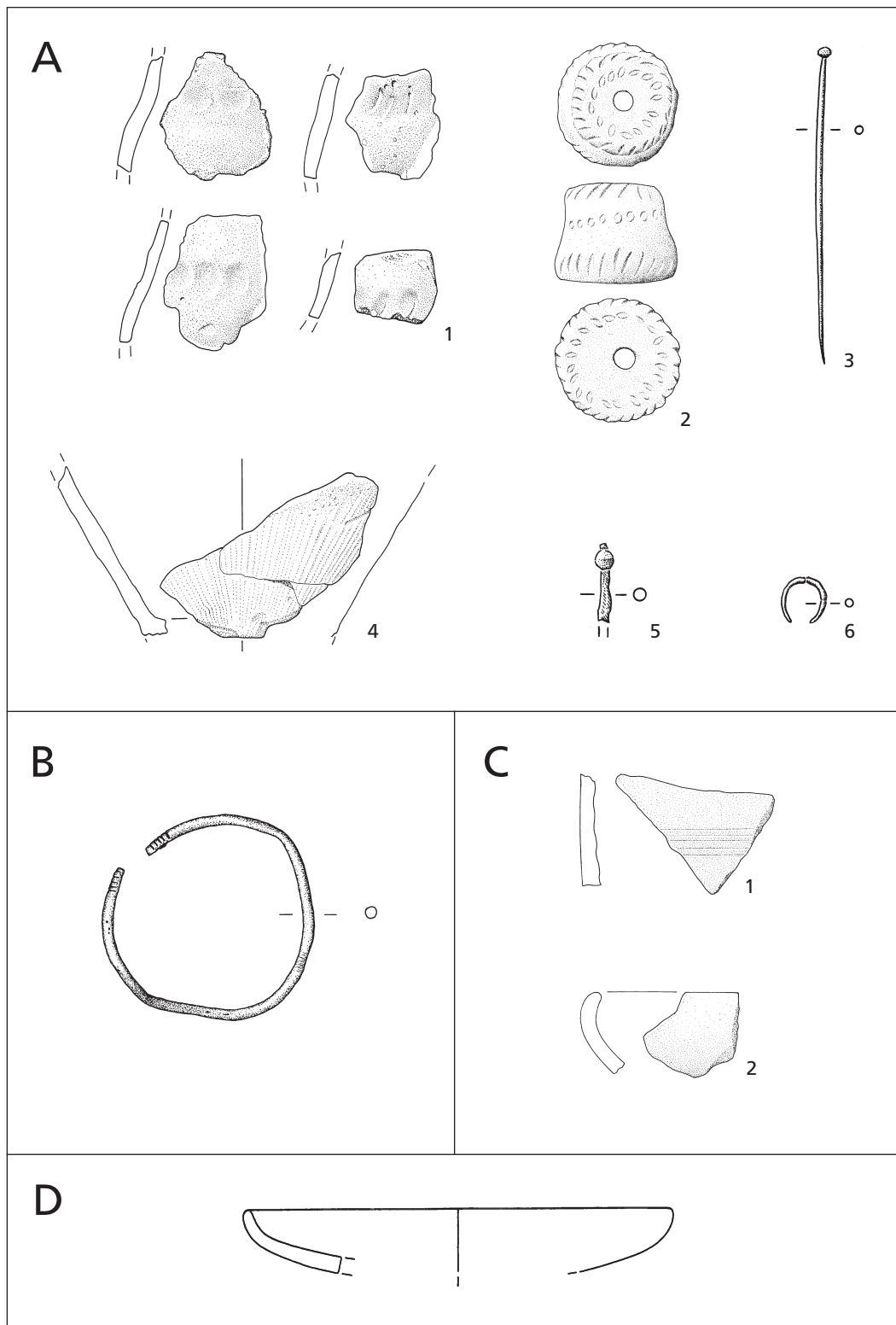

A Offenburg (Ortenaukreis). 1.2.4 M 1:3; sonst M 2:3. – B Tauberbischofsheim Distelhause n (Main-Tauber-Kreis). Fdst. 1. M 2:3. – C Tuningen (Schwarzwald-Baar-Kreis). M 1:3. – D Billigheim K a t z e n t a l (Neckar-Odenwald-Kreis). M 1:3.

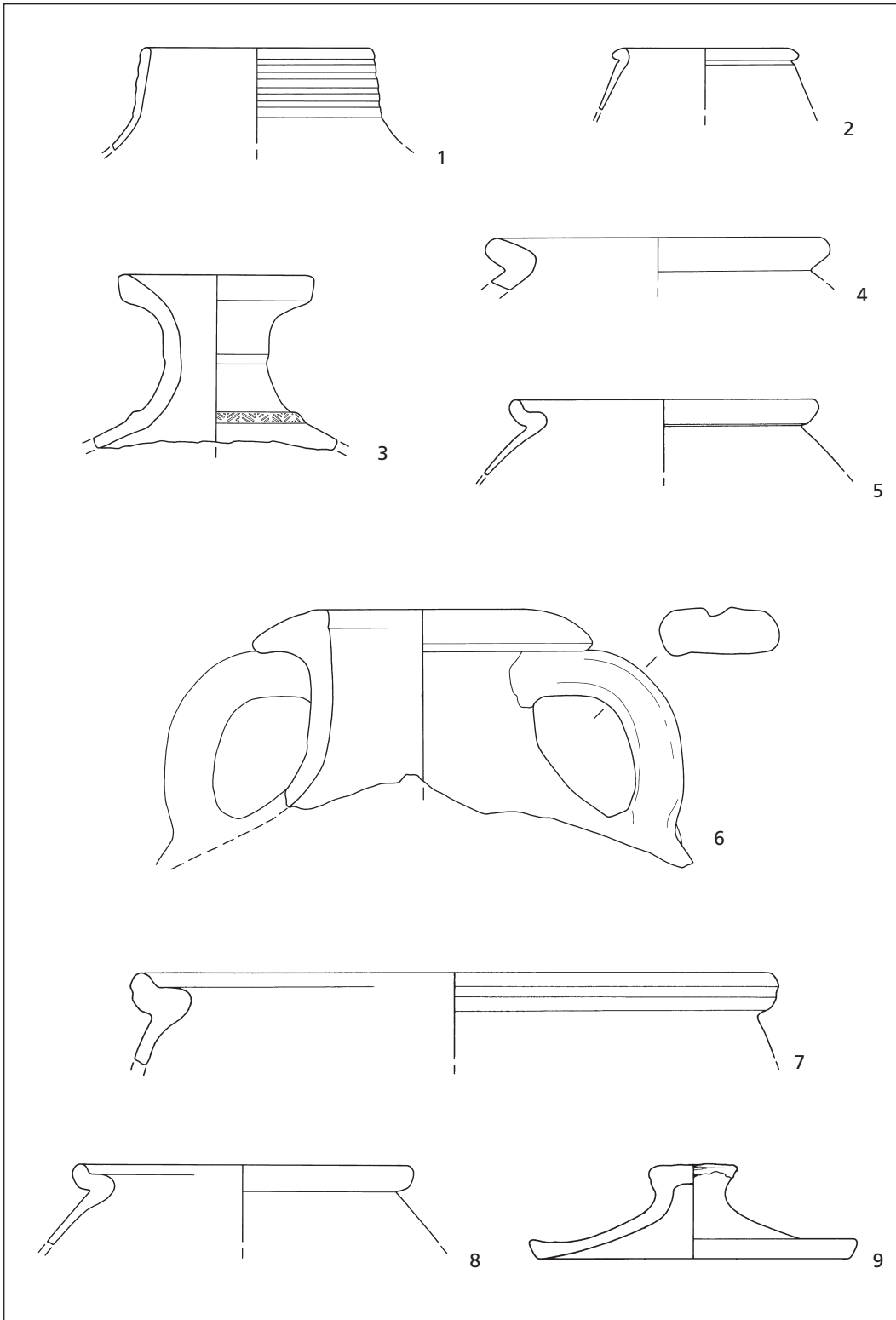

Billigheim Katzentäl (Neckar-Odenwald-Kreis). M 1:3.

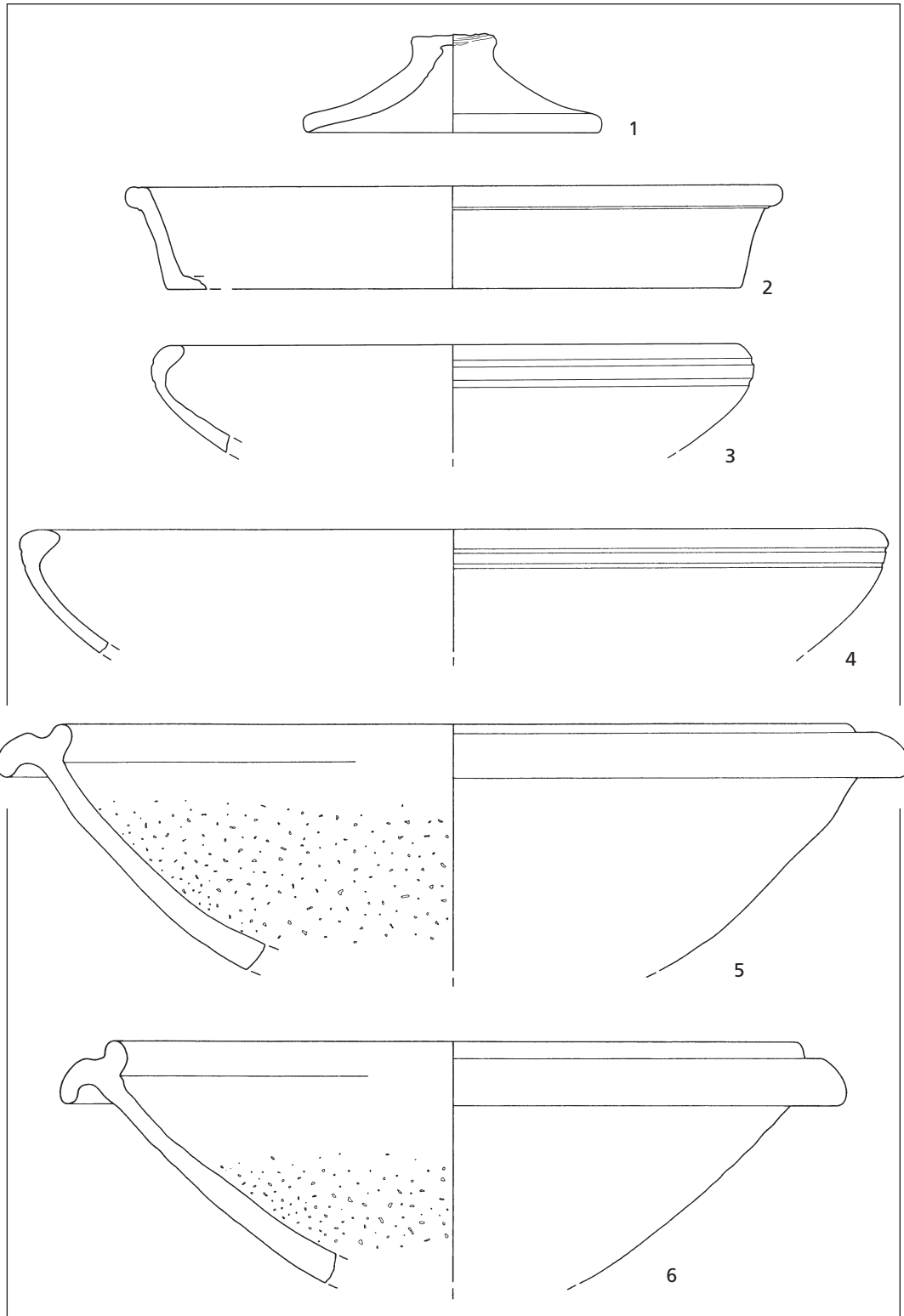

Billigheim Katzental (Neckar-Odenwald-Kreis). M 1:3.

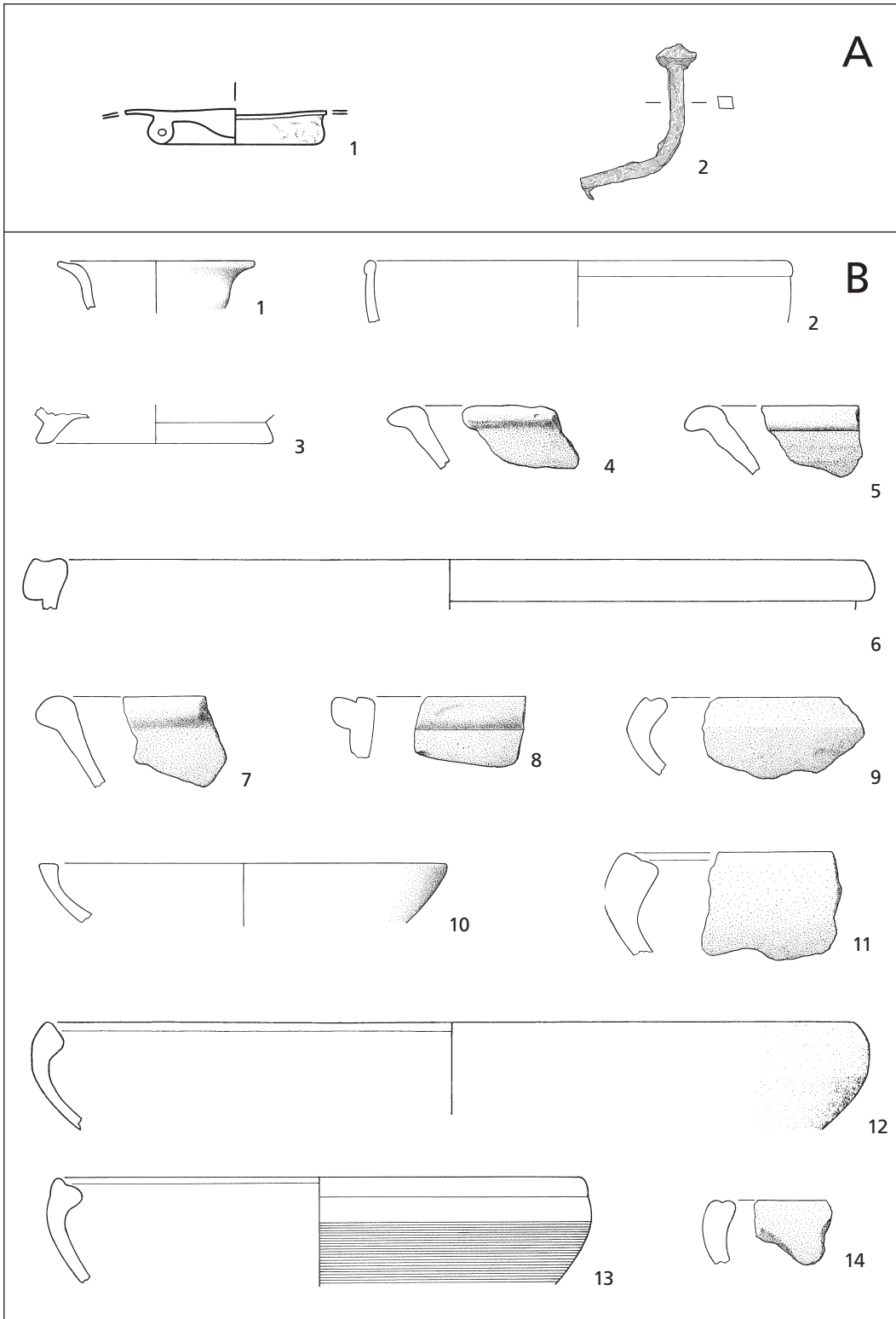

A Billigheim Katzental (Neckar-Odenwald-Kreis). M 1:3. – B Wolfach (Ortenaukreis). M 1:3.

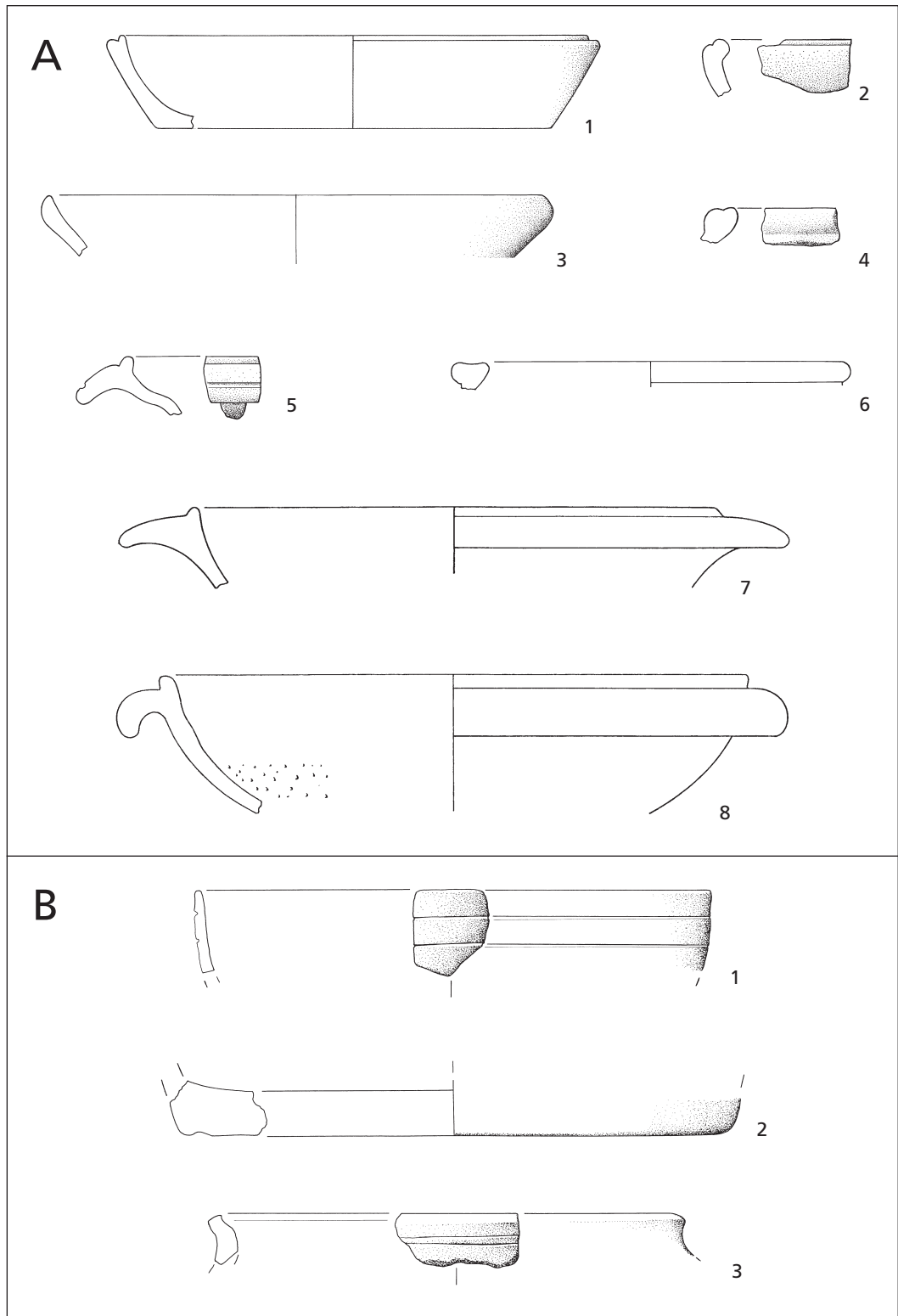

A Wolfach (Ortenaukreis). M 1:3. – B Bärenthal (Lkr. Tuttlingen). M 1:3.

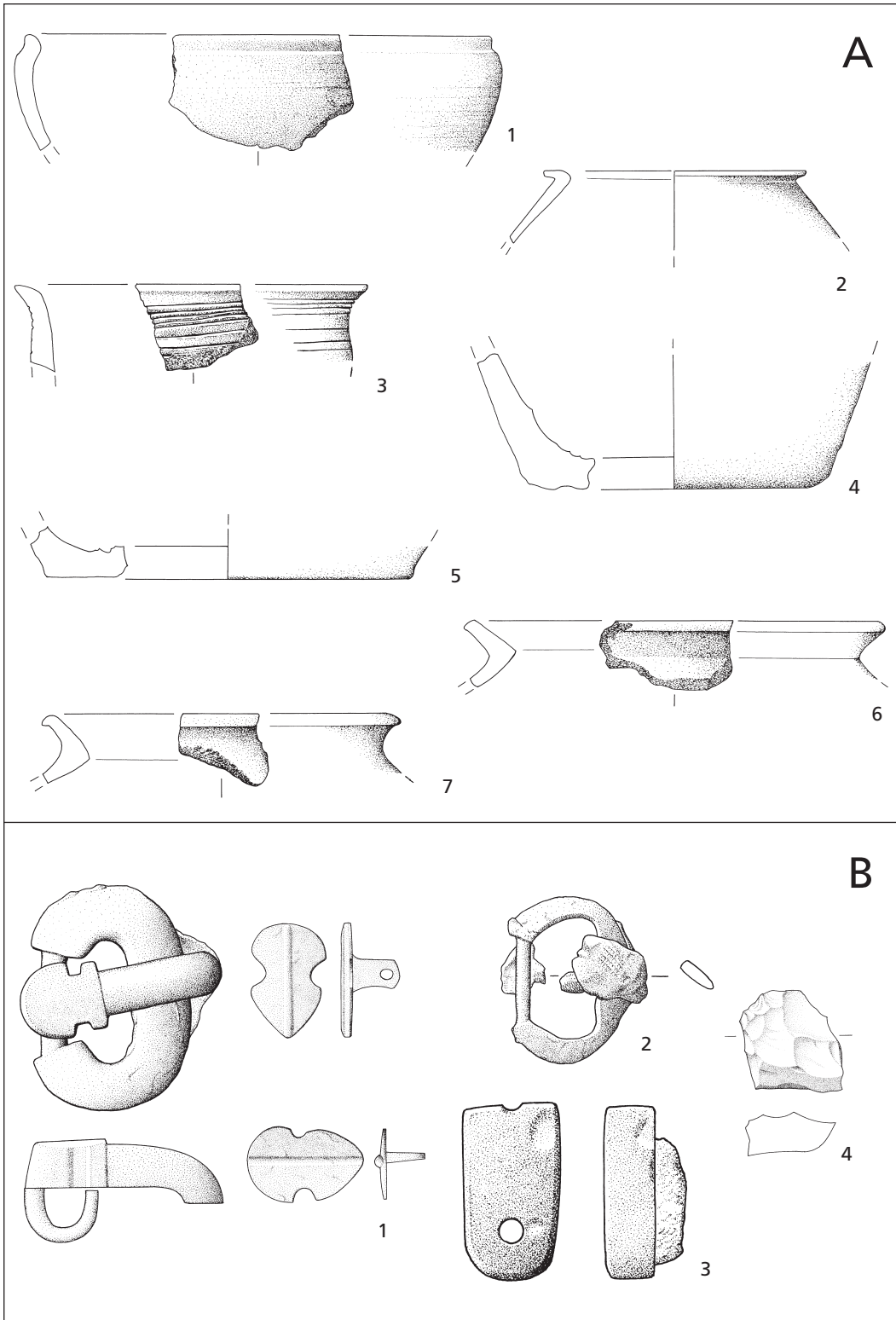

A Bärenthal (Lkr. Tuttlingen). M 1:3. – B Tuttlingen N e n d i n g e n (Lkr. Tuttlingen). M 2:3.

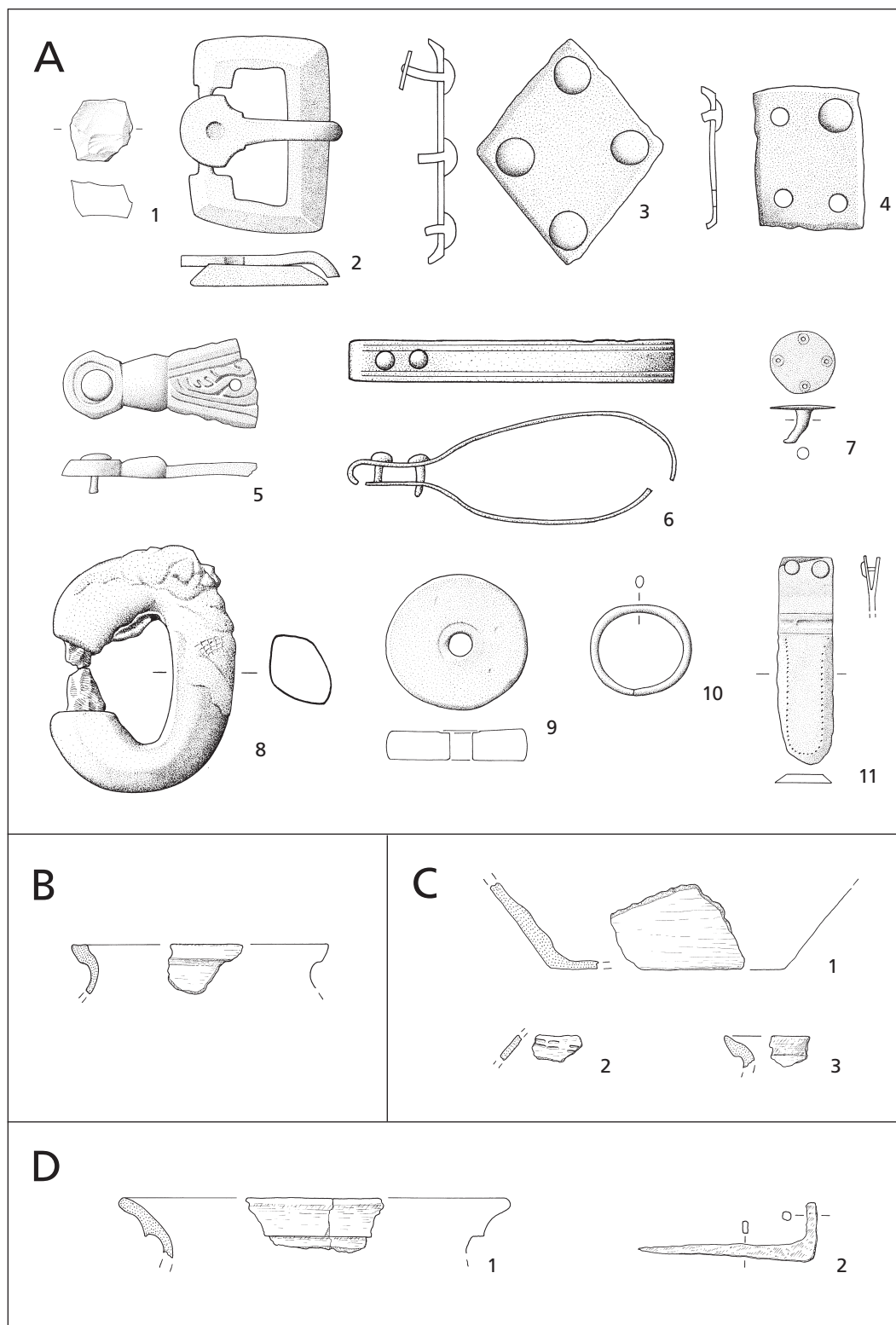

A Tuttlingen N e n d i n g e n (Lkr. Tuttlingen). M 2:3. – B Berg (Lkr. Ravensburg). M 1:3. – C Berghülen (Alb-Donau-Kreis). M 1:3. – D Blaustein H e r r l i n g e n / W e i d a c h (Alb-Donau-Kreis). M 1:3.

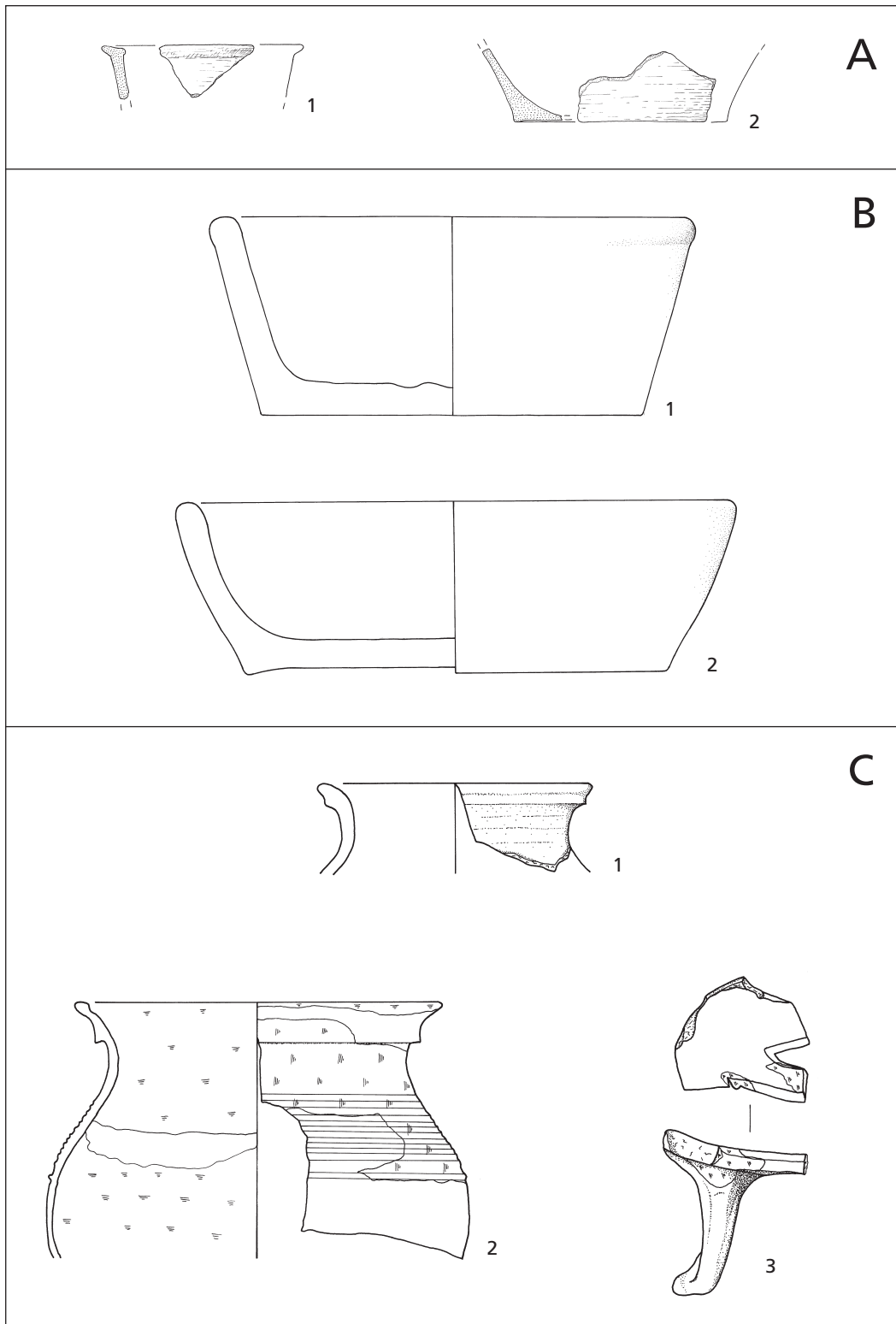

A Deggenhausertal D e g g e n h a u s e n (Bodenseekreis). M 1:3. – B Denzlingen (Lkr. Emmendingen). M 1:3. – C Eichstetten (Landkreis Breisgau-Hochschwarzwald). 1 Fdst. 1, 2,3 Fdst. 2. M 1:3.

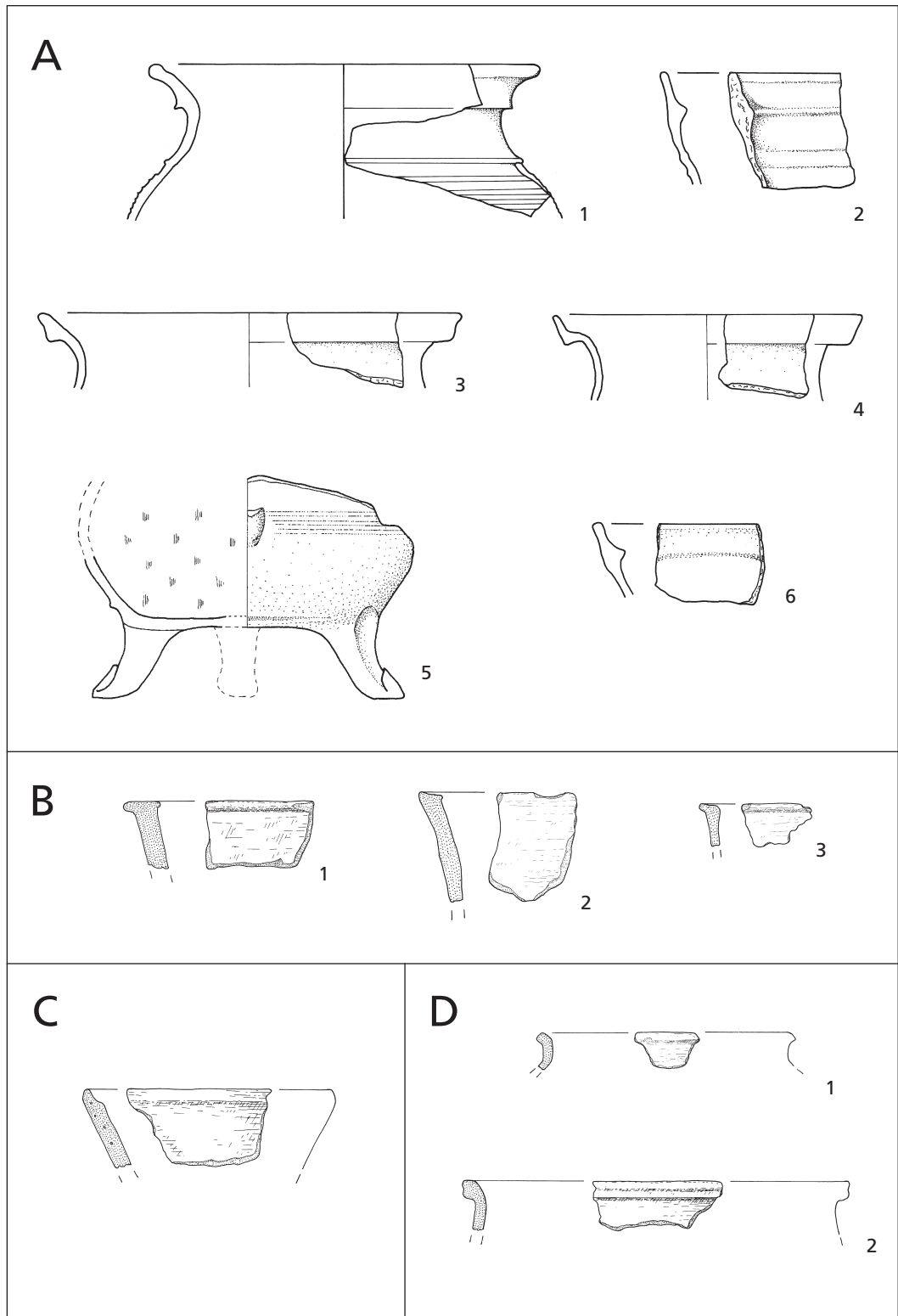

A Eichstetten (Landkreis Breisgau-Hochschwarzwald). Fdst. 2. M 1:3. – B Frickingen (Bodenseekreis). M 1:3. – C Heiligenberg Hattenweiler/Katzensteig Bodenseekreis). M 1:3. – D Horgenzell Hasenweiler-Pfärrenbach (Lkr. Ravensburg). M 1:3.

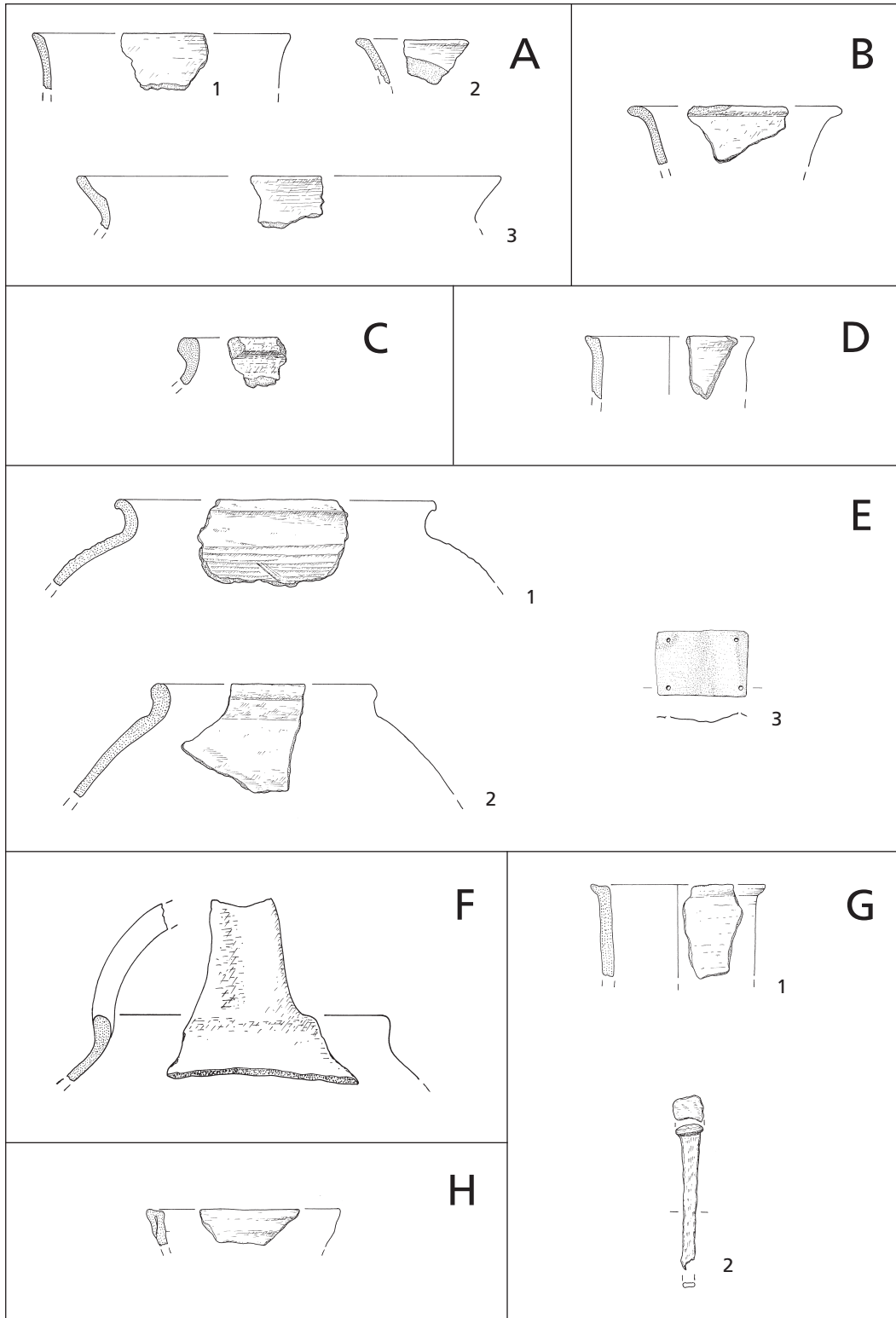

A Illmensee Lichtenegg (Lkr. Sigmaringen). Fdst. 1. M 1:3. – B Kießlegg Zaisenhofen (Lkr. Ravensburg). M 1:3. – C Markdorf (Bodenseekreis). M 1:3. – D Ostrach Burgweiler (Lkr. Sigmaringen). M 1:3. – E Owingen Hohenedmann (Bodenseekreis). M 1:3. – F Ravensburg (Lkr. Ravensburg). M 1:3. – G Starzach Fellendorf (Lkr. Tübingen). M 1:3. – H Überlingen (Bodenseekreis). M 1:3.