

Tafel 1 bis 133

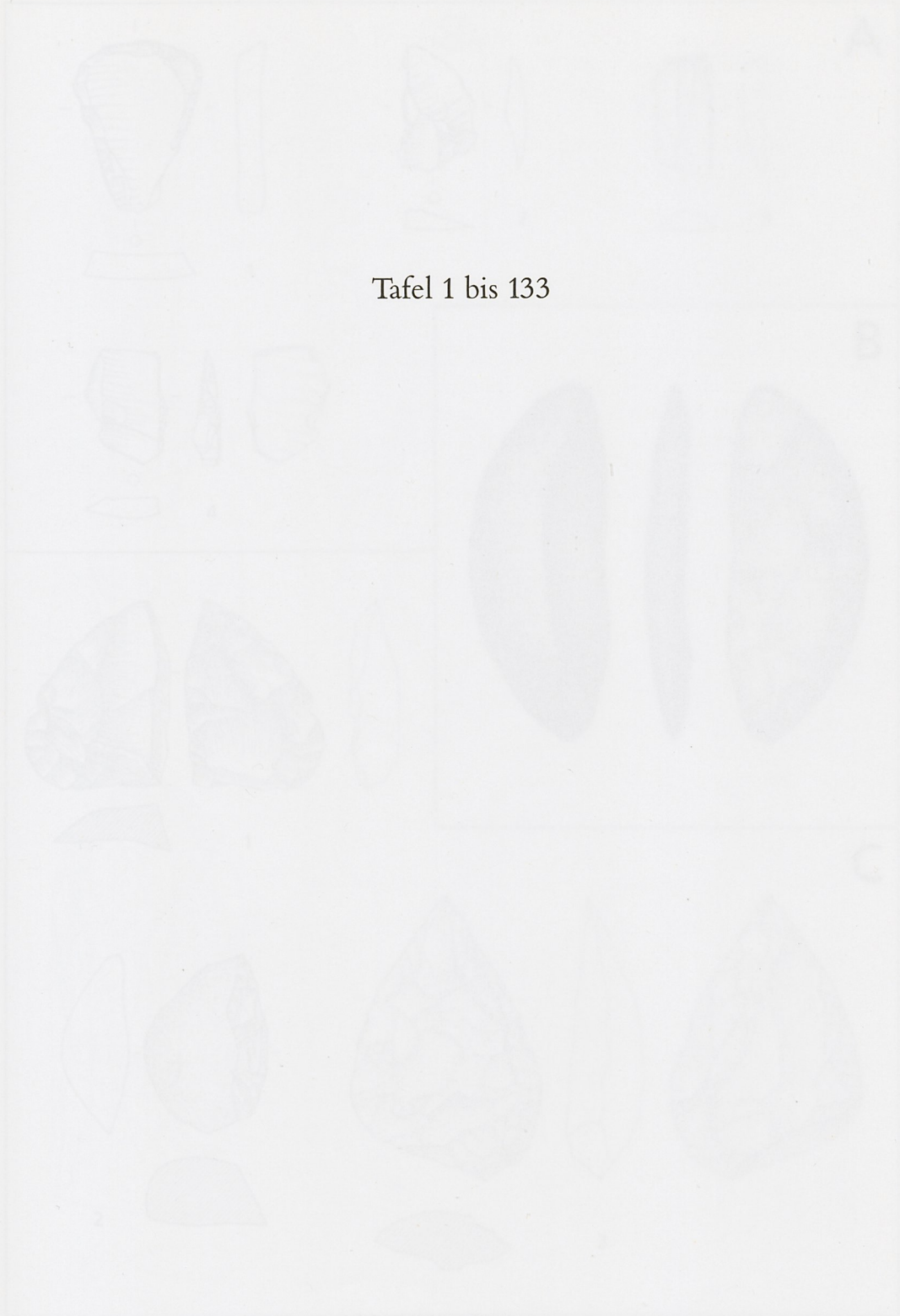

A Neuloh-Bodinger Dufourberg (Lkr Ludwigsburg) M 1. 1-3 (Kl. Stein-
 Fund) M 1. 1. - C Ilberischen Eisensteinen (Kl. Bogen-
 Fund) M 1. 1.

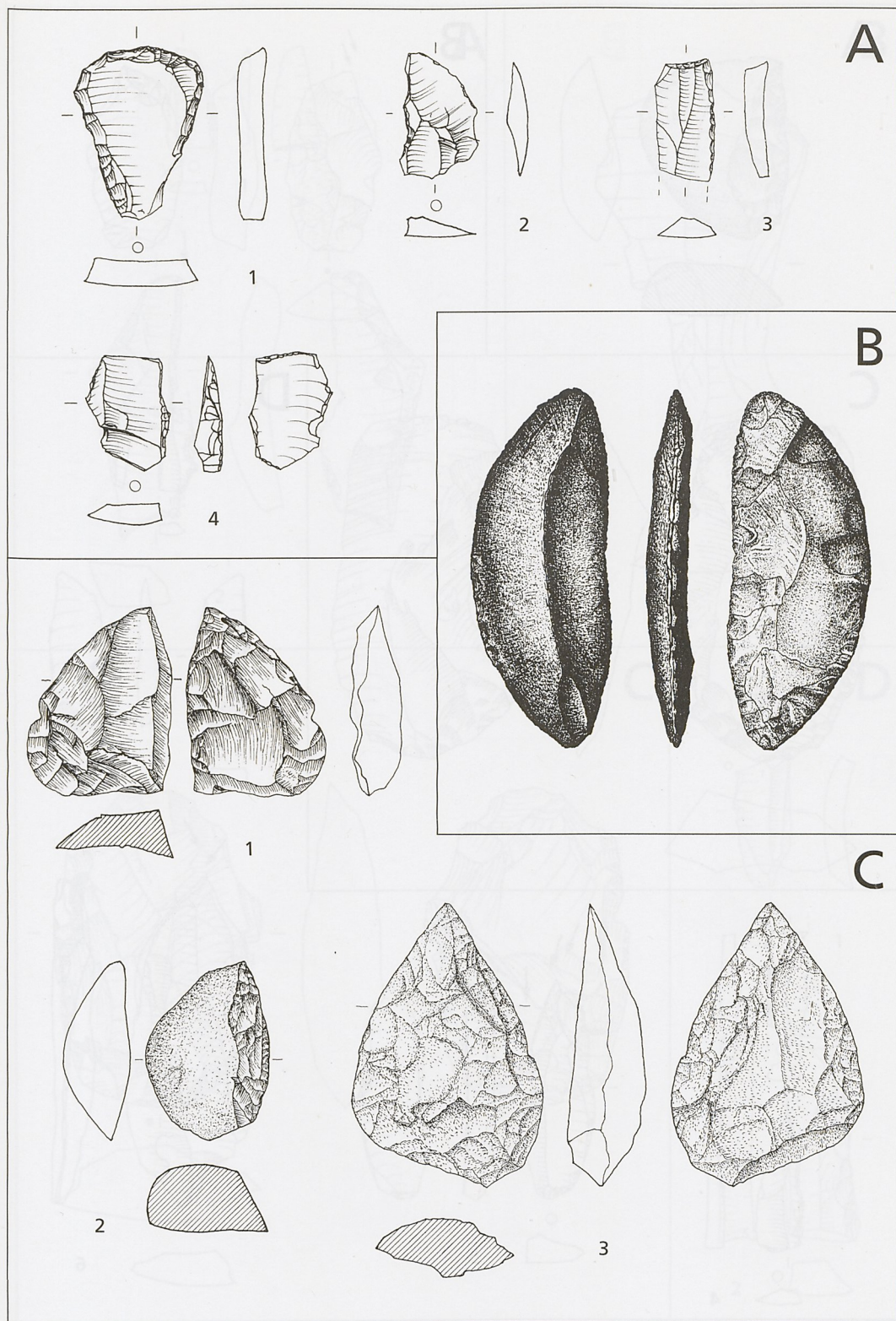

A Bietigheim-Bissingen Unterberg (Lkr. Ludwigsburg). M 1 : 1. – B Brühl (Rhein-Neckar-Kreis). M 1 : 3. – C Ehrenkirchen Ehrenstetten (Kr. Breisgau-Hochschwarzwald). M 1 : 2.

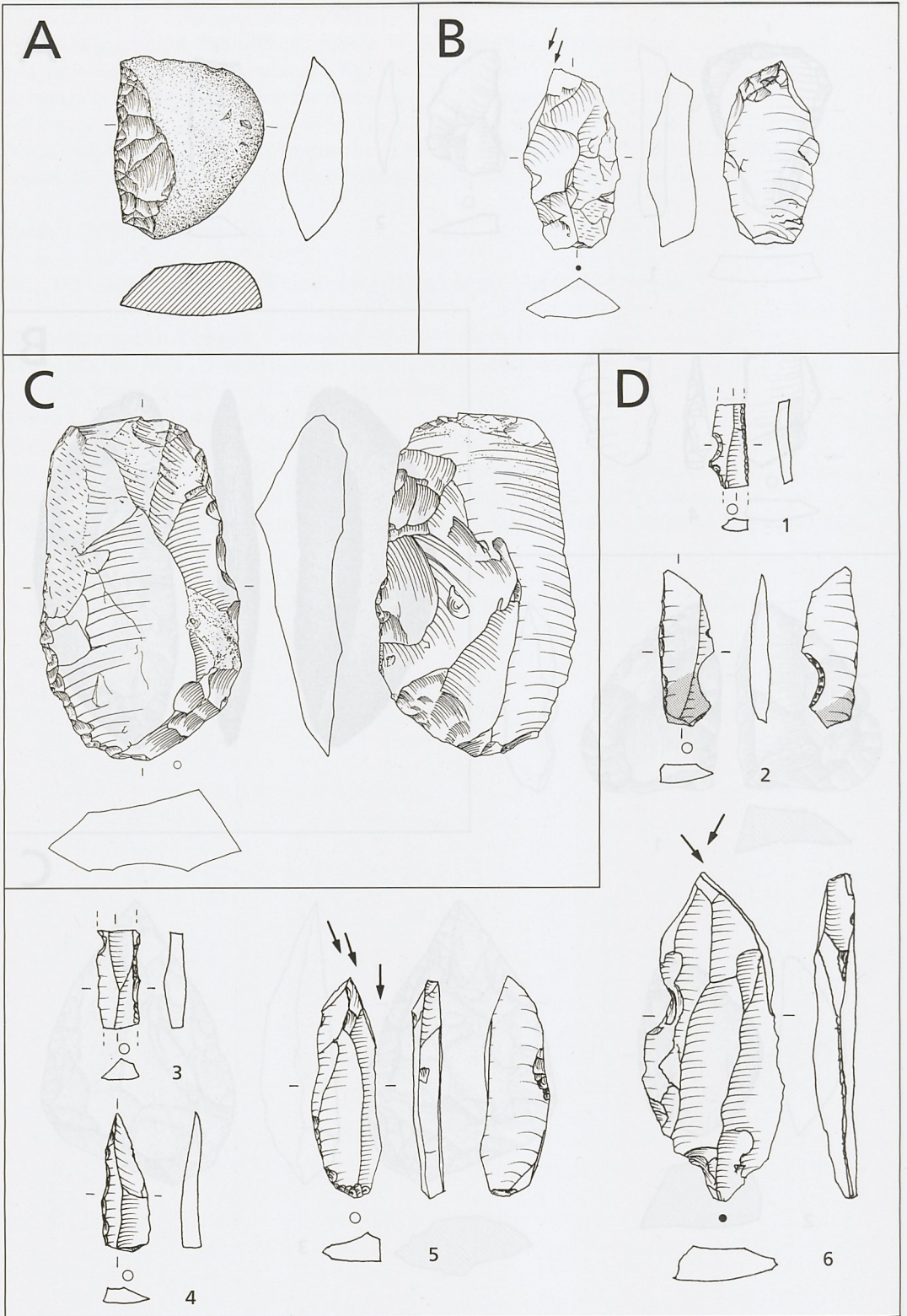

A Ehrenkirchen Ehrenstetten (Kr. Breisgau-Hochschwarzwald). M 1 : 2. – B Gemmrigheim (Lkr. Ludwigsburg). M 2 : 3. – C Gschwend Altersberg (Ostalbkreis). M 1 : 2. – D Heubach (Ostalbkreis). M 1 : 1.

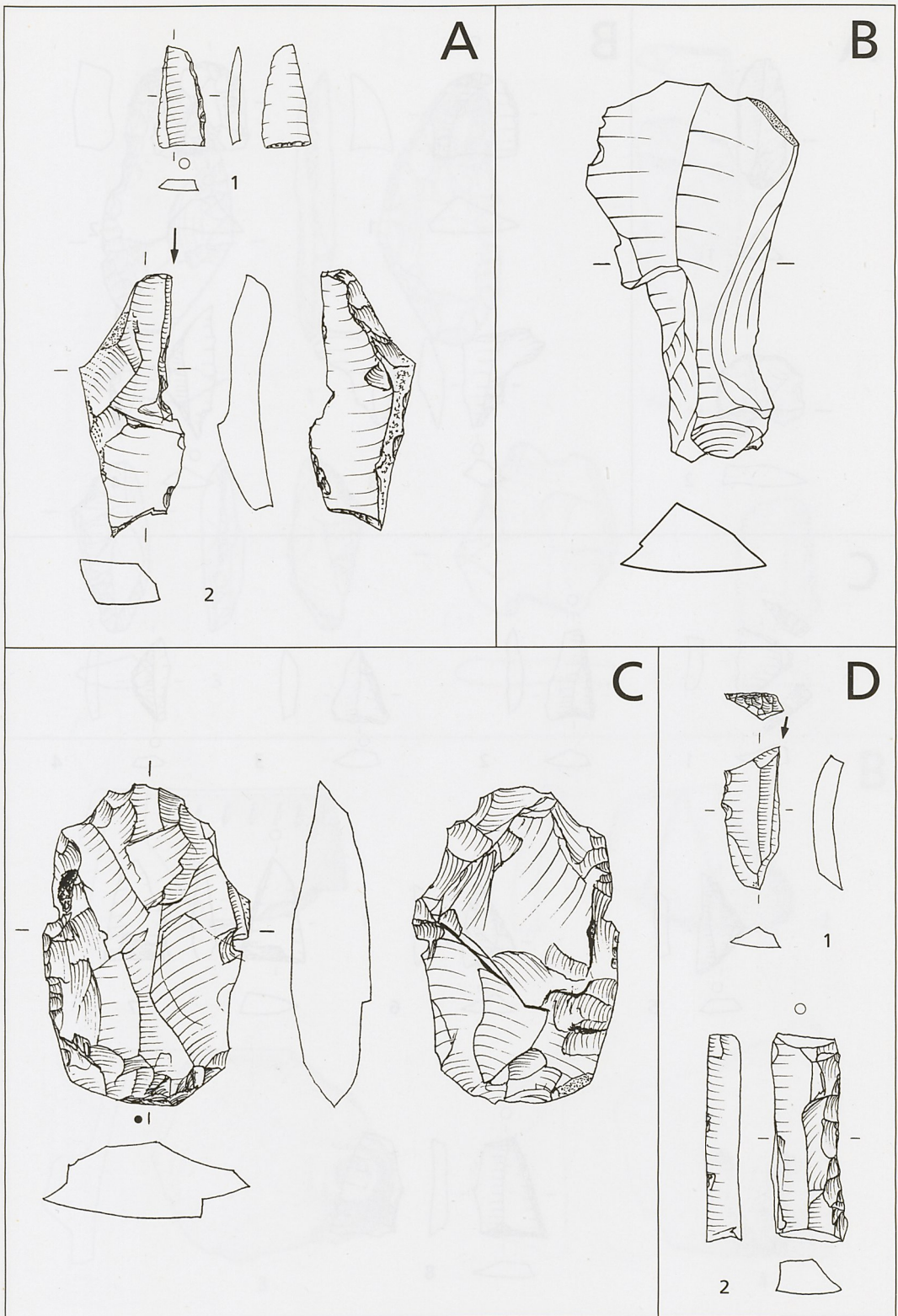

A Limbach Scherlingen (Neckar-Odenwald-Kreis). M 1:1. – B Marbach am Neckar (Lkr. Ludwigsburg). M 1:1. – C Reutlingen Gönningen (Lkr. Reutlingen). M 1:1. – D Tiefenbronn Mühlhausen (Enzkreis). M 1:1.

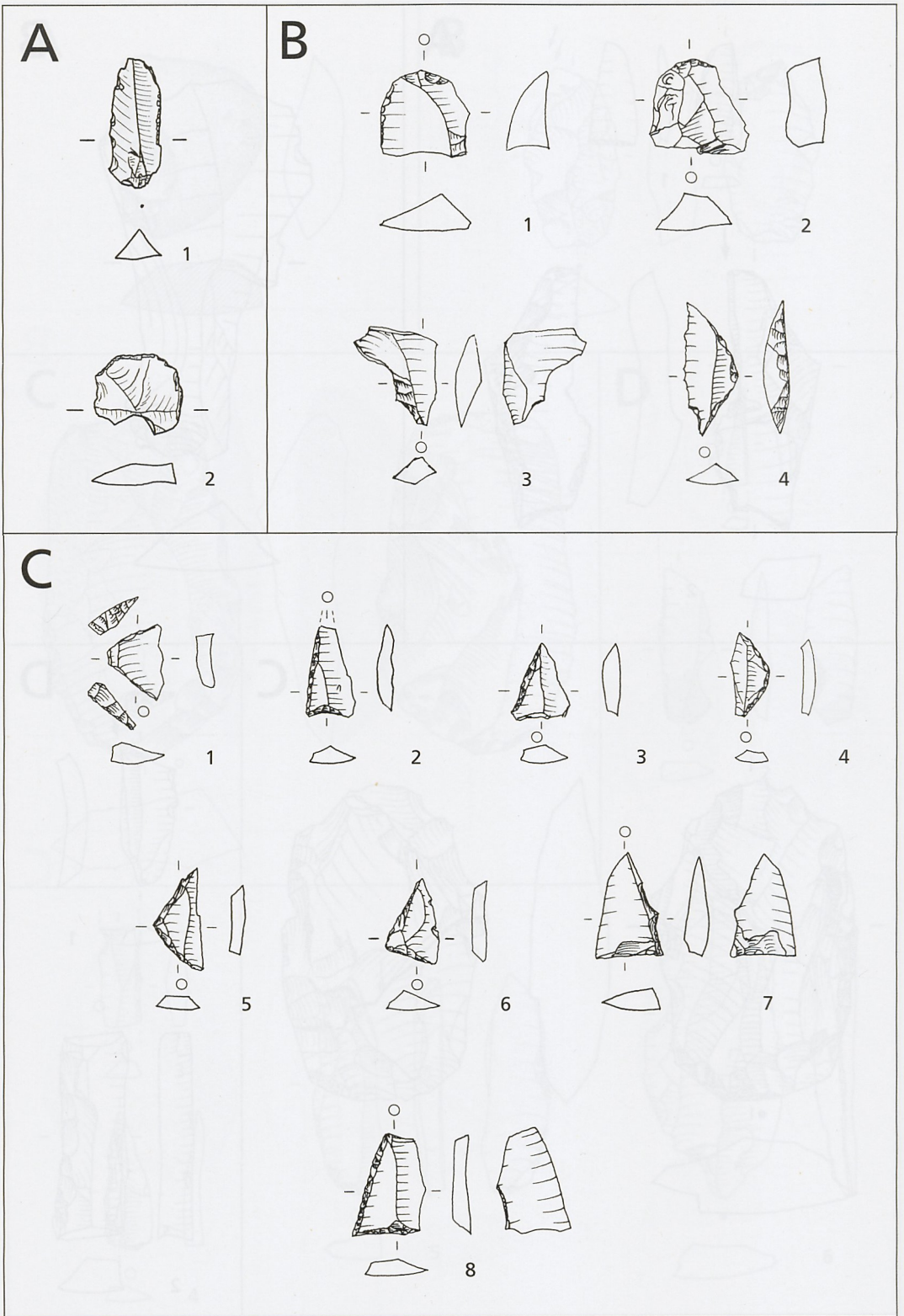

A Binau (Neckar-Odenwald-Kreis) M 1 : 1. – B Bühl Oberbruch (Lkr. Rastatt).
 Fdst. 4. M 1 : 1. – C Heubach (Ostalbkreis). M 1 : 1.

A

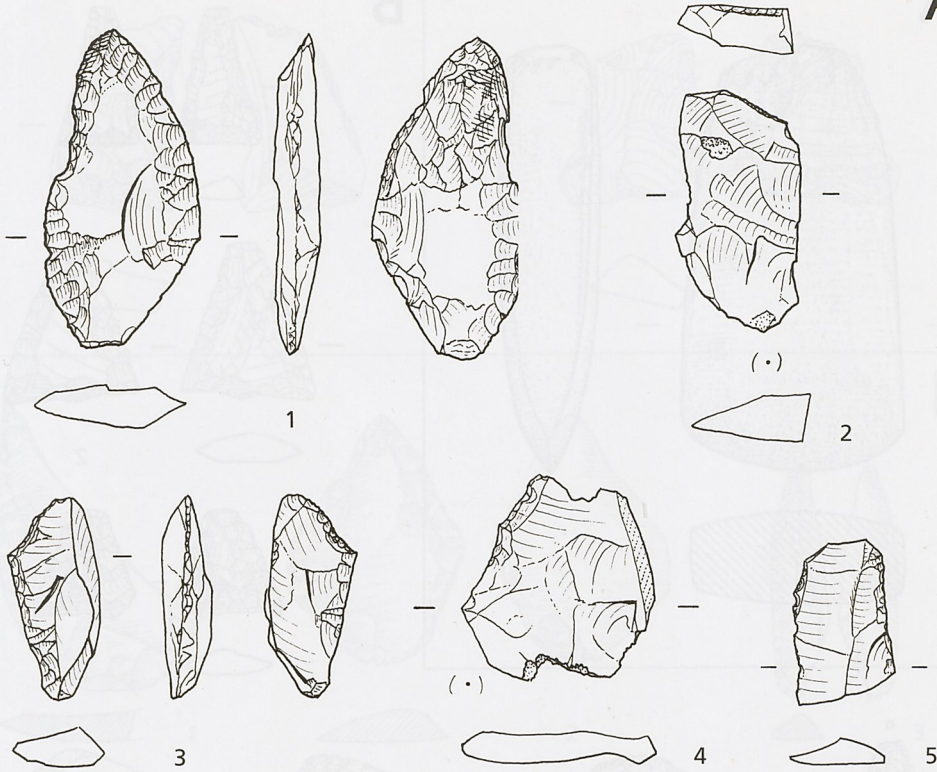

B

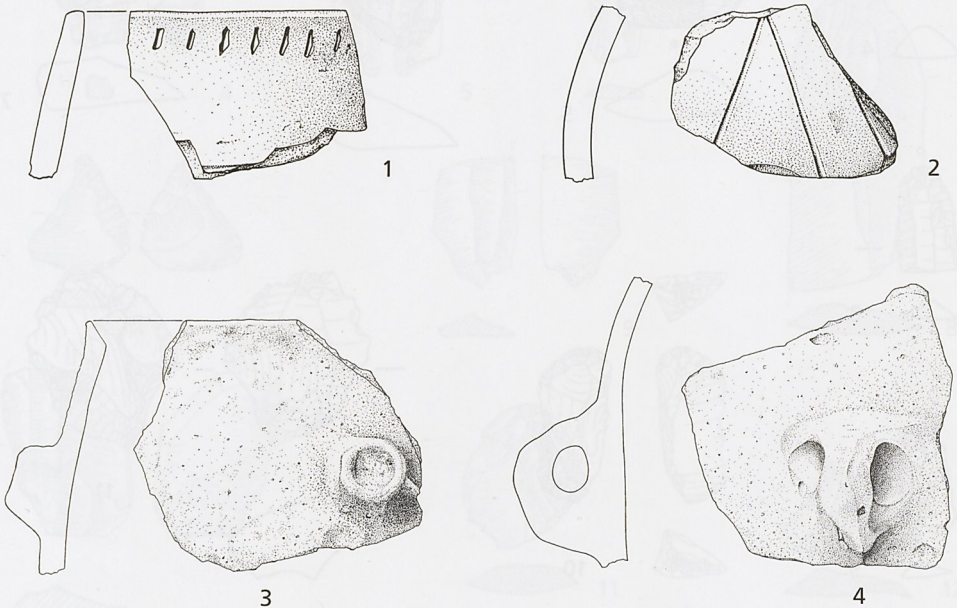

A Binau (Neckar-Odenwald-Kreis) M 1 : 1. – B Ditzingen Schöckingen
(Lkr. Ludwigsburg). 1.2 M 2 : 3; 3.4 M 1 : 3.

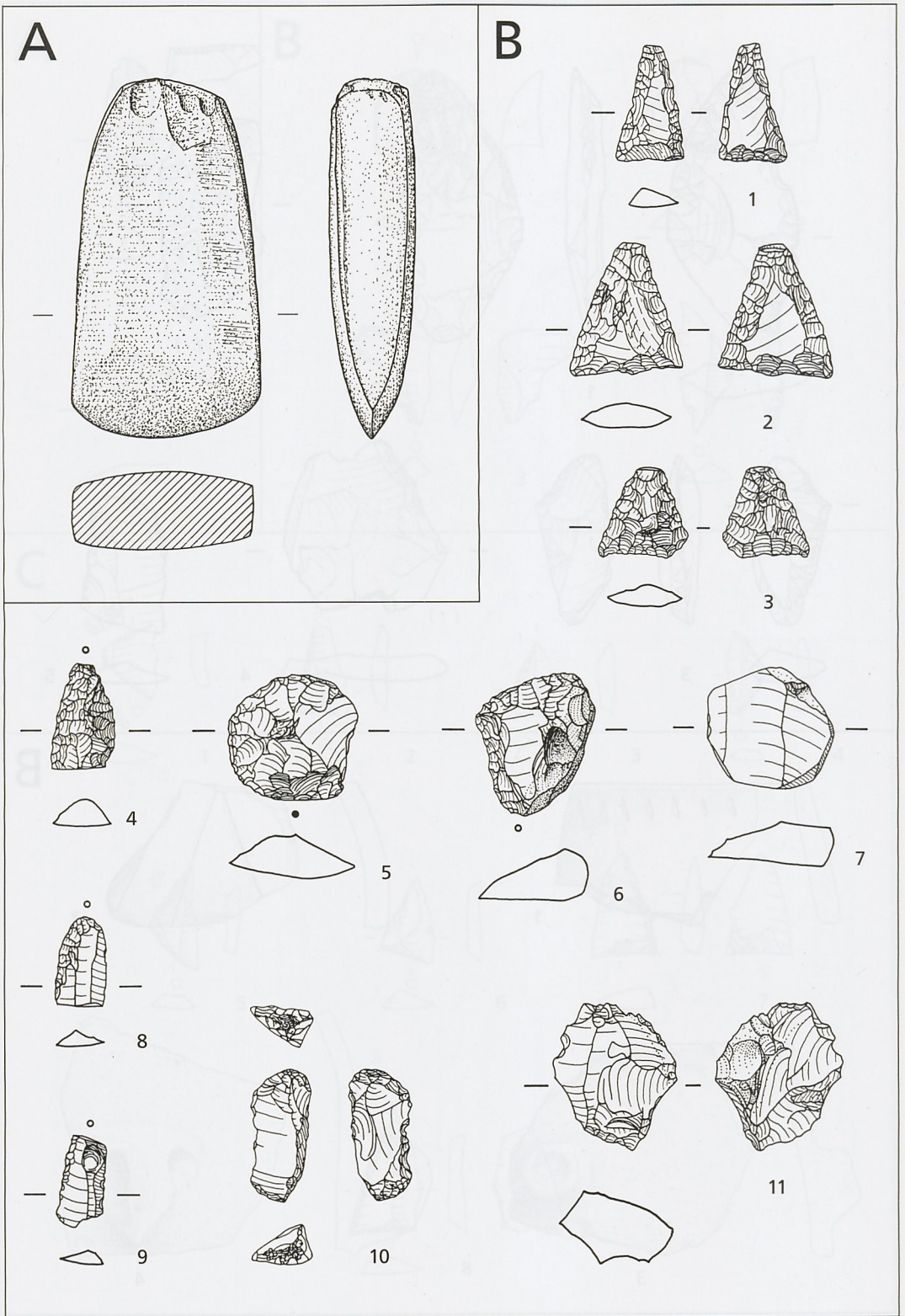

A Dossenheim (Rhein-Neckar-Kreis). M 2 : 3. – B Efringen-Kirchen I s t e i n (Lkr. Lörrach). M 2 : 3.

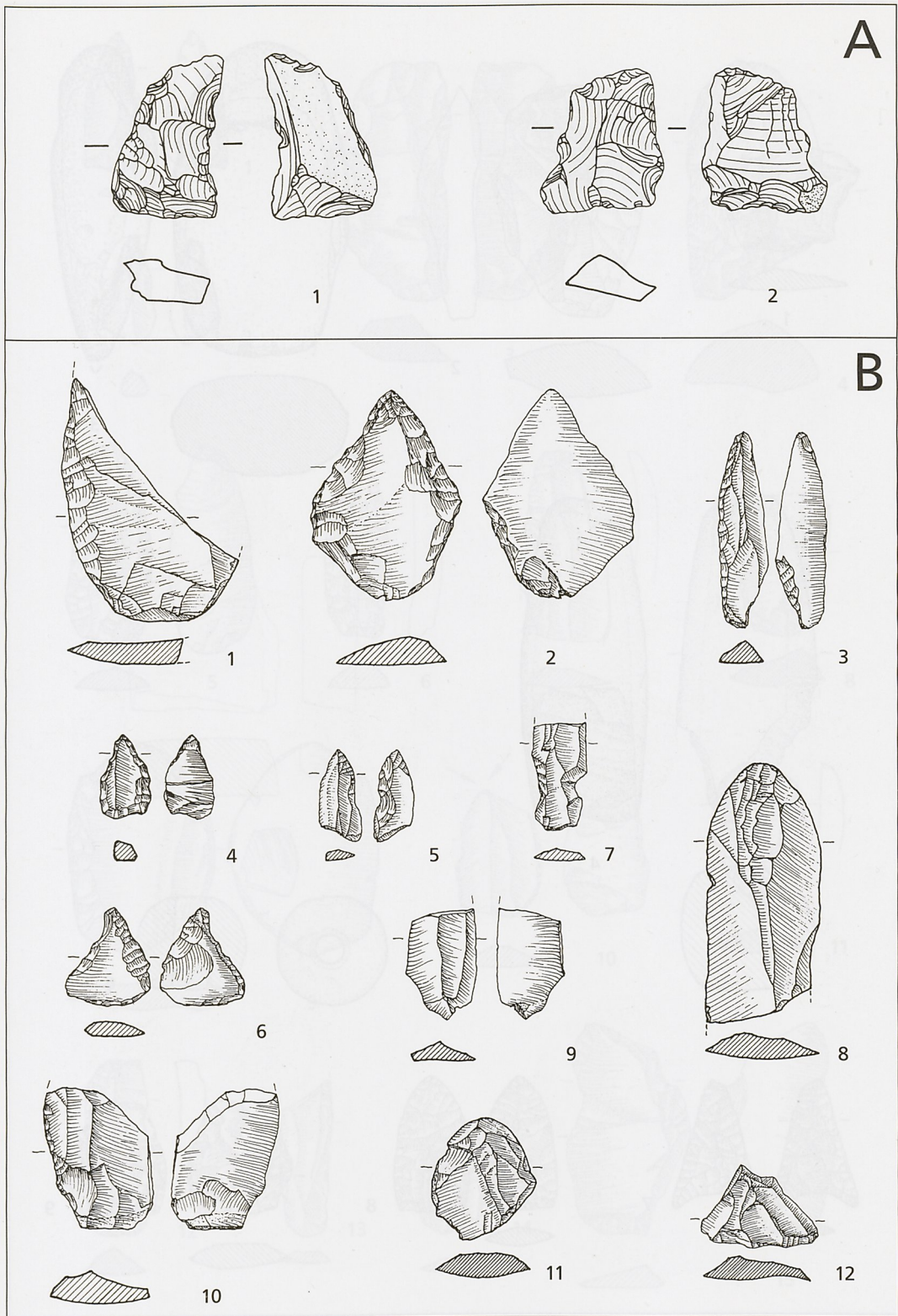

A Efringen-Kirchen Istein (Lkr. Lörrach). M 2 : 3. – B Ehrenkirchen Ehrenstetten (Kr. Breisgau-Hochschwarzwald). M 2 : 3.

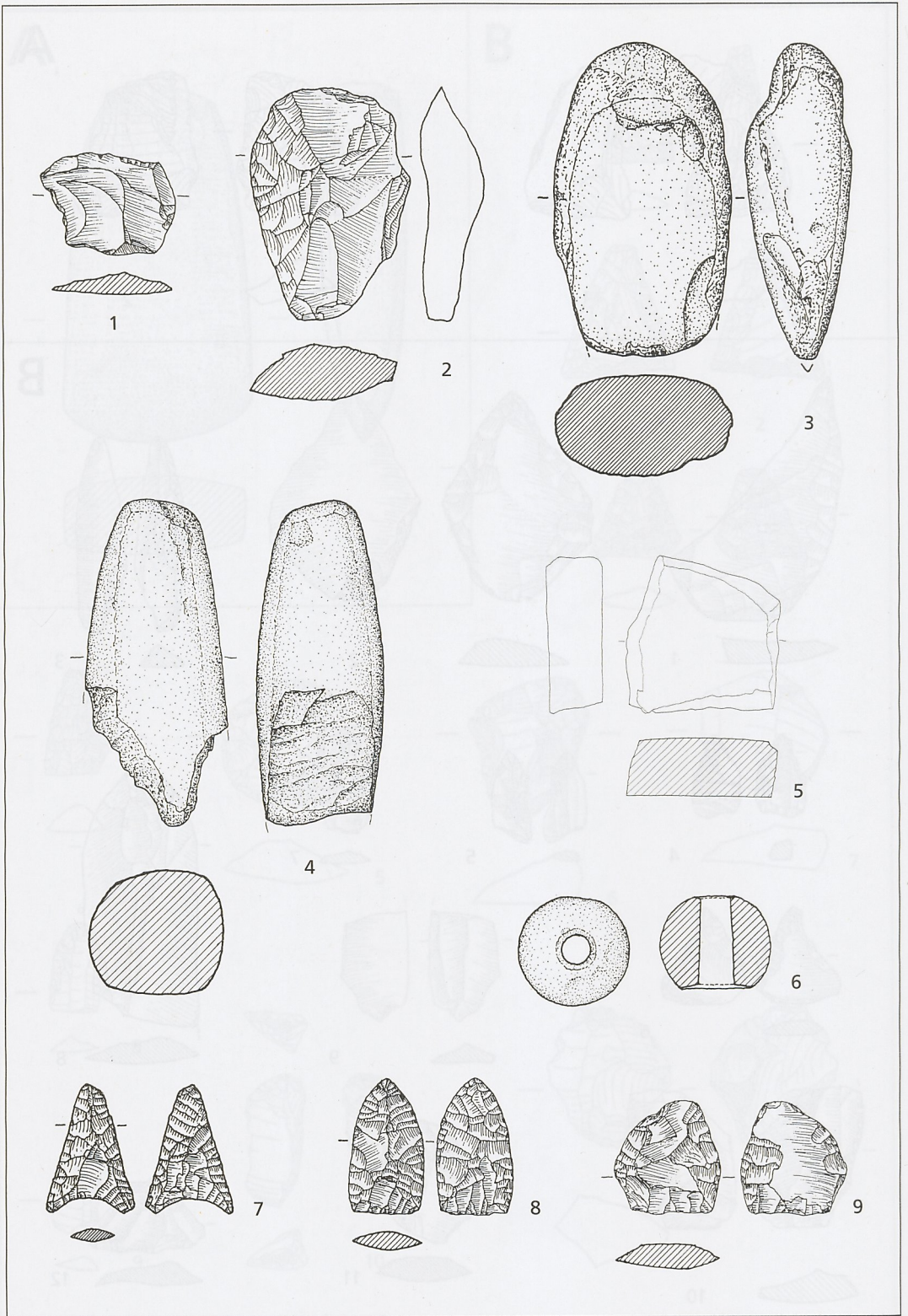

Ehrenkirchen Ehrenstetten (Kr. Breisgau-Hochschwarzwald). M 2 : 3.

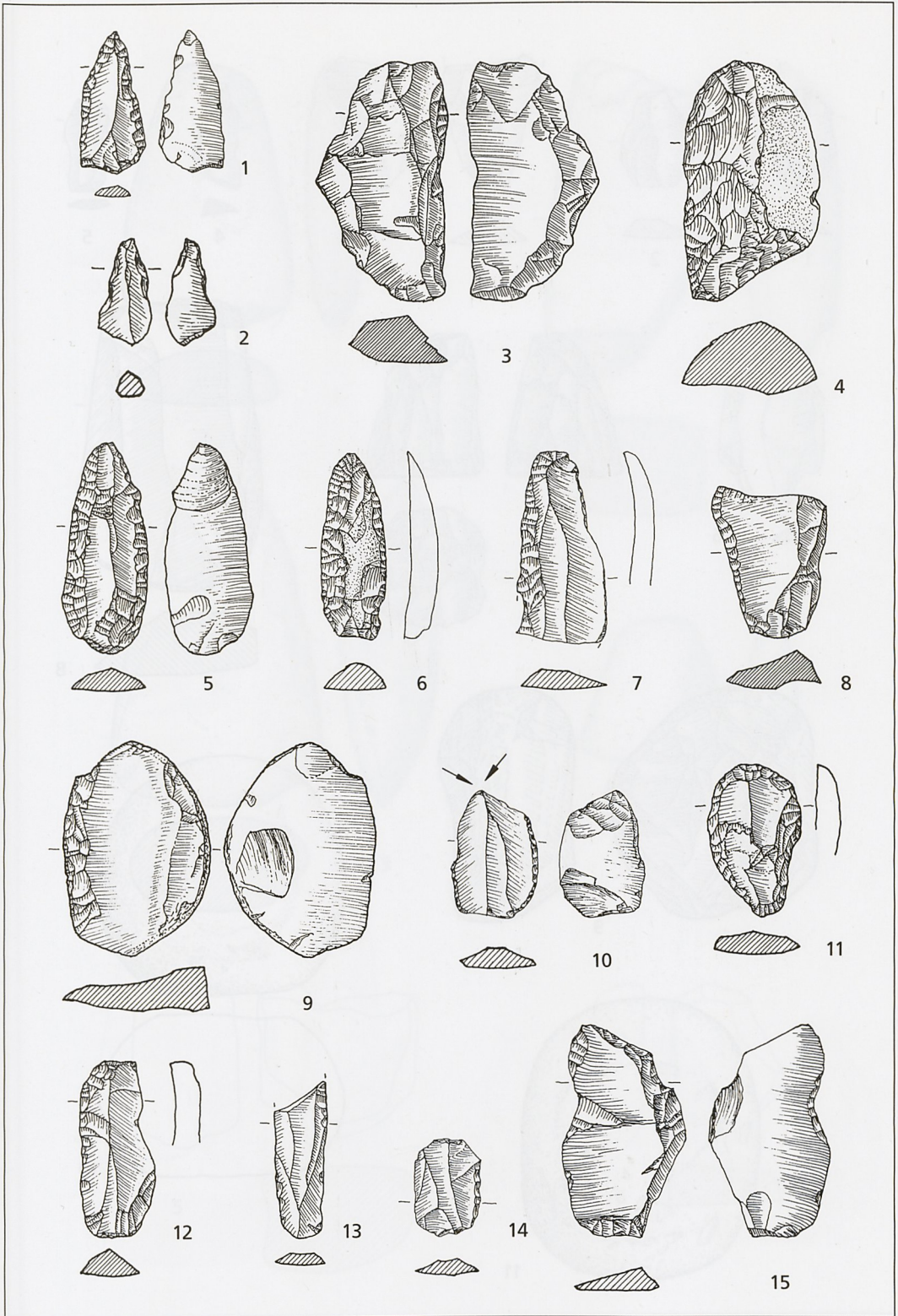

Ehrenkirchen Ehrenstetten (Kr. Breisgau-Hochschwarzwald). M 2:3.

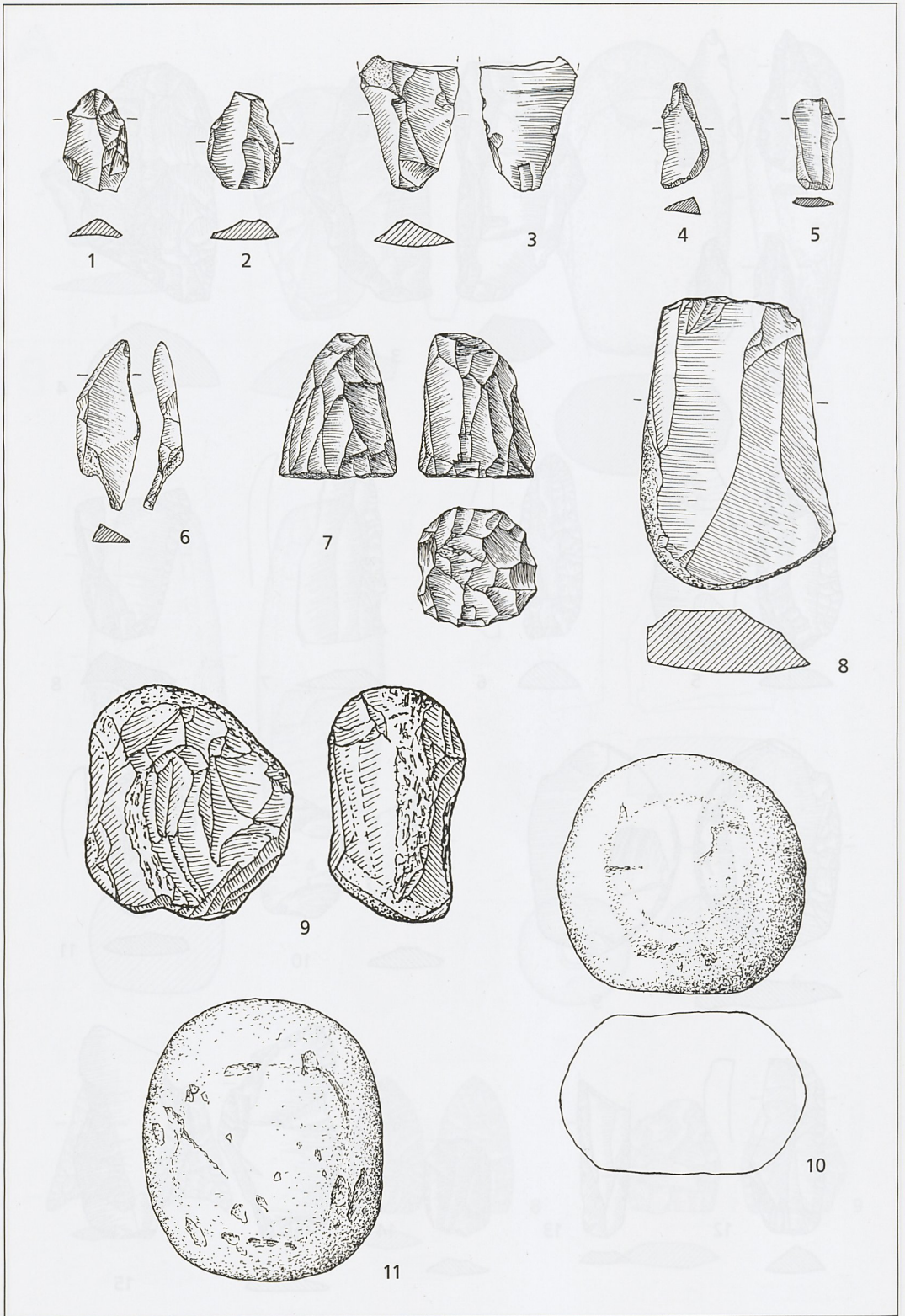

Ehrenkirchen Ehrenstetten (Kr. Breisgau-Hochschwarzwald). M 2 : 3.

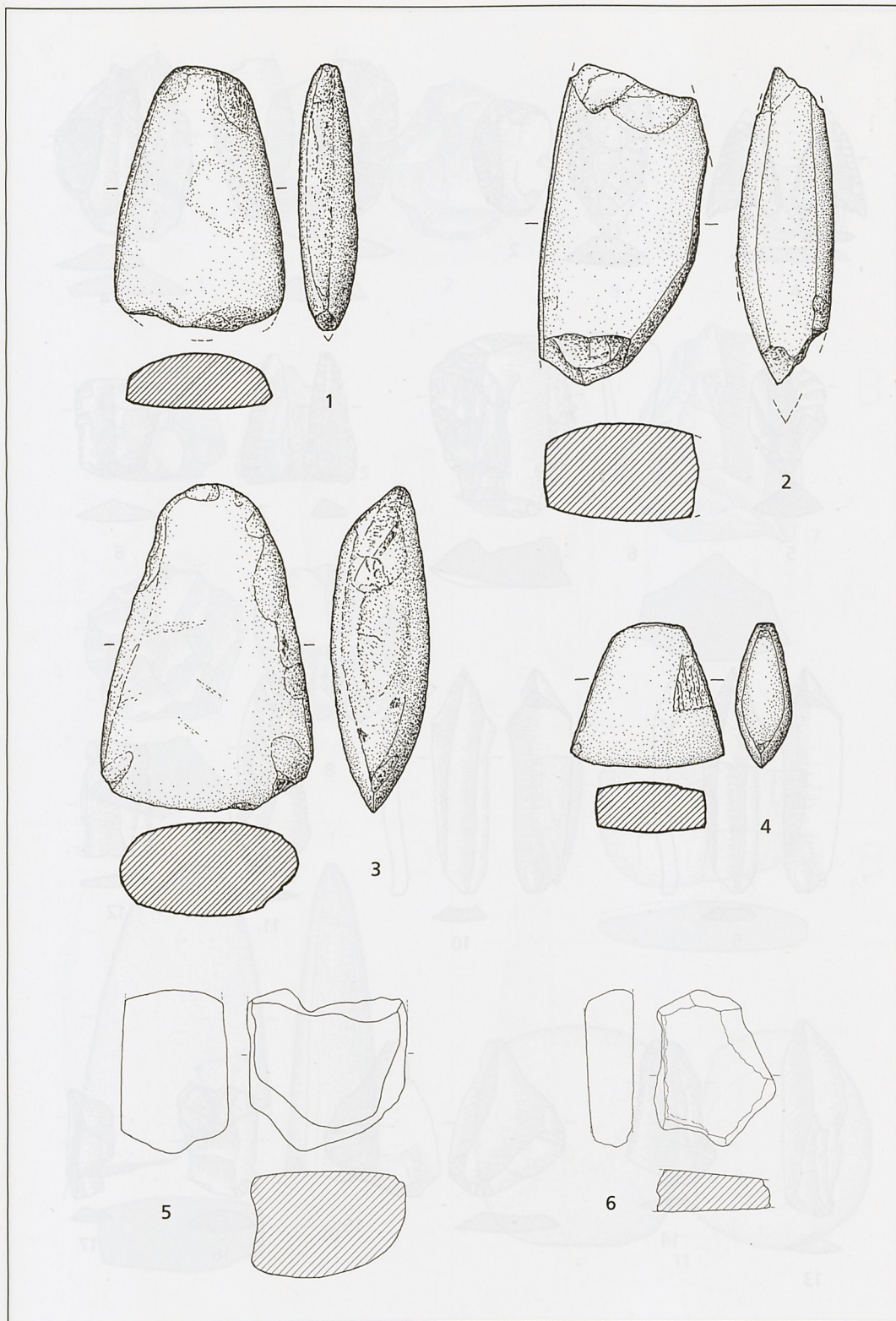

Ehrenkirchen Ehrenstetten (Kr. Breisgau-Hochschwarzwald). M 2 : 3.

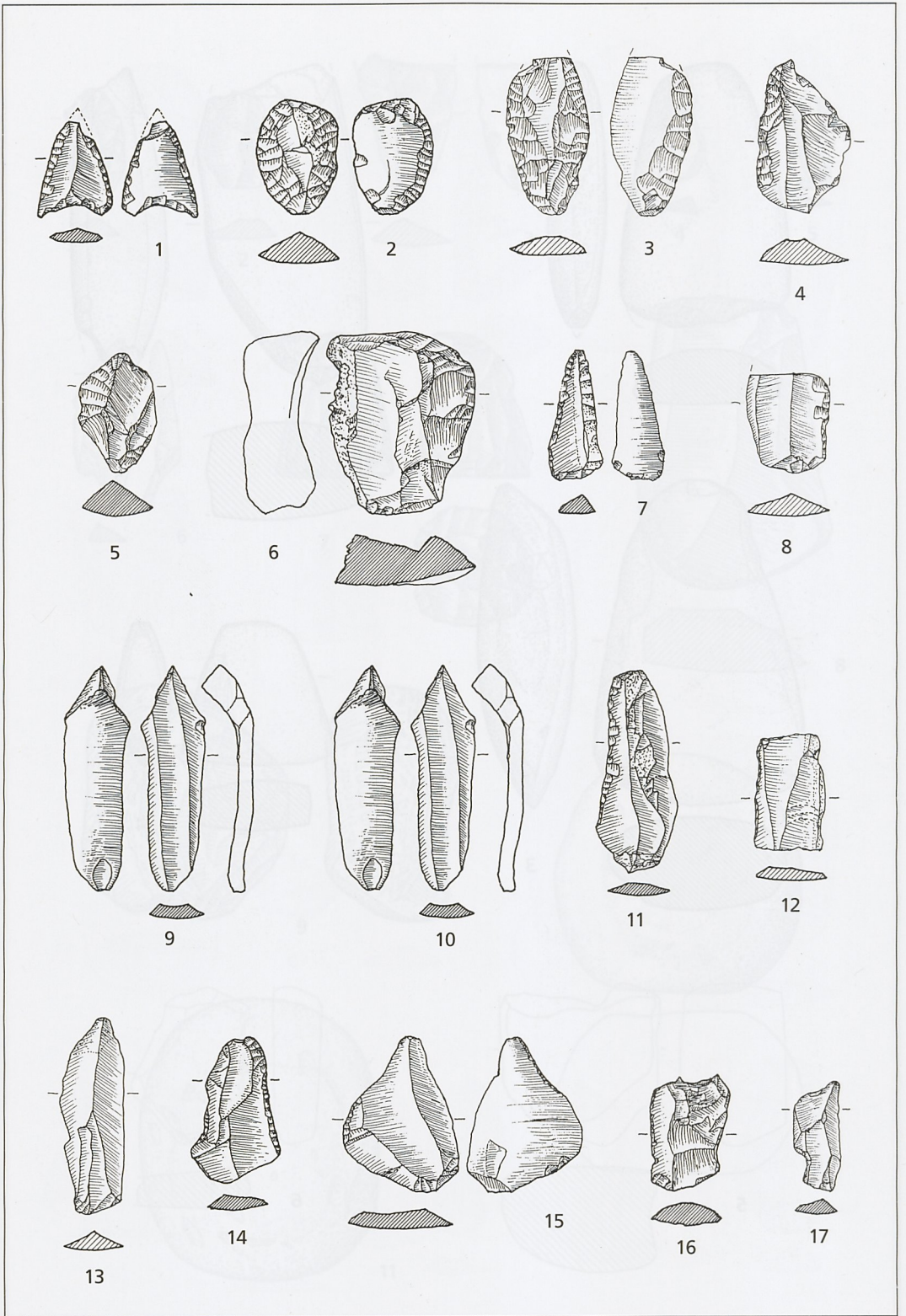

Ehrenkirchen Ehrenstetten (Kr. Breisgau-Hochschwarzwald). M 2 : 3.

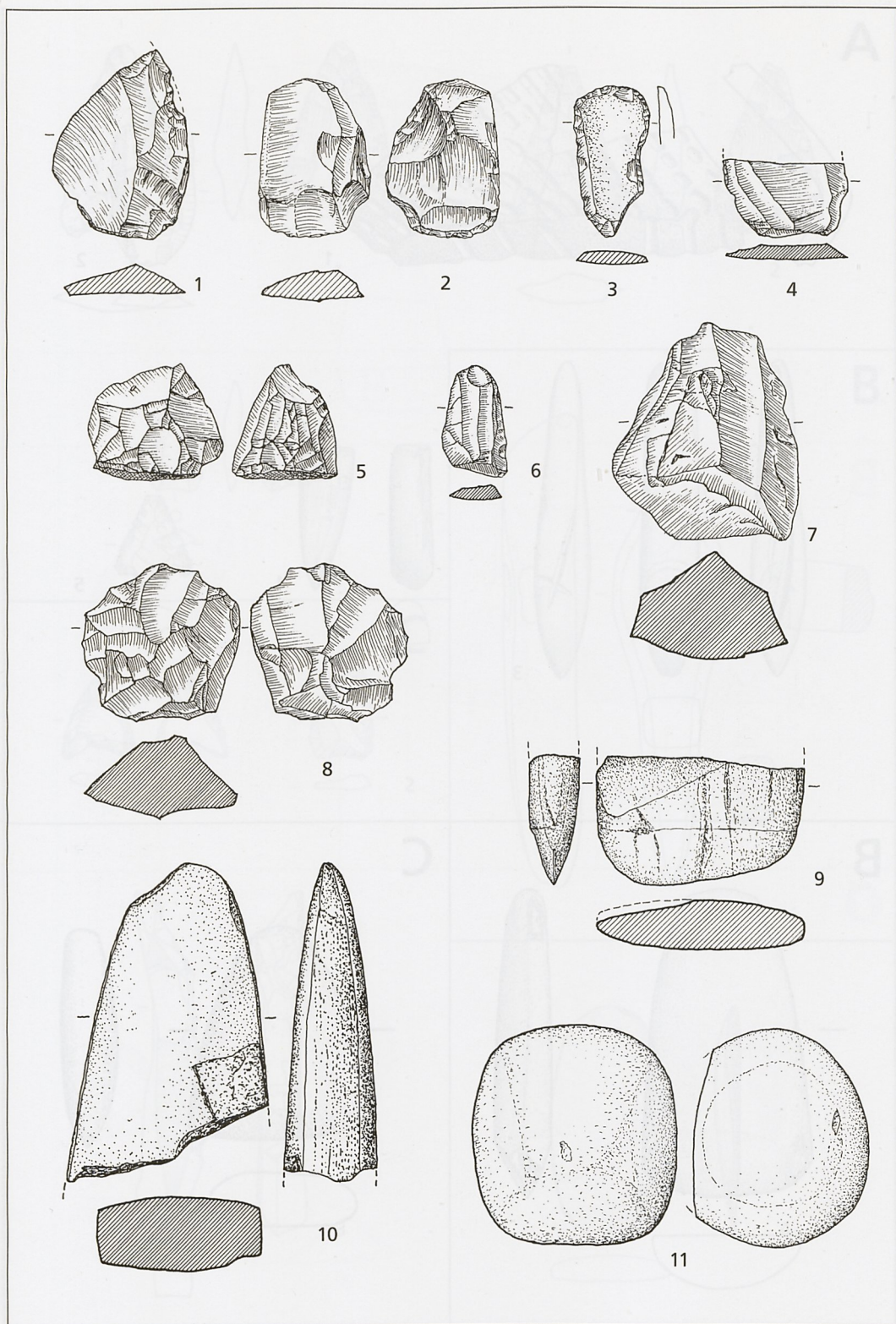

Ehrenkirchen Ehrenstetten (Kr. Breisgau-Hochschwarzwald). M 2 : 3.

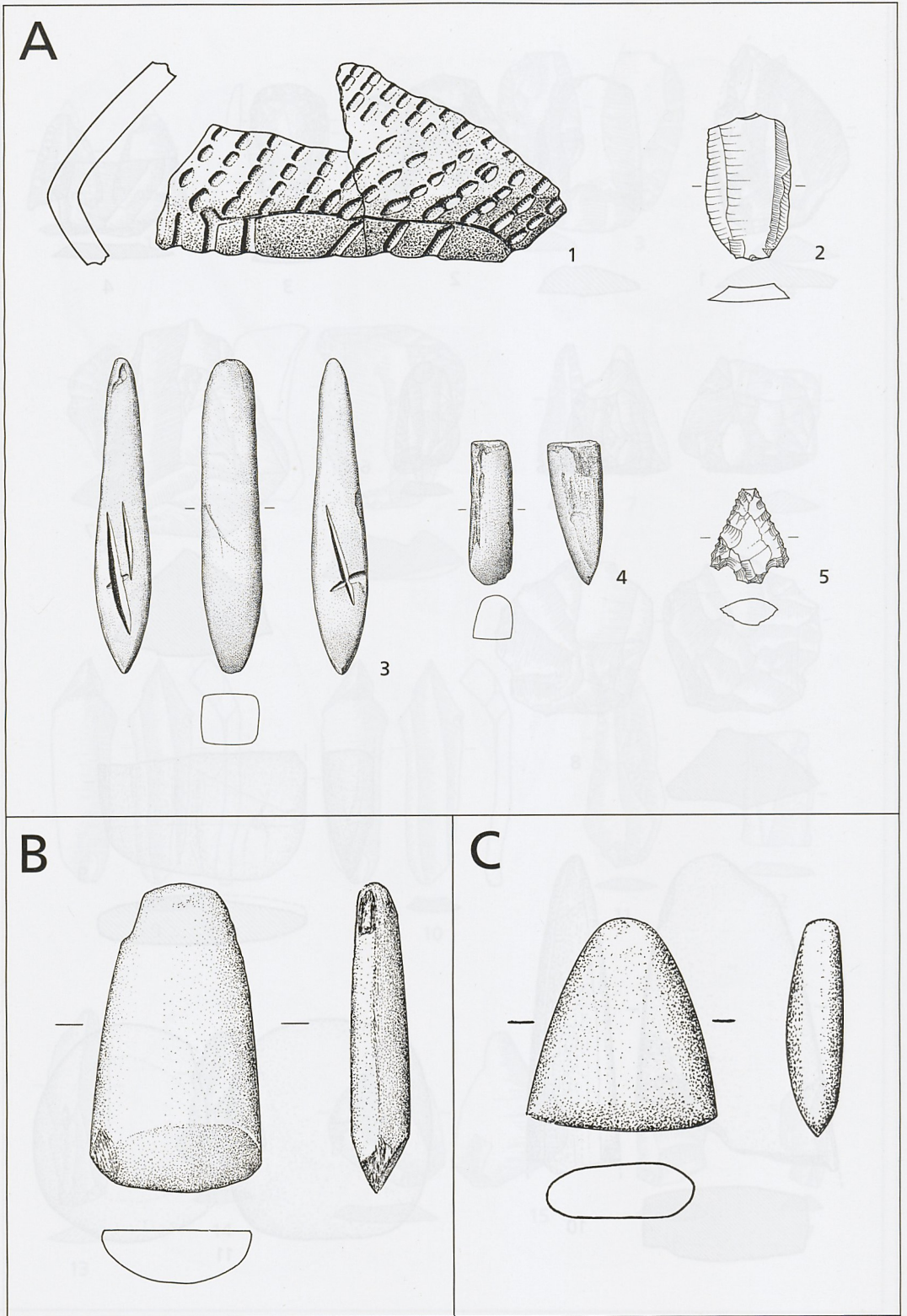

A Gerlingen (Lkr. Ludwigsburg). 1 M 1:3; 2.5 M 2:3; 3.4 M 1:2. -
B Heidelberg Handschuhsheim. M 1:3. - C Heidelberg Kirchheim. M 1:3.

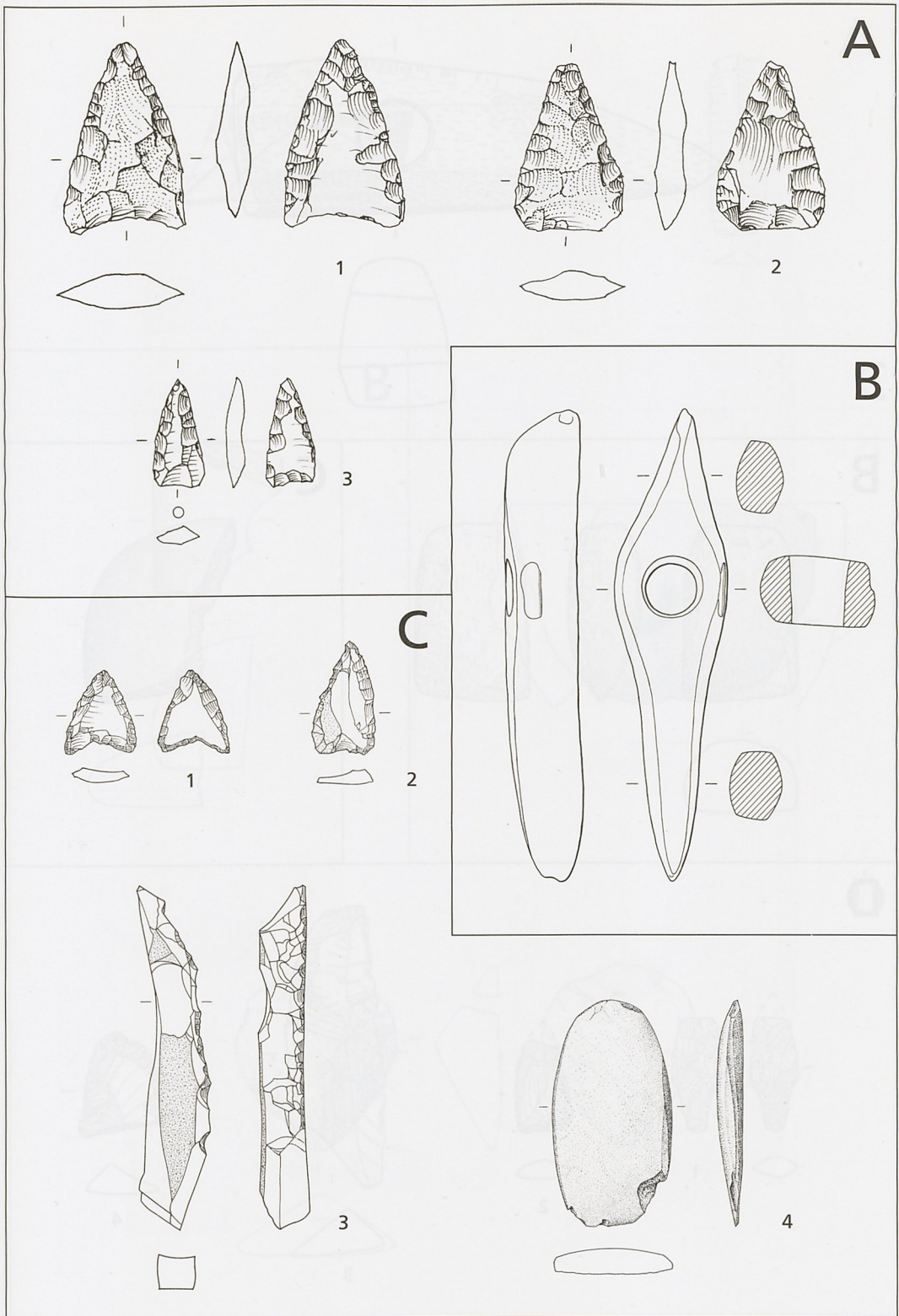

A Heubach (Ostalbkreis). M 1 : 1. – B Konstanz (Lkr. Konstanz). M 1 : 3. – C Korntal-Münchingen M ü n c h i n g e n (Lkr. Ludwigsburg). 1 Fdst. 2; 2–4 Fdst. 3. M 2 : 3, 4 M 1 : 2.

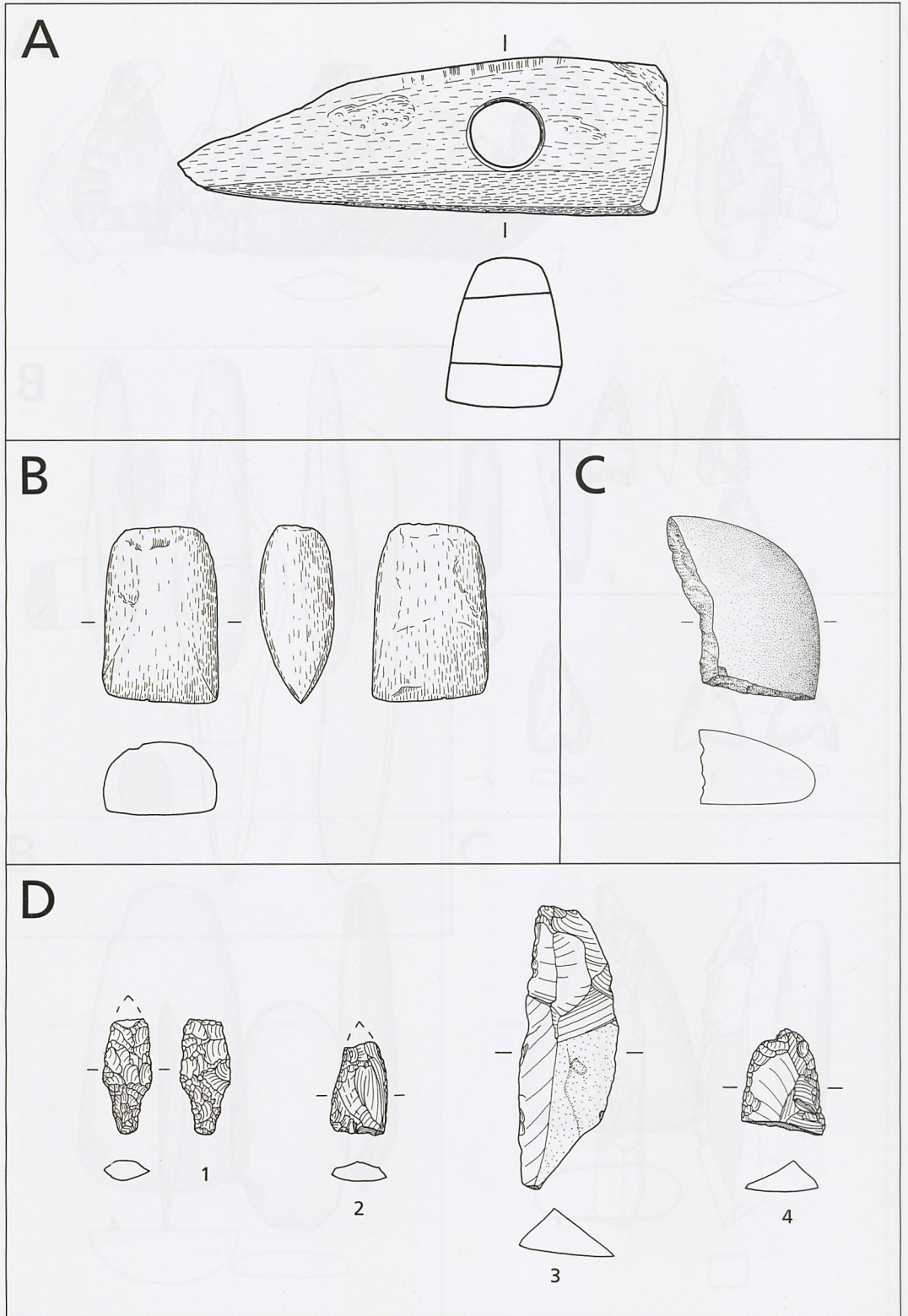

A Pfnzthal Berghausen (Lkr. Karlsruhe). M 1:2. - B Pfnzthal Söllingen (Lkr. Karlsruhe) M 1:2. - C Sachsenheim Großsachsenheim (Lkr. Ludwigsburg). M 1:2. - D Schliengen Liel (Lkr. Lörrach). M 1:2.

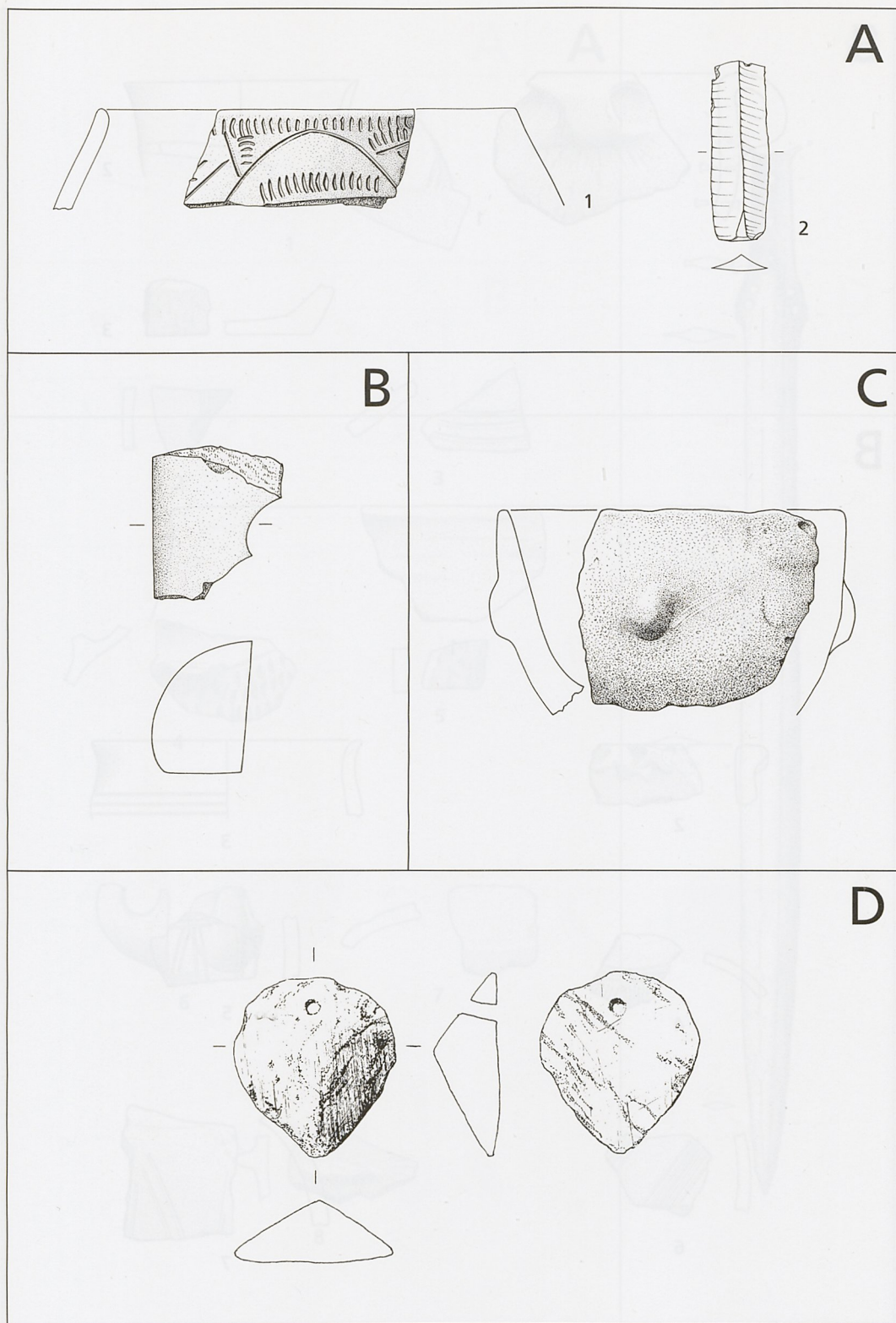

A Schwieberdingen (Lkr. Ludwigsburg). 1 Fdst. 3; 2 Fdst. 4. M 1 : 2. – B Sersheim (Lkr. Ludwigsburg). M 2 : 3. – C Tamm (Lkr. Ludwigsburg), M 2 : 3. – D Weil der Stadt M e r k l i n g e n (Lkr. Böblingen) M 1 : 1.

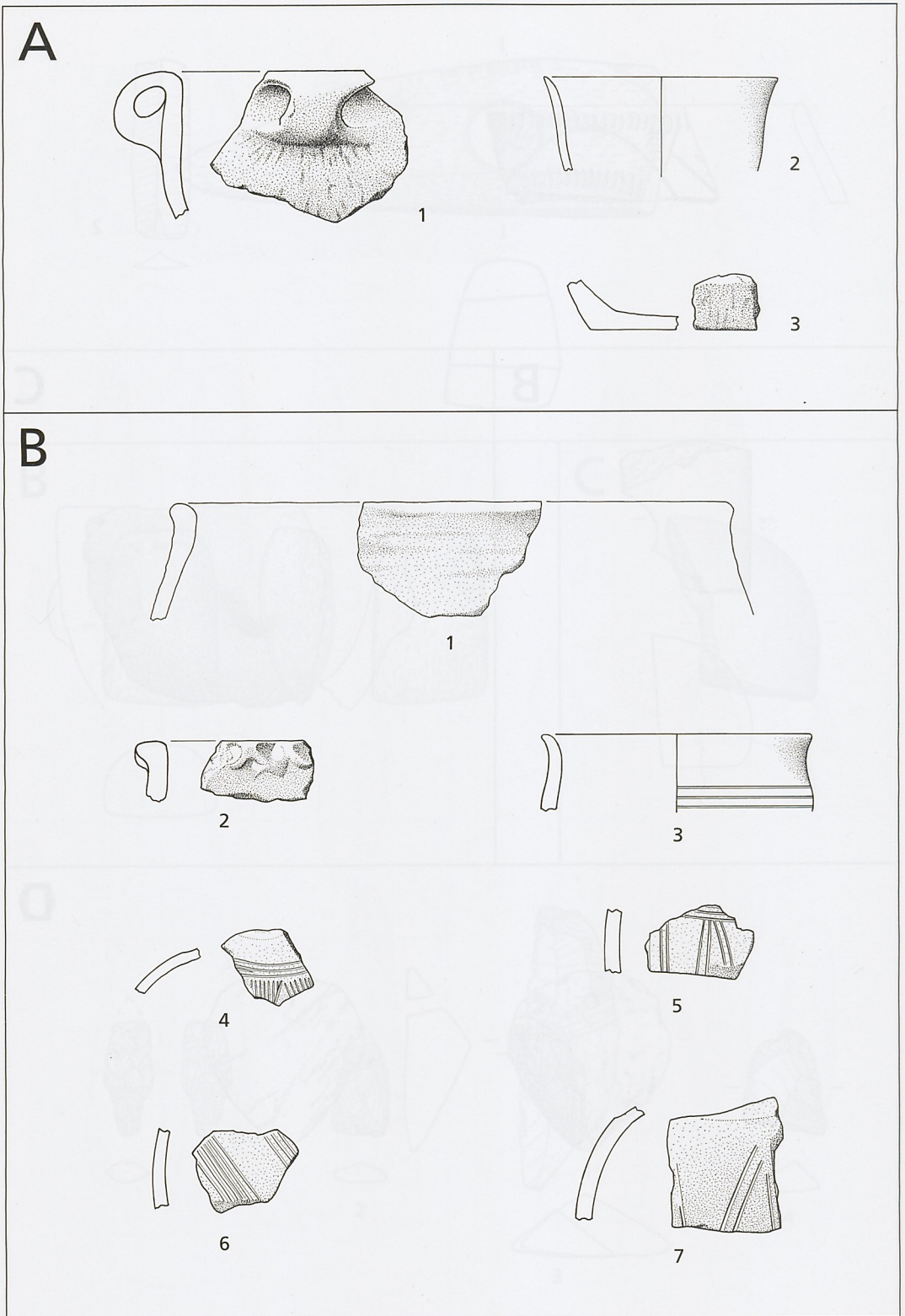

A Breisach am Rhein Oberrimsingen (Kr. Breisgau-Hochschwarzwald). M 1 : 3. –
 B Kenzingen (Lkr. Emmendingen). M 1 : 3; 1 M 1 : 4.

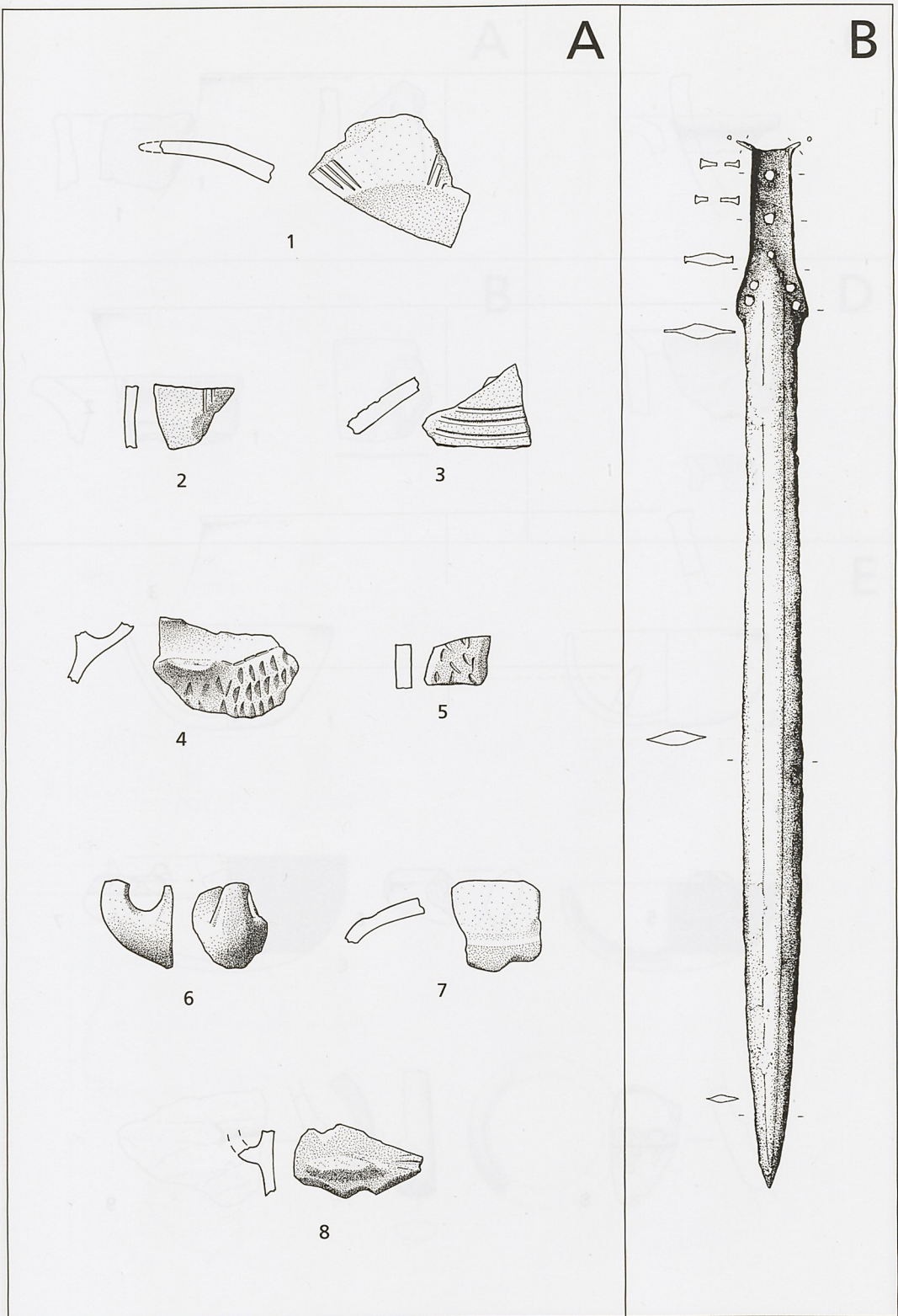

A Kenzingen (Lkr. Emmendingen). M 1 : 3. – B Konstanz (Lkr. Konstanz). M 1 : 4.

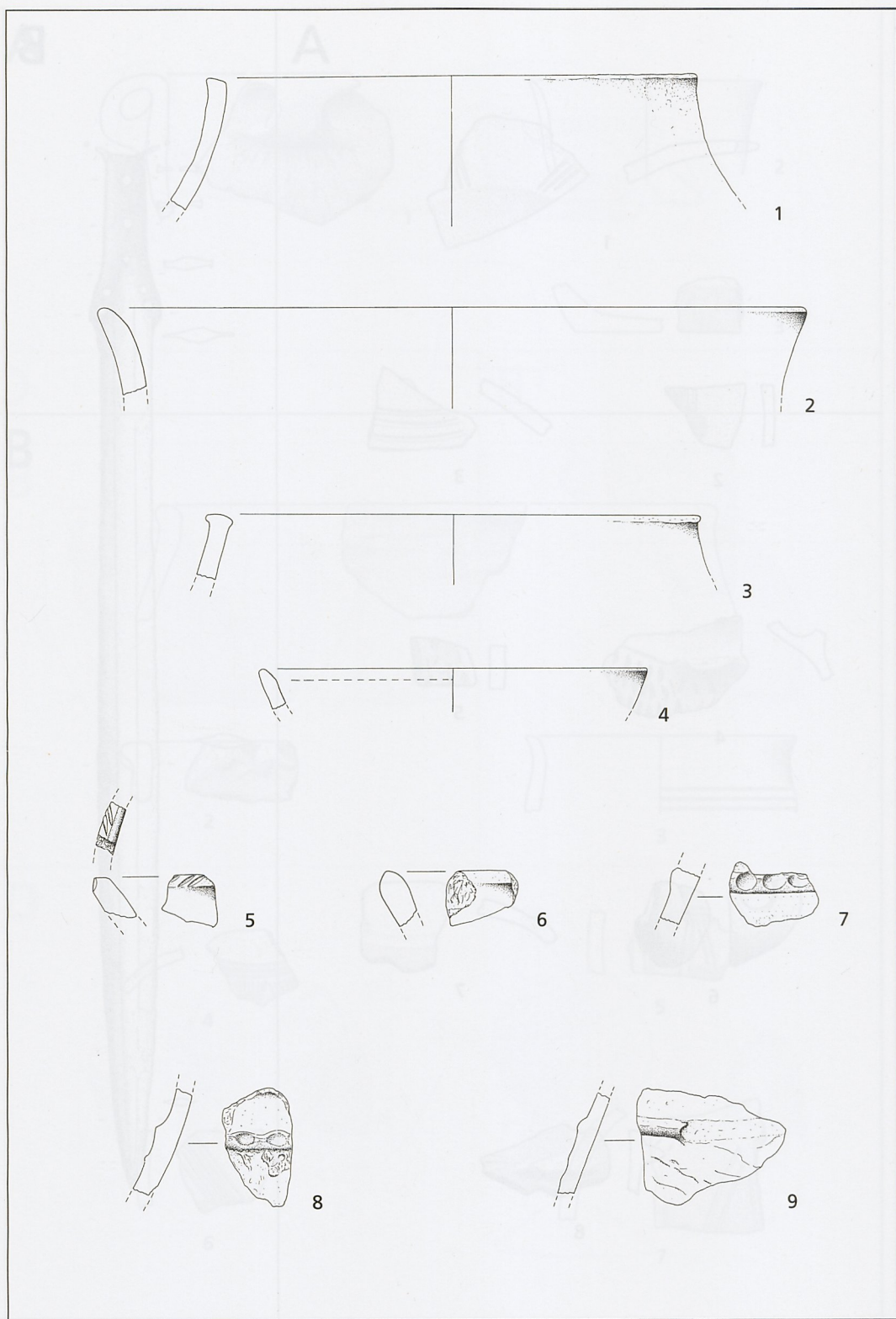

Tuttlingen (Lkr. Tuttlingen). M 1 : 3.

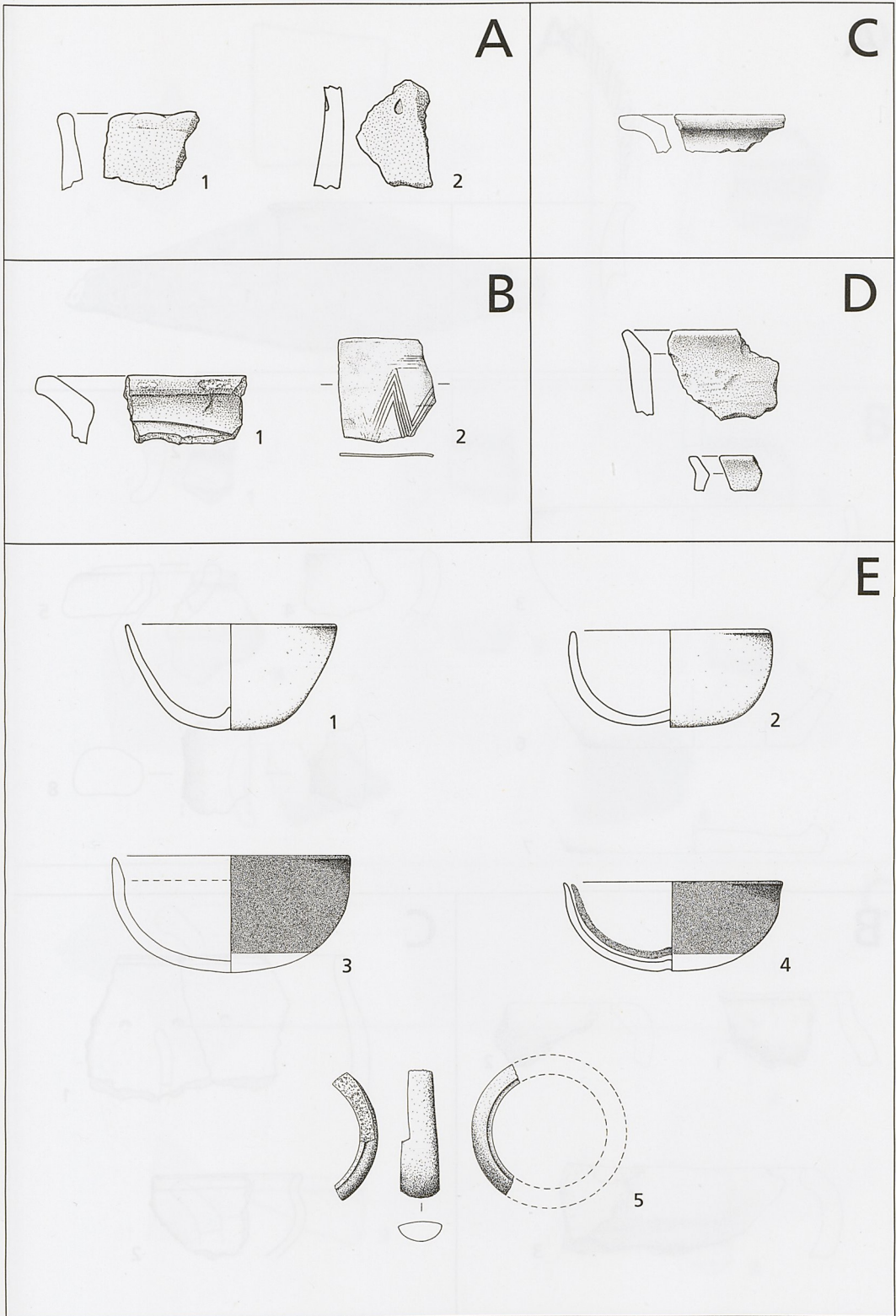

A Bad Krozingen Tunsel (Kr. Breisgau-Hochschwarzwald). M 1:3. - B Korntal-Münchingen Münchingen (Lkr. Ludwigsburg). Fdst. 2. M 2:3. - C Stuttgart Weilm Dorf. M 1:3. - D Ühlingen-Birkendorf Berau (Lkr. Waldshut). M 1:3. - E Reute (Lkr. Emmendingen). Fdst. 1. M 1:3.

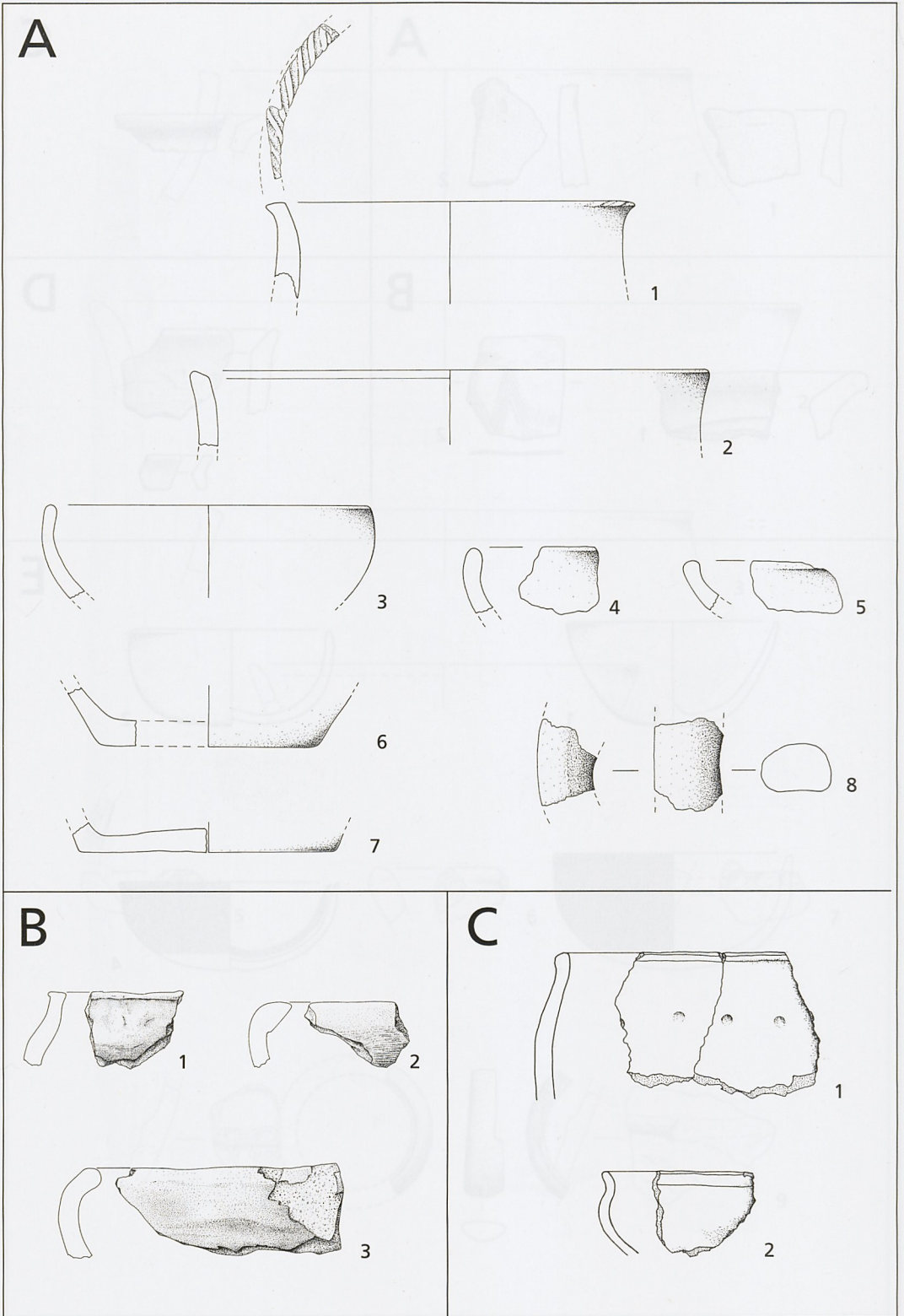

A Brigachtal Klengen (Schwarzwald-Baar-Kreis). M 1 : 3. – B Ditzingen (Lkr. Ludwigsburg). Fdst. 2. M 1 : 3. – C Edingen-Neckarhausen Neckarhausen (Rhein-Neckar-Kreis). M 1 : 2.

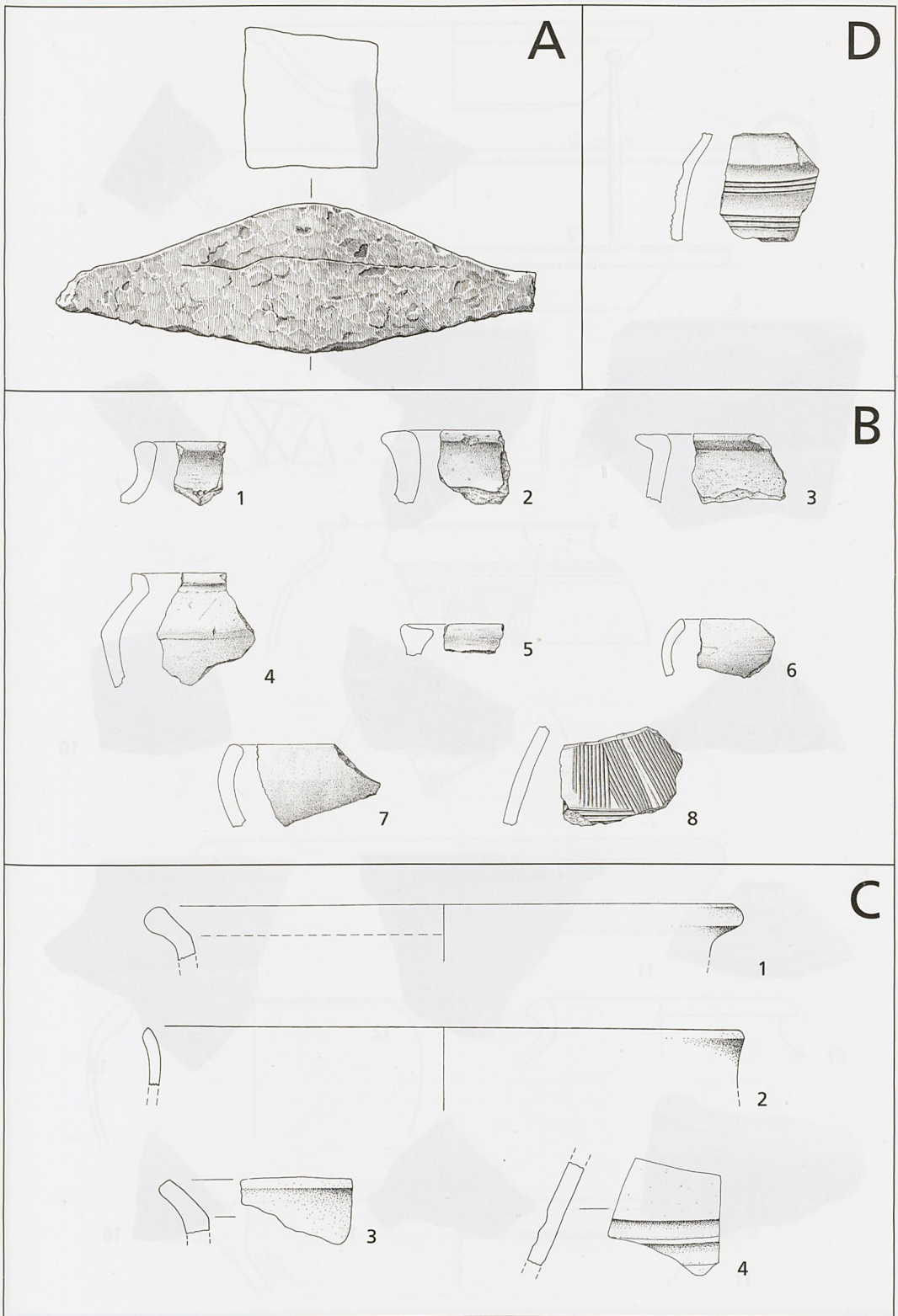

A Eschbronn Mariazell (Lkr. Rottweil). M 1:3. - B Korntal-Münchingen Münchingen (Lkr. Ludwigsburg). Fdst. 1. M 1:3. - C Tuttlingen (Lkr. Tuttlingen). M 1:3. - D Stuttgart Weilimdorf. M 1:3.

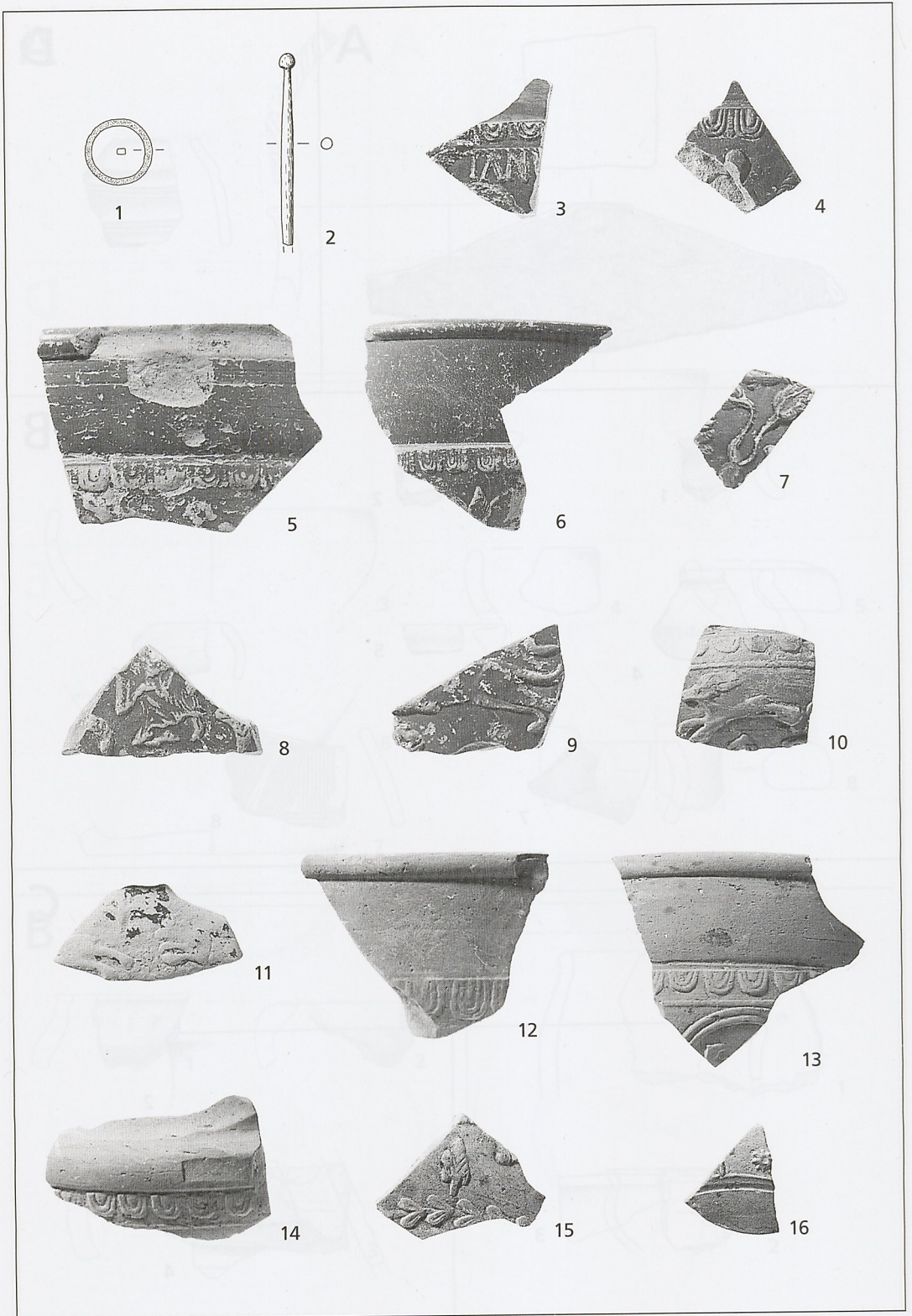

Aalen (Ostalbkreis). M 1 : 2.

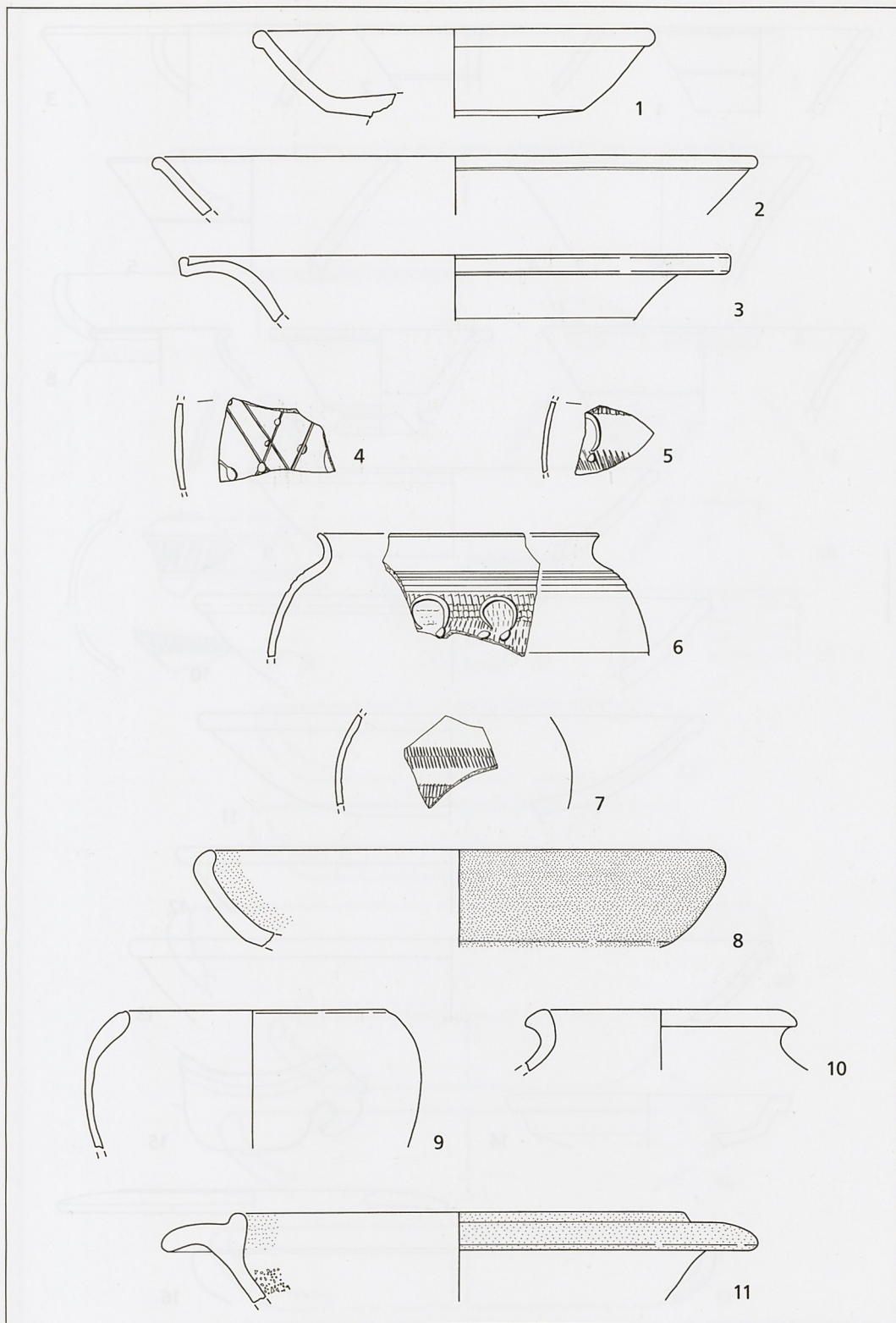

Aalen (Ostalbkreis). M 1 : 3.

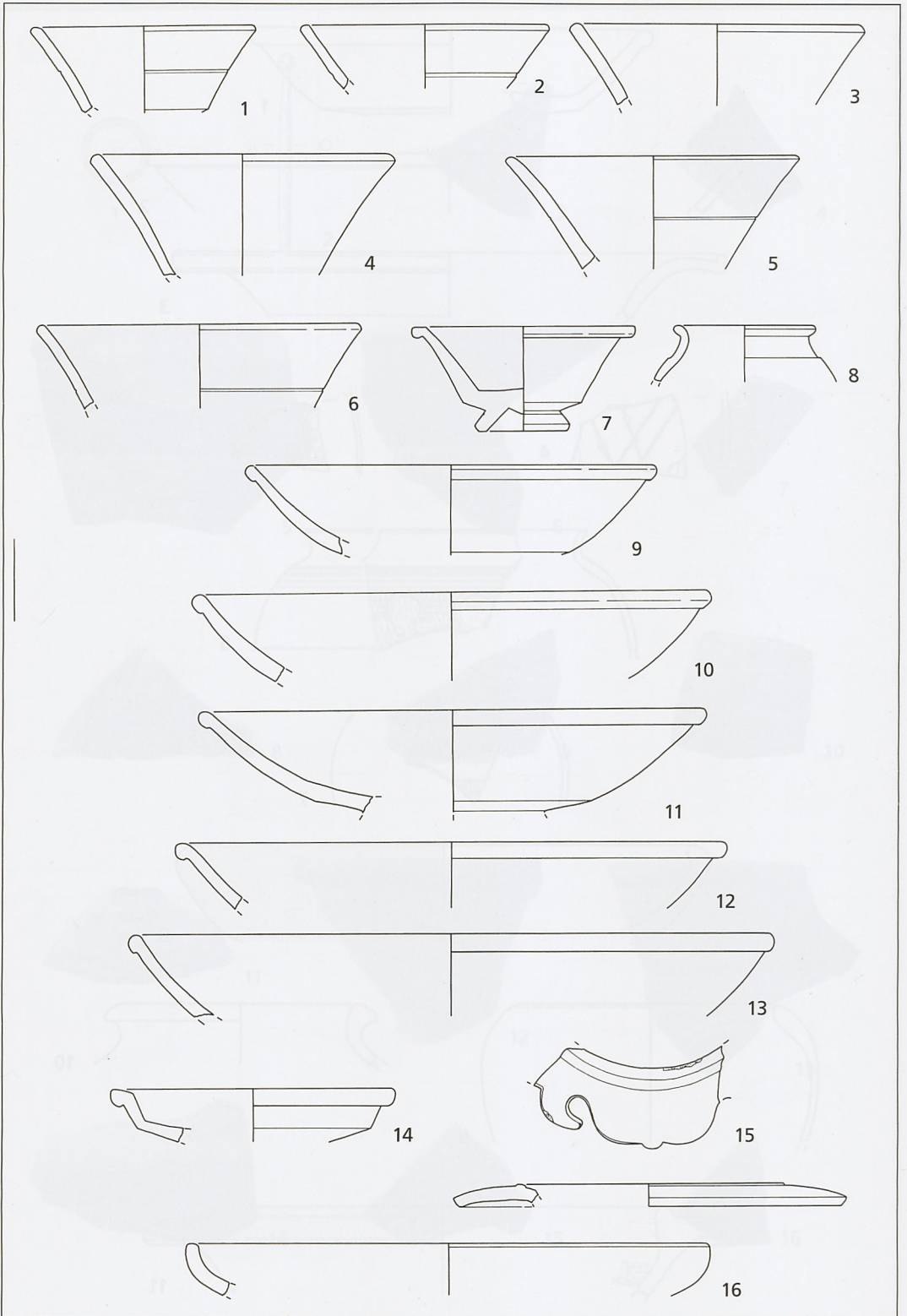

Aalen (Ostalbkreis). M 1 : 3.

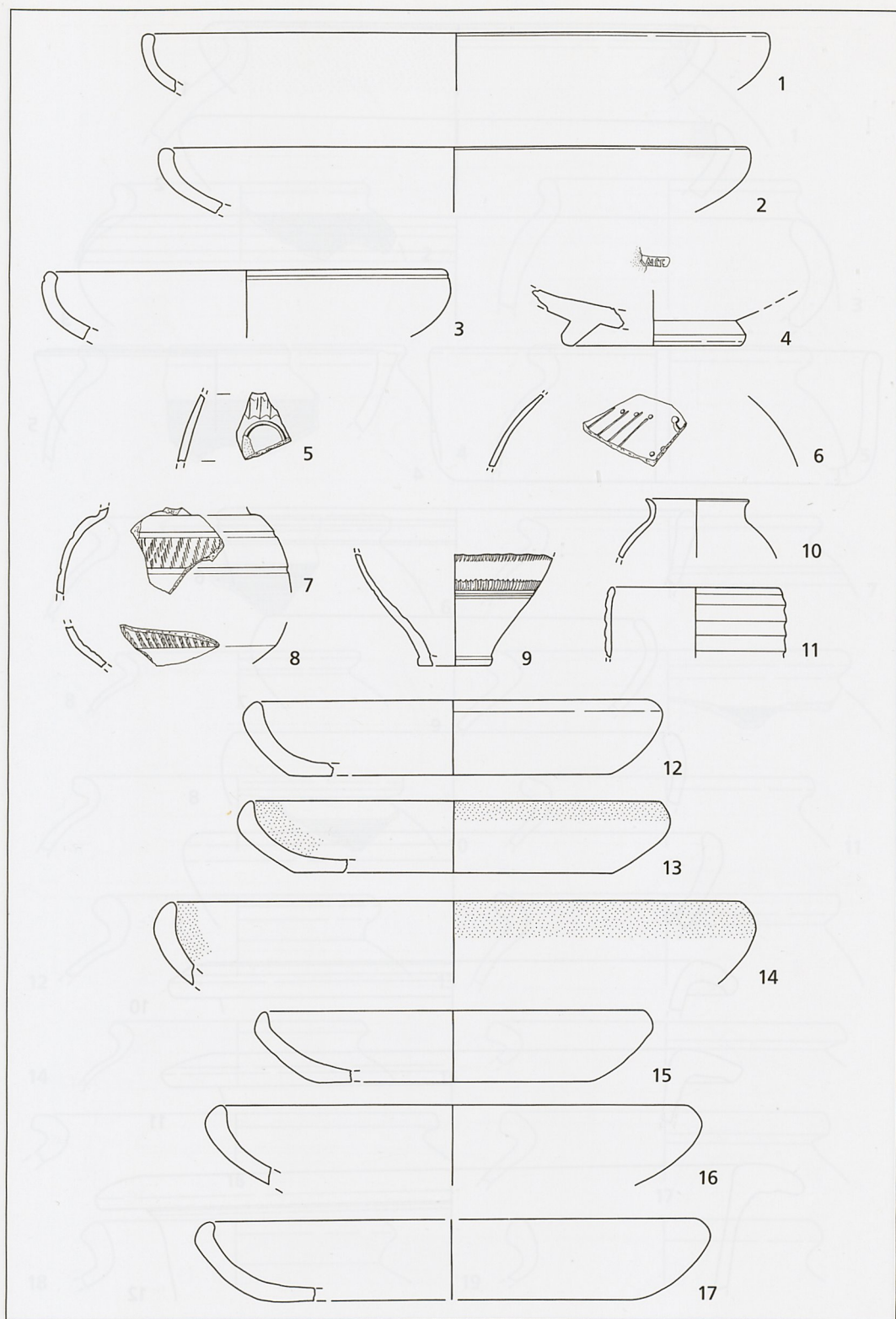

Aalen (Ostalbkreis). M 1 : 3.

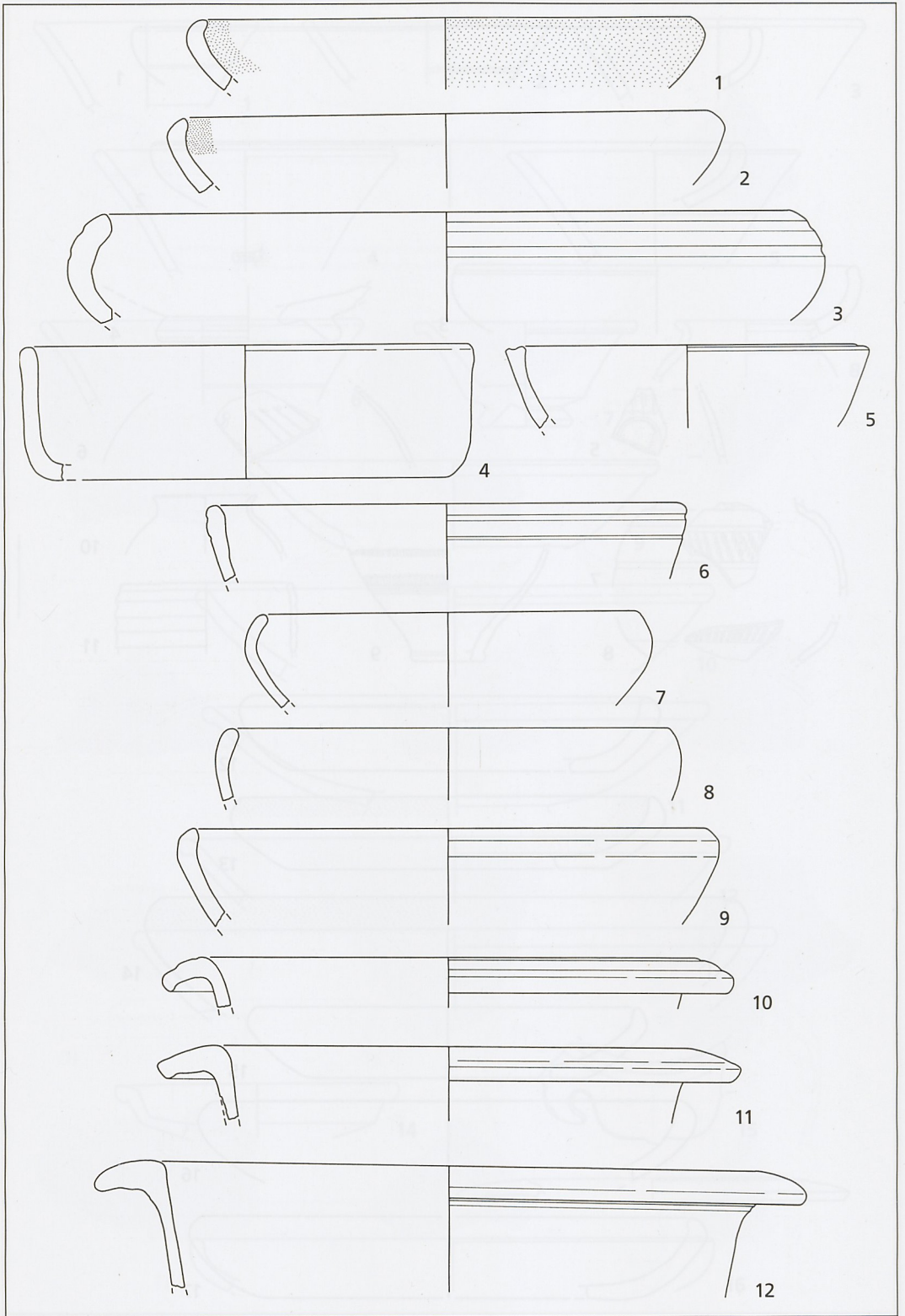

Aalen (Ostalbkreis). M 1 : 3.

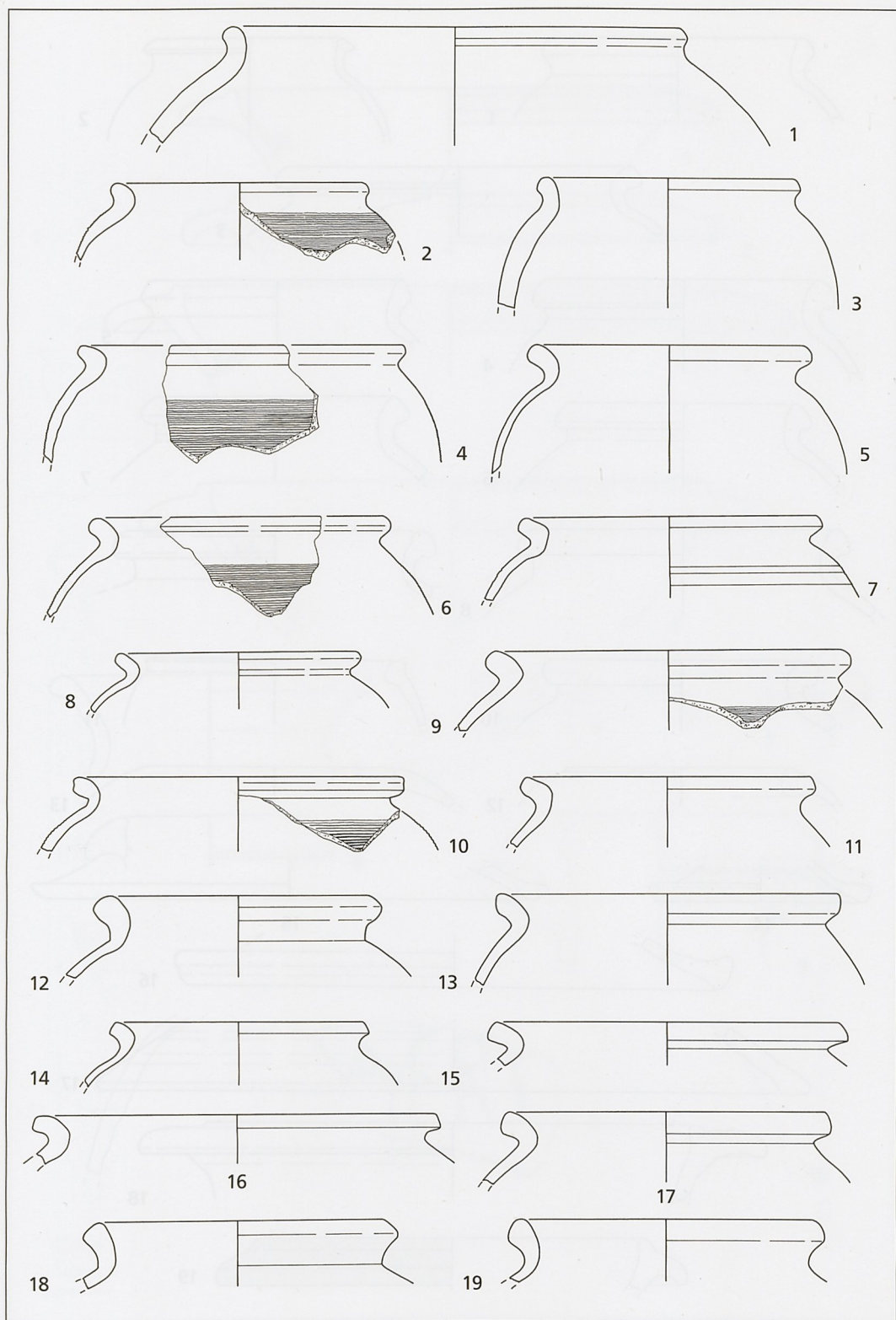

Aalen (Ostalbkreis). M 1 : 3.

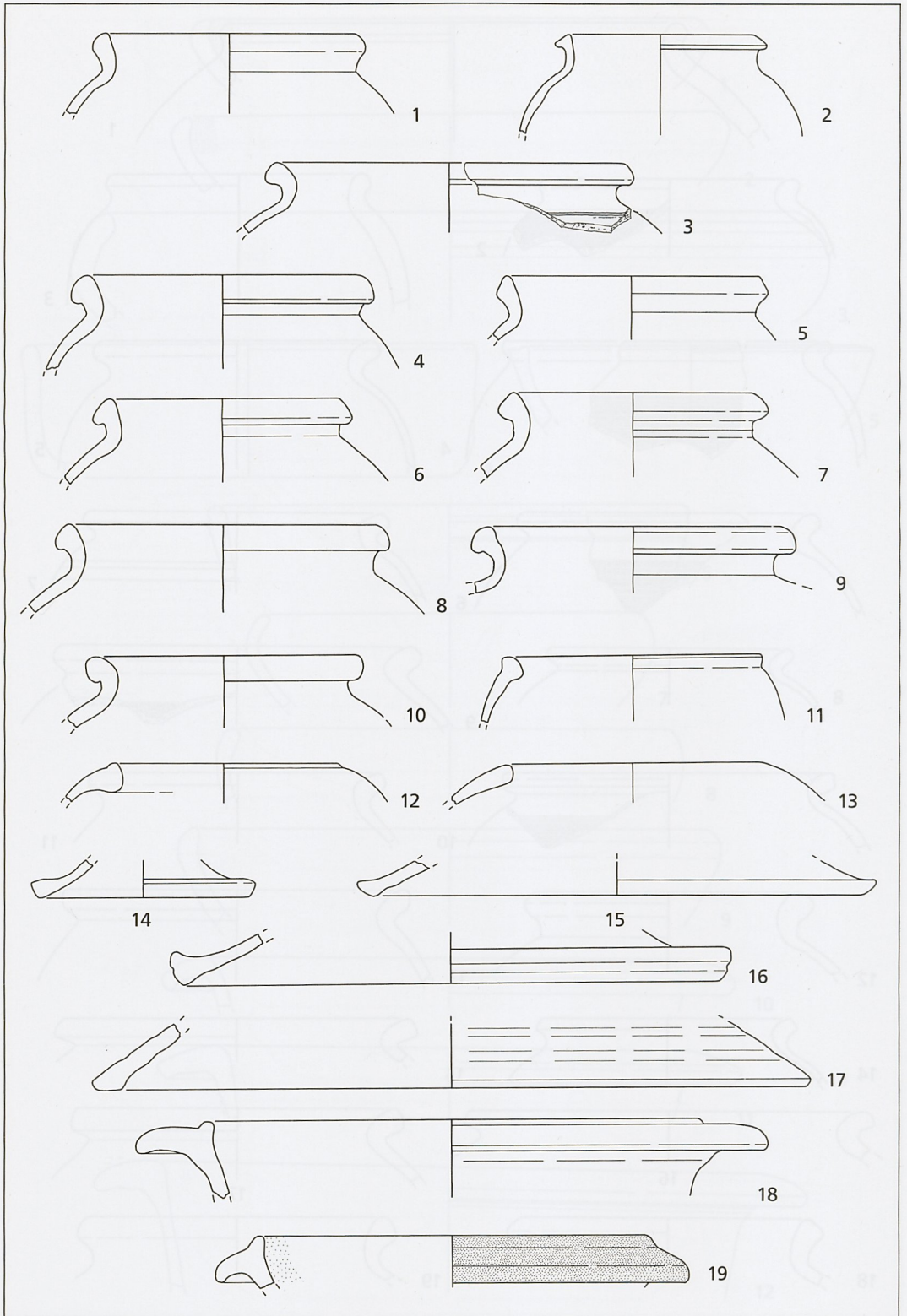

Aalen (Ostalbkreis). M 1 : 3.

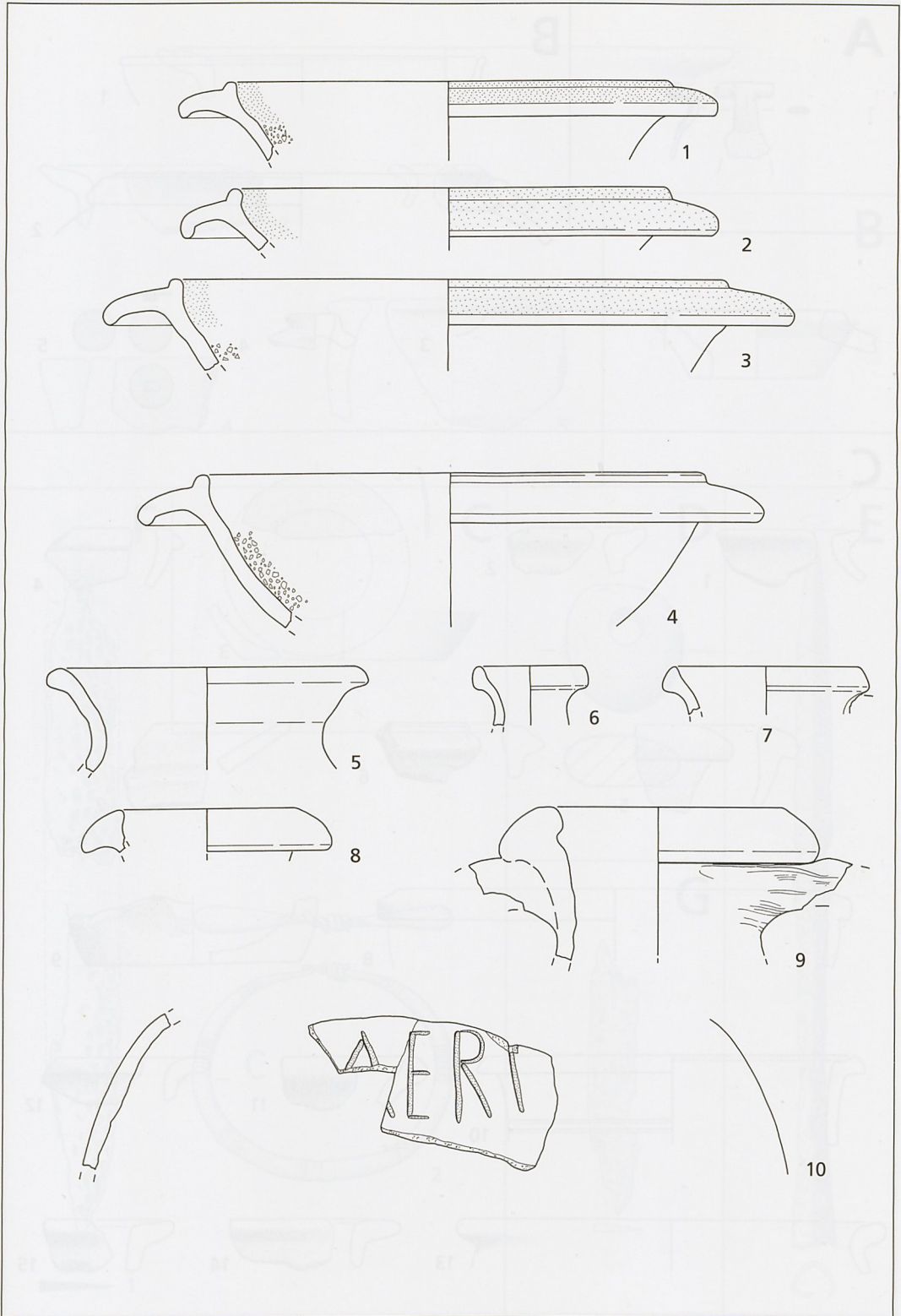

Aalen (Ostalbkreis). M 1 : 3.

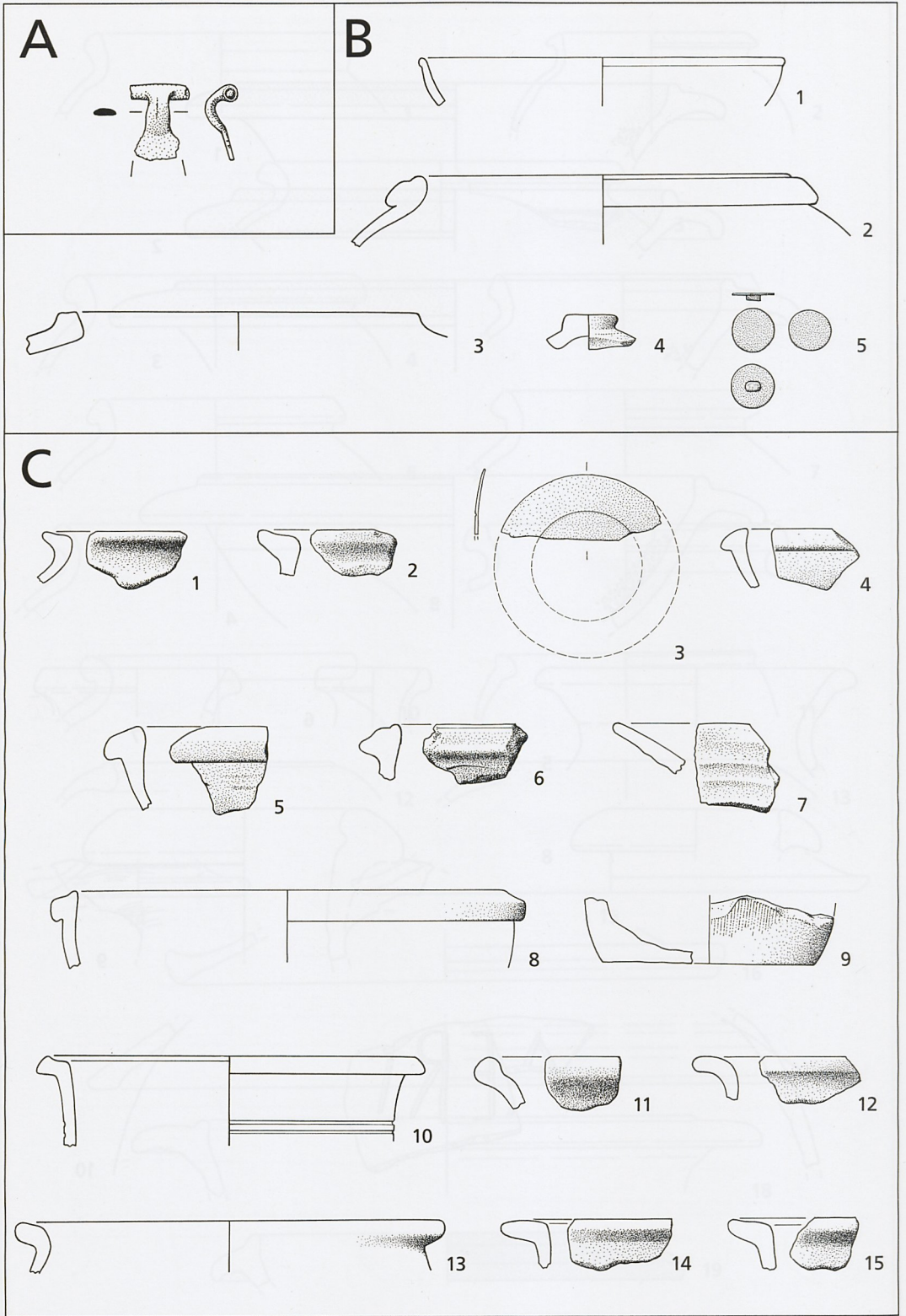

A Ehrenkirchen Ehrenstetten (Kr. Breisgau-Hochschwarzwald). M 2 : 3. – B Friesenheim Oberweier (Ortenaukreis). M 1 : 3. – C Gundelfingen (Kr. Breisgau-Hochschwarzwald). 1.2 Fdst. 1; 3 Fdst. 2; 4–7 Fdst. 3; 8.9 Fdst. 4; 10–15 Fdst. 5. M 1 : 3.

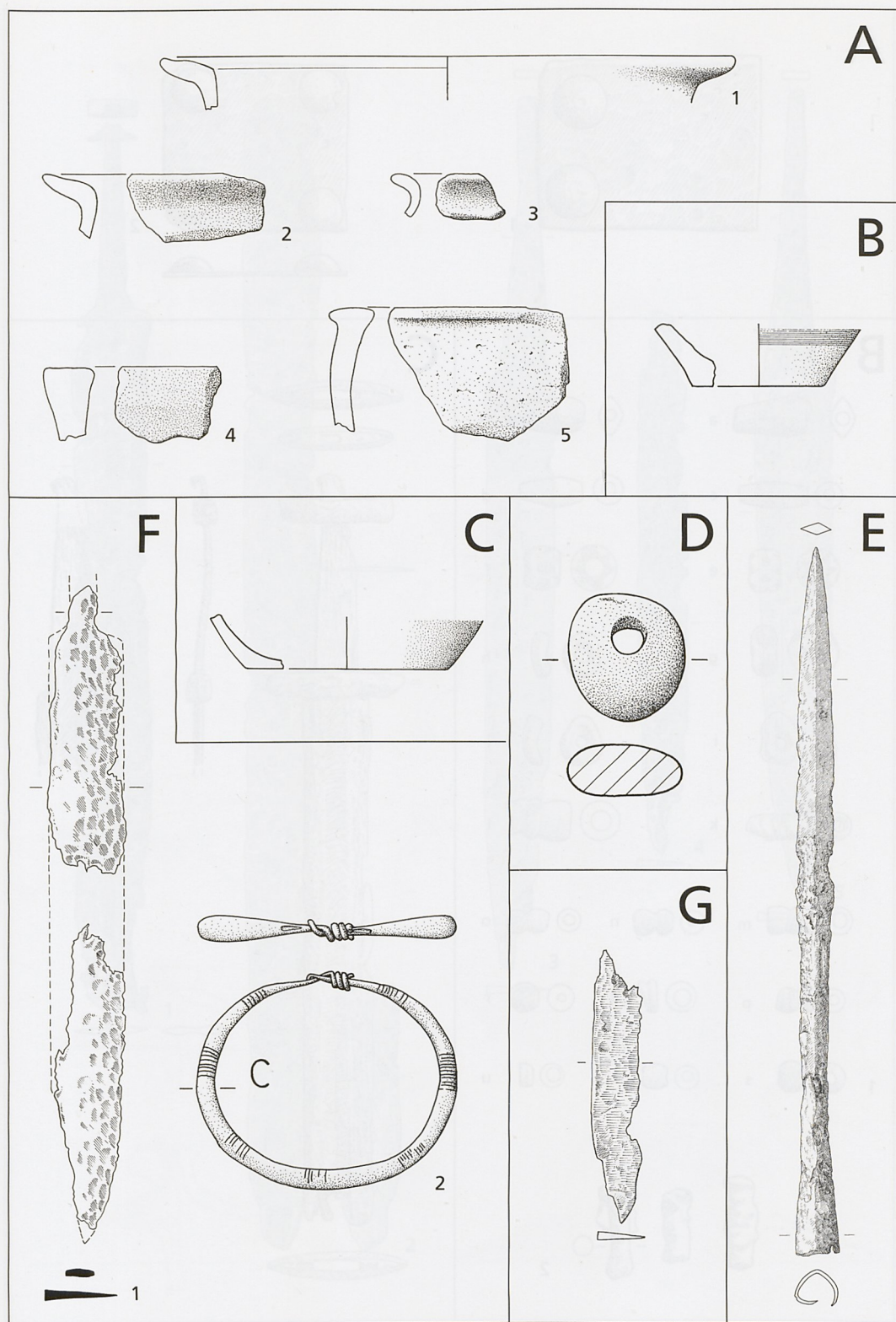

A Gundelfingen (Kr. Breisgau-Hochschwarzwald). 1-5 Fdst. 5. M 1 : 3. - B Kenzingen (Lkr. Emmendingen). M 1 : 3. - C Bad Krozingen T u n s e l (Kr. Breisgau-Hochschwarzwald). Fdst. 2. M 1 : 3. - D Ballrechten-Dottingen D o t t i n g e n (Kr. Breisgau-Hochschwarzwald). Fdst. 1. M 1 : 2. - E Ditzingen (Lkr. Ludwigsburg). M 1 : 4. - F Geisingen K i r c h e n - H a u s e n (Lkr. Tuttlingen). Fdst. 2. 1 M 1 : 4; 2 M 1 : 2. - G Hartheim F e l d k i r c h (Kr. Breisgau-Hochschwarzwald). M 1 : 3.

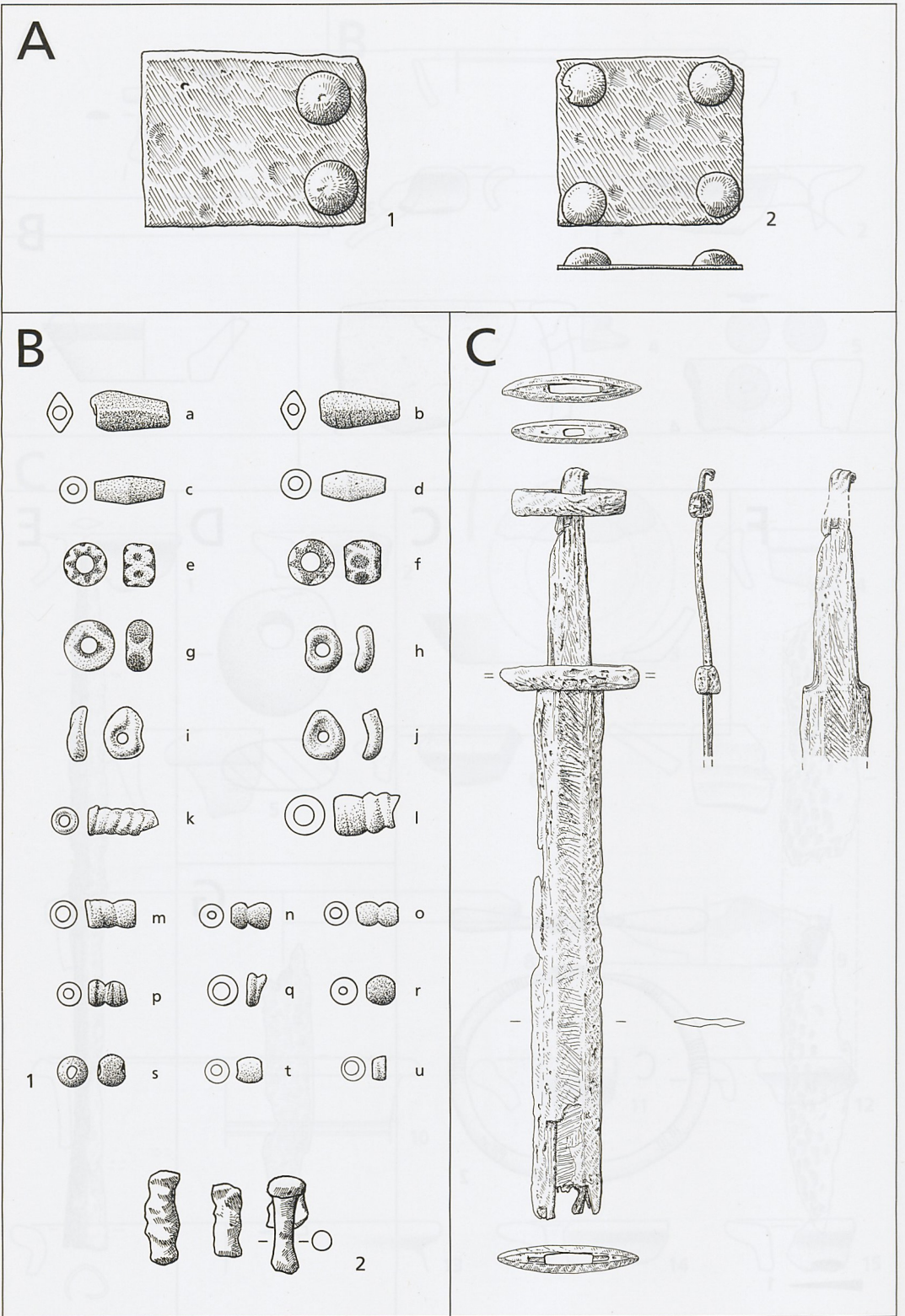

A March Hugstetten (Kr. Breisgau-Hochschwarzwald). M 1 : 2. - B Pfaffenweiler Öhlin-sweiler (Kr. Breisgau-Hochschwarzwald). M 1 : 1. - C Rheinmünster Stollhofen (Lkr. Rastatt). M 1 : 4.



Stühlingen Weizen (Lkr. Waldshut). M 1:4.

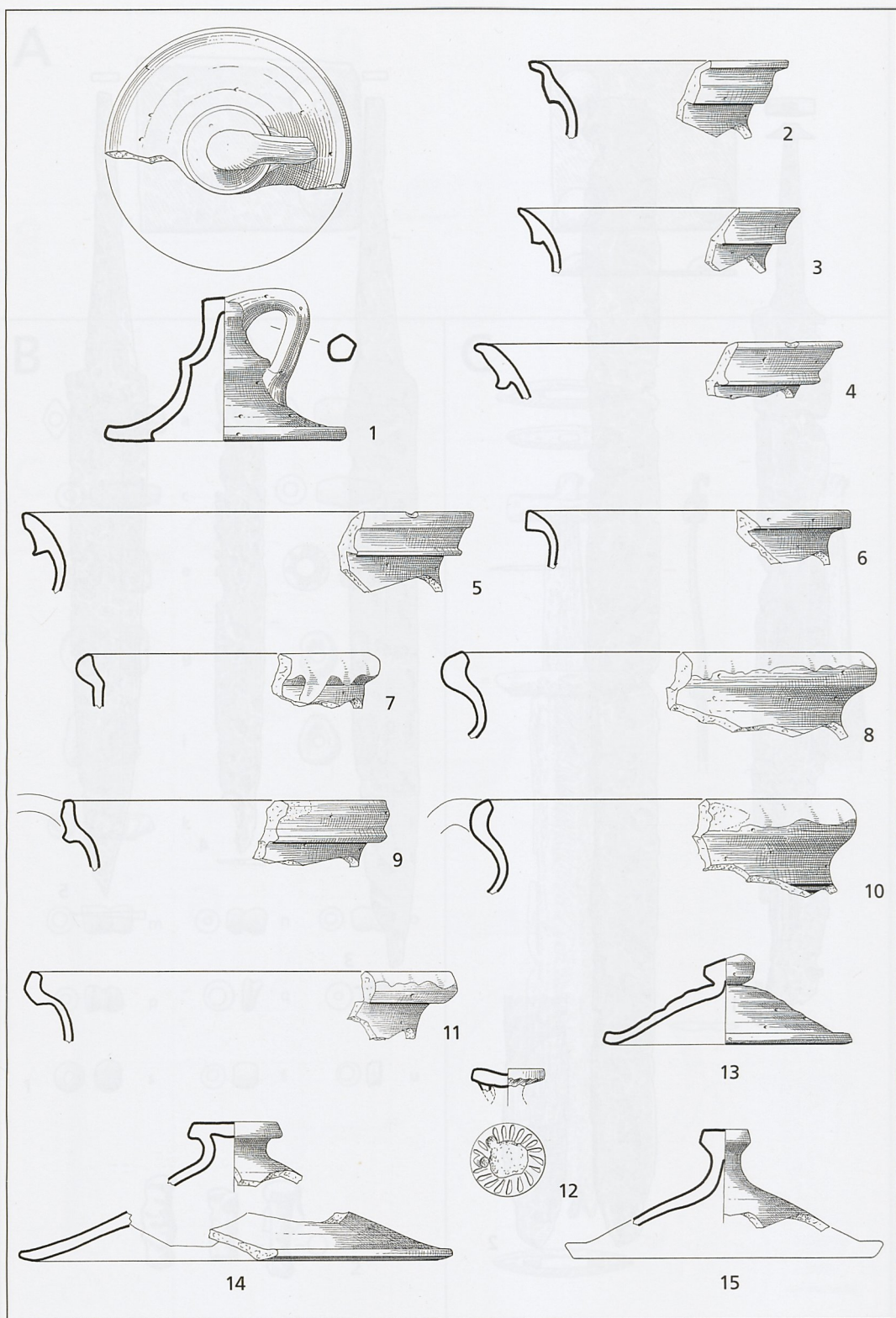

Backnang (Rems-Murr-Kreis). M 1 : 3.

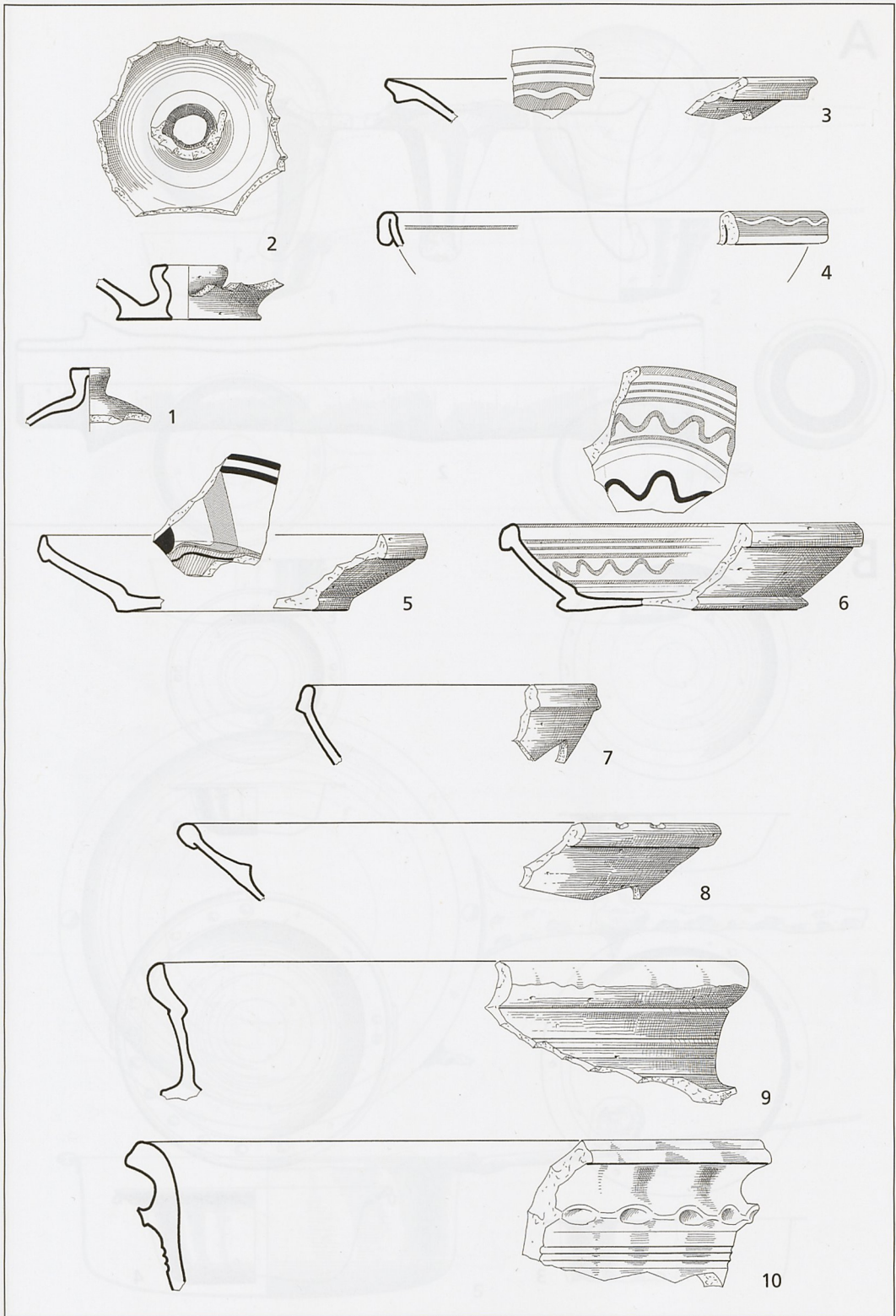

Backnang (Rems-Murr-Kreis). M 1 : 3.

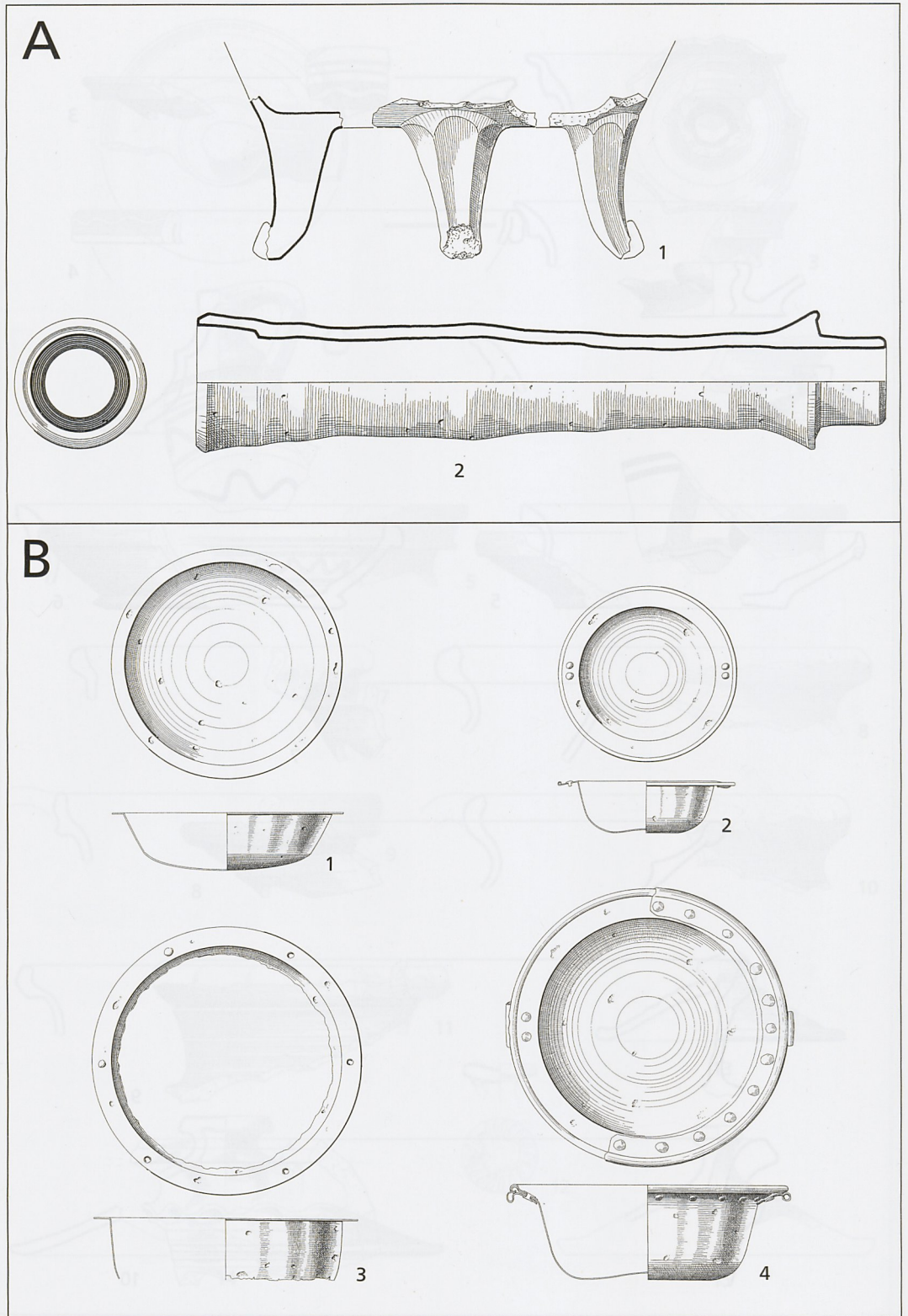

A Backnang (Rems-Murr-Kreis). M 1 : 3; 2 M 1 : 5. – B Baden-Baden. M 1 : 5.

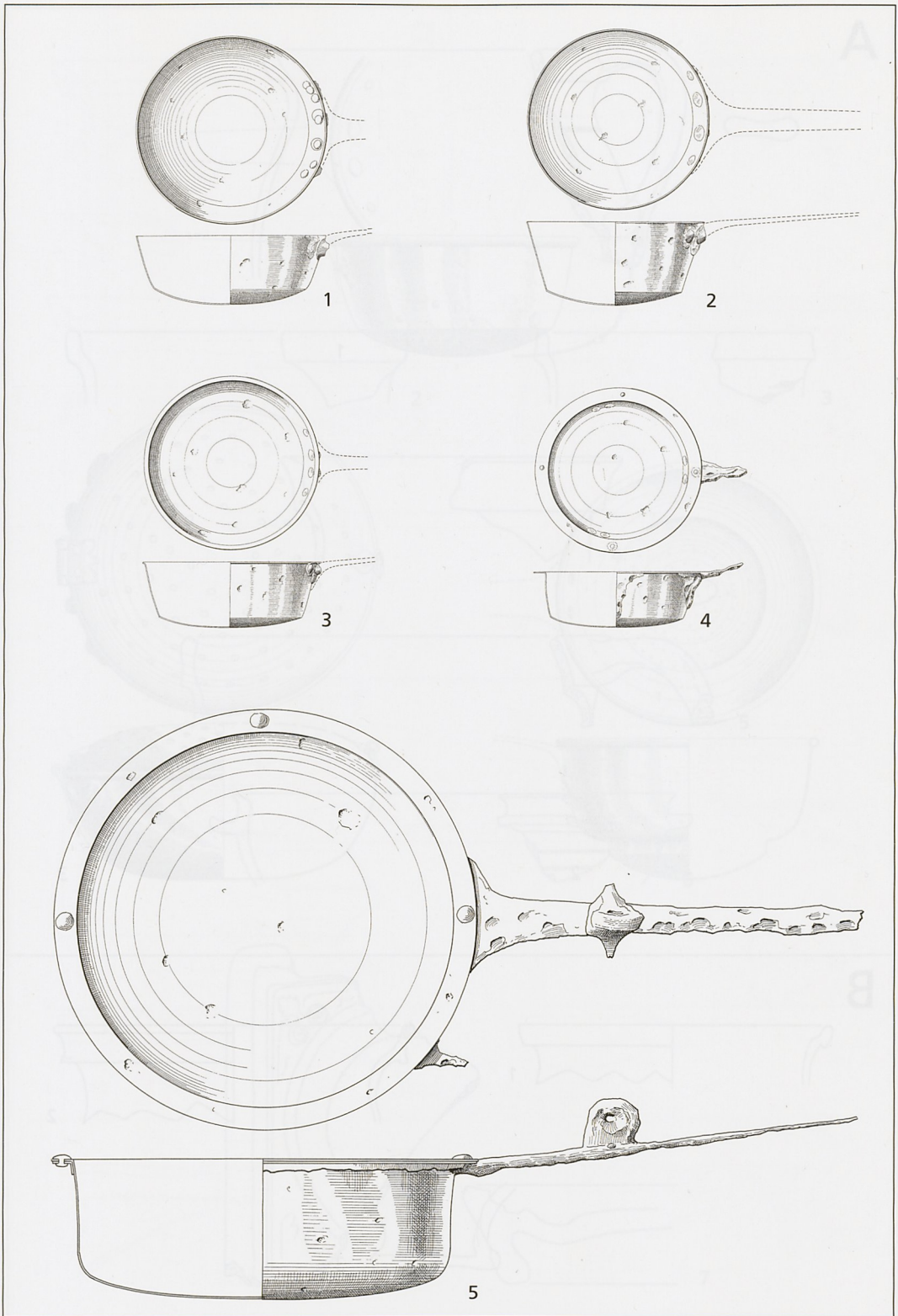

Baden-Baden. M 1 : 5; 5 M 1 : 6.

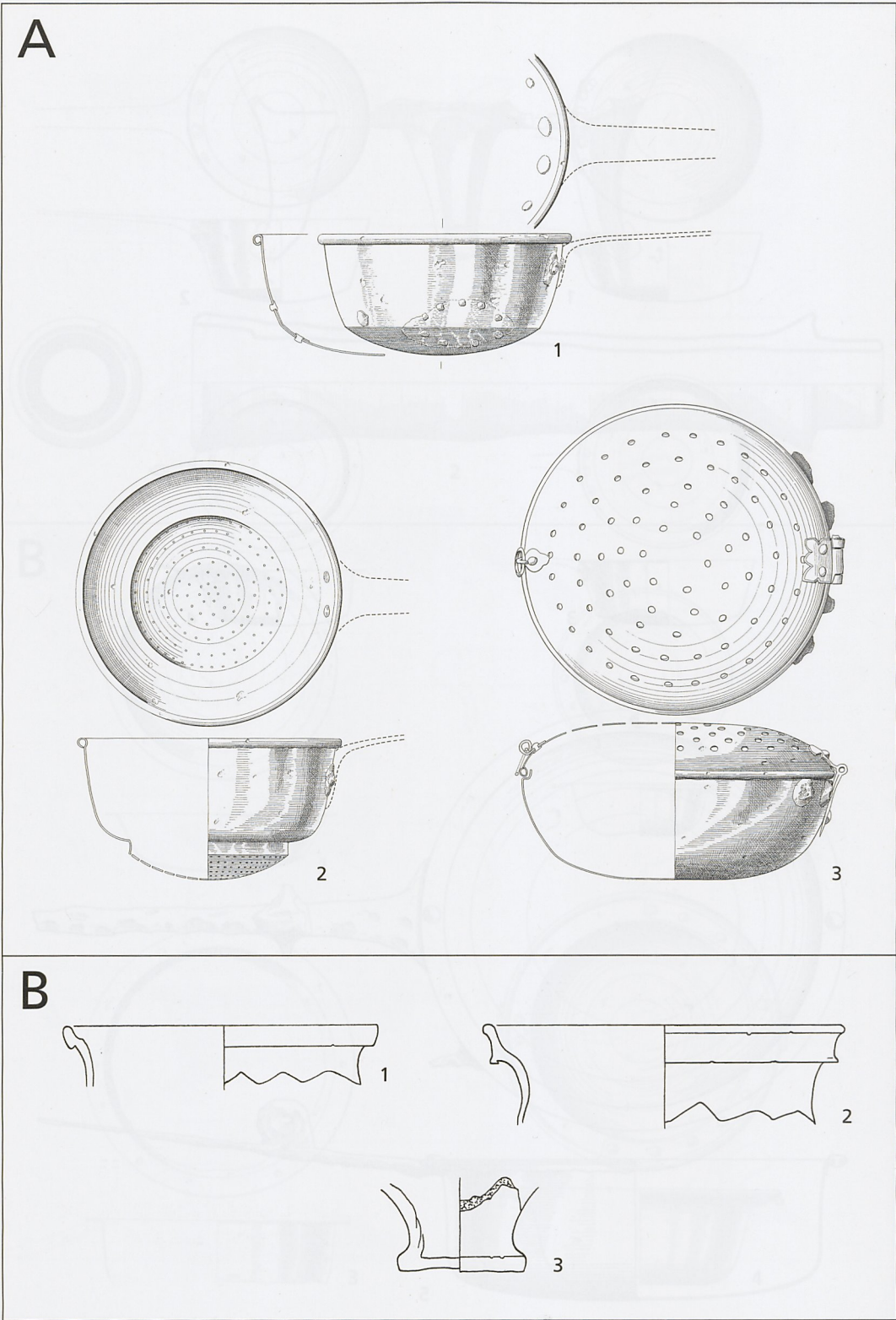

A Baden-Baden. M 1 : 5. - B Billigheim Allfeld (Neckar-Odenwald-Kreis). M 1 : 3.

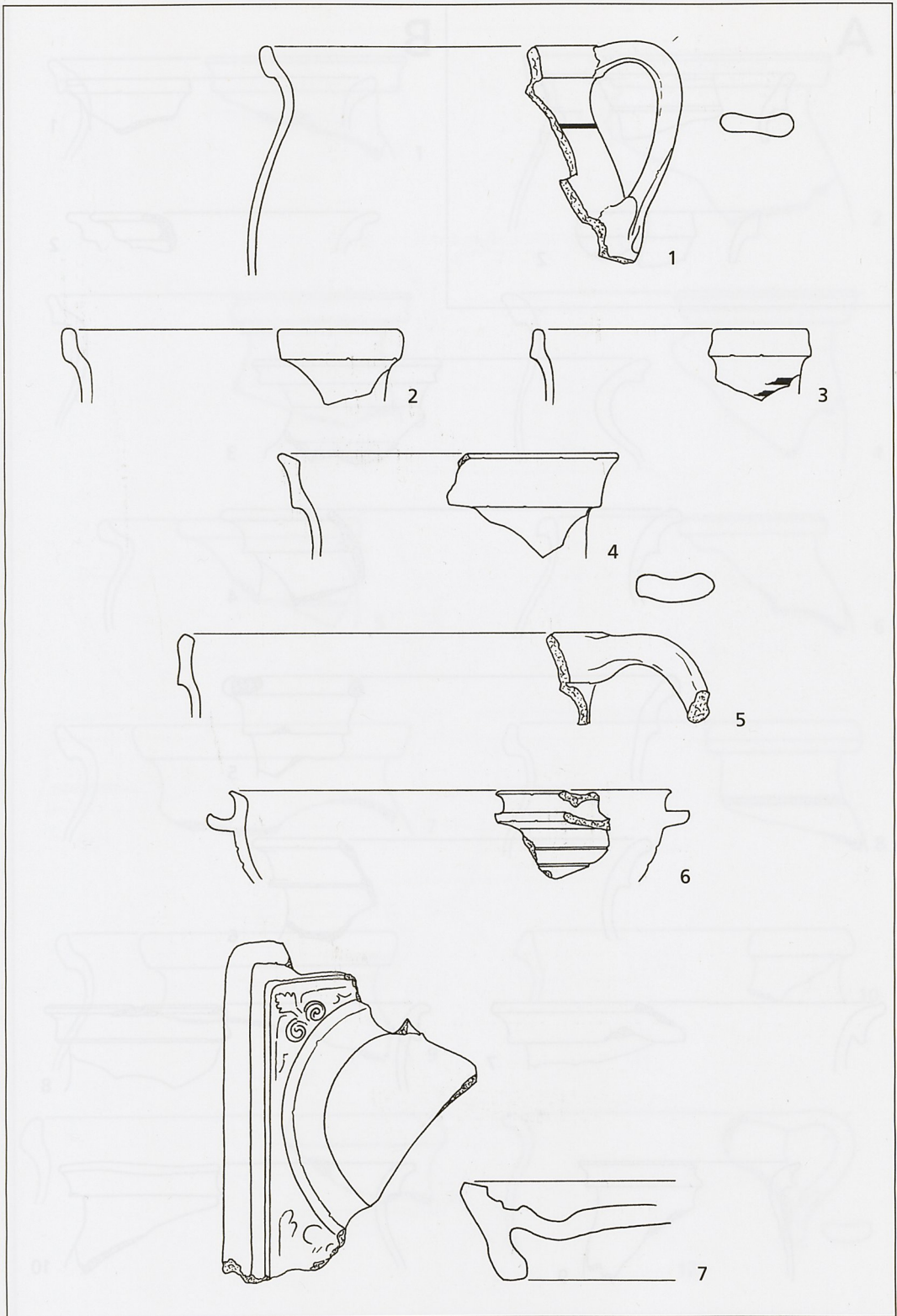

Bretten (Lkr. Karlsruhe). M 1 : 3.

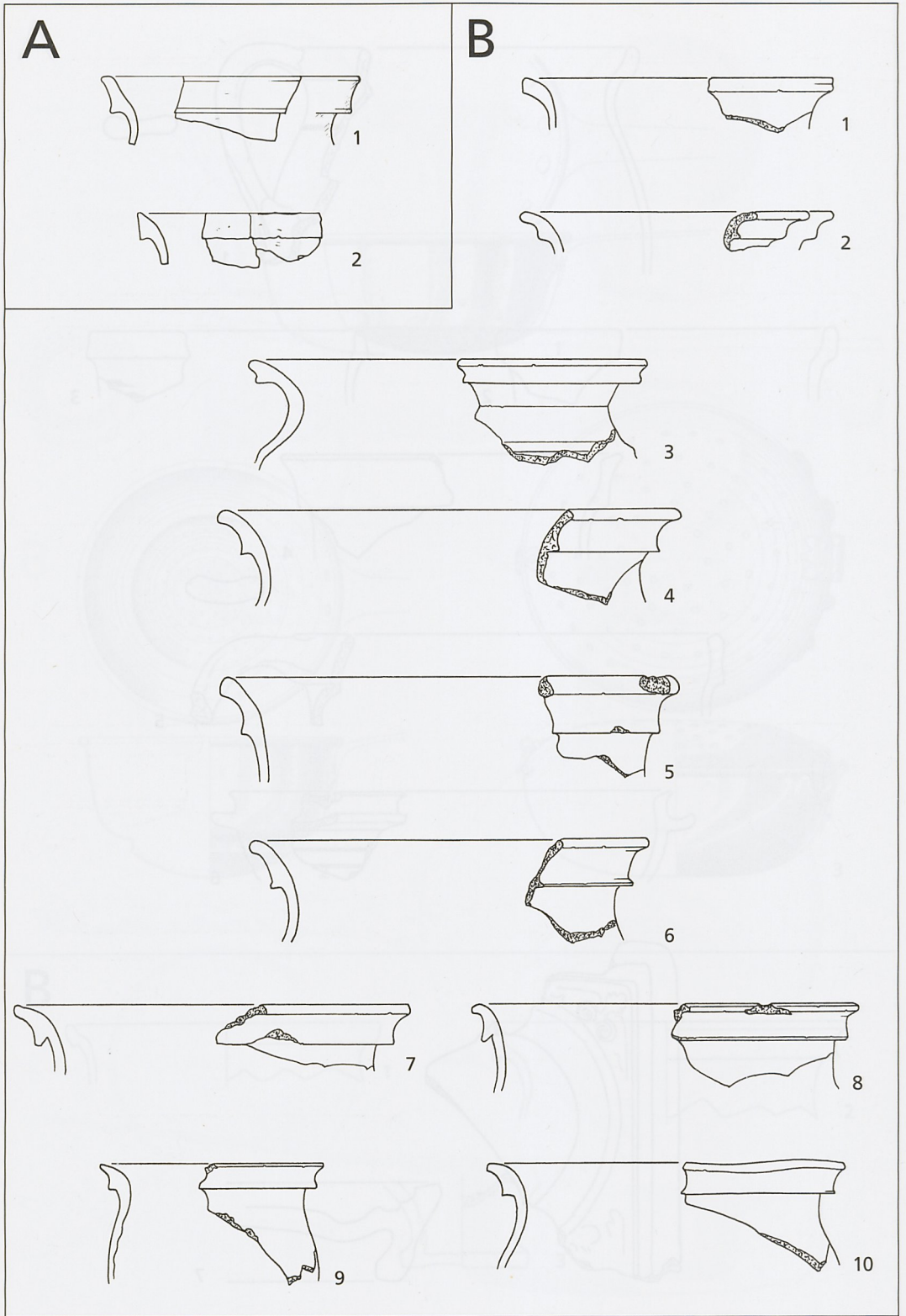

A Bühl (Lkr. Rastatt). M 1 : 3. – B Calw (Lkr. Calw). M 1 : 3.

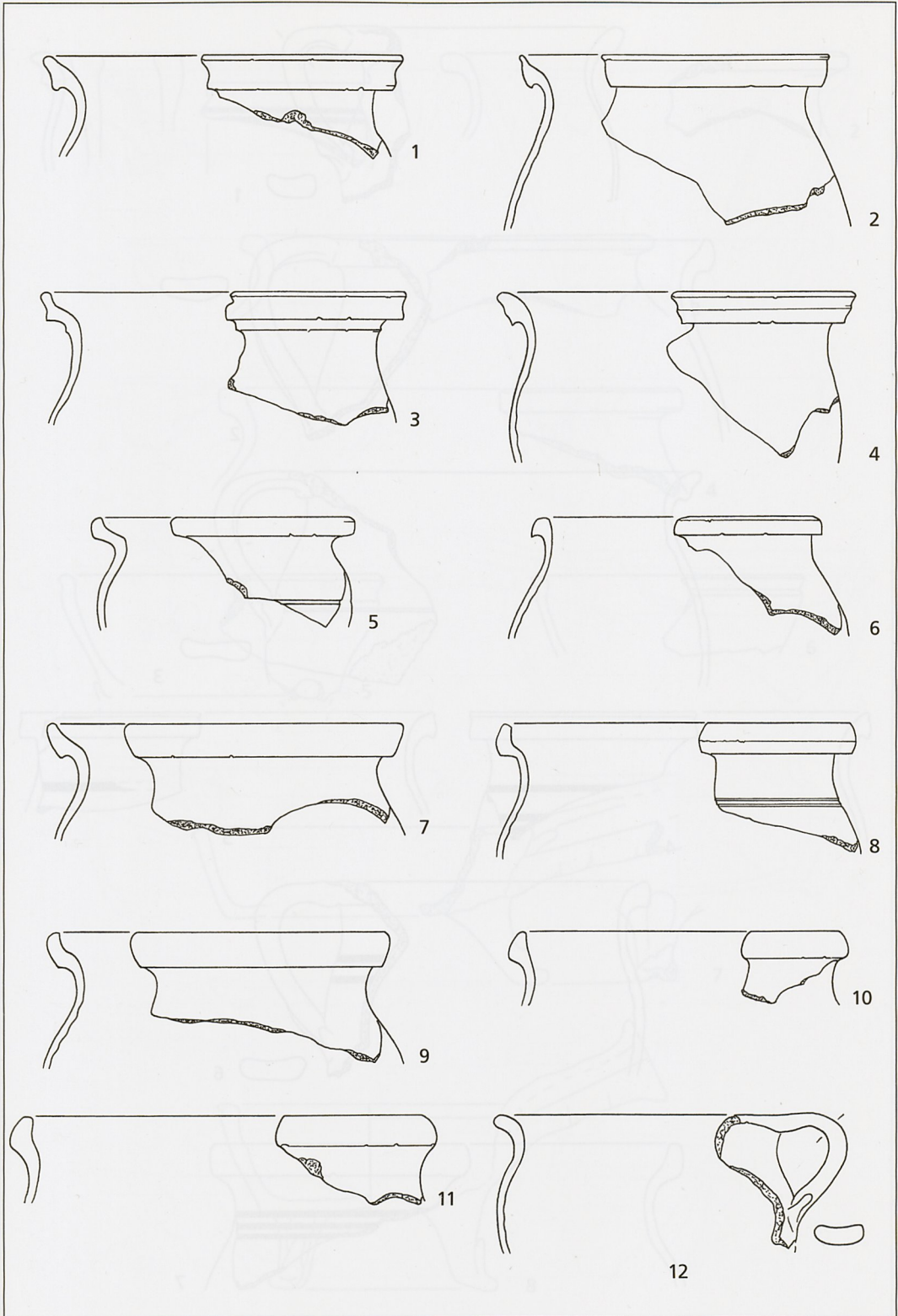

Calw (Lkr. Calw). M 1 : 3.

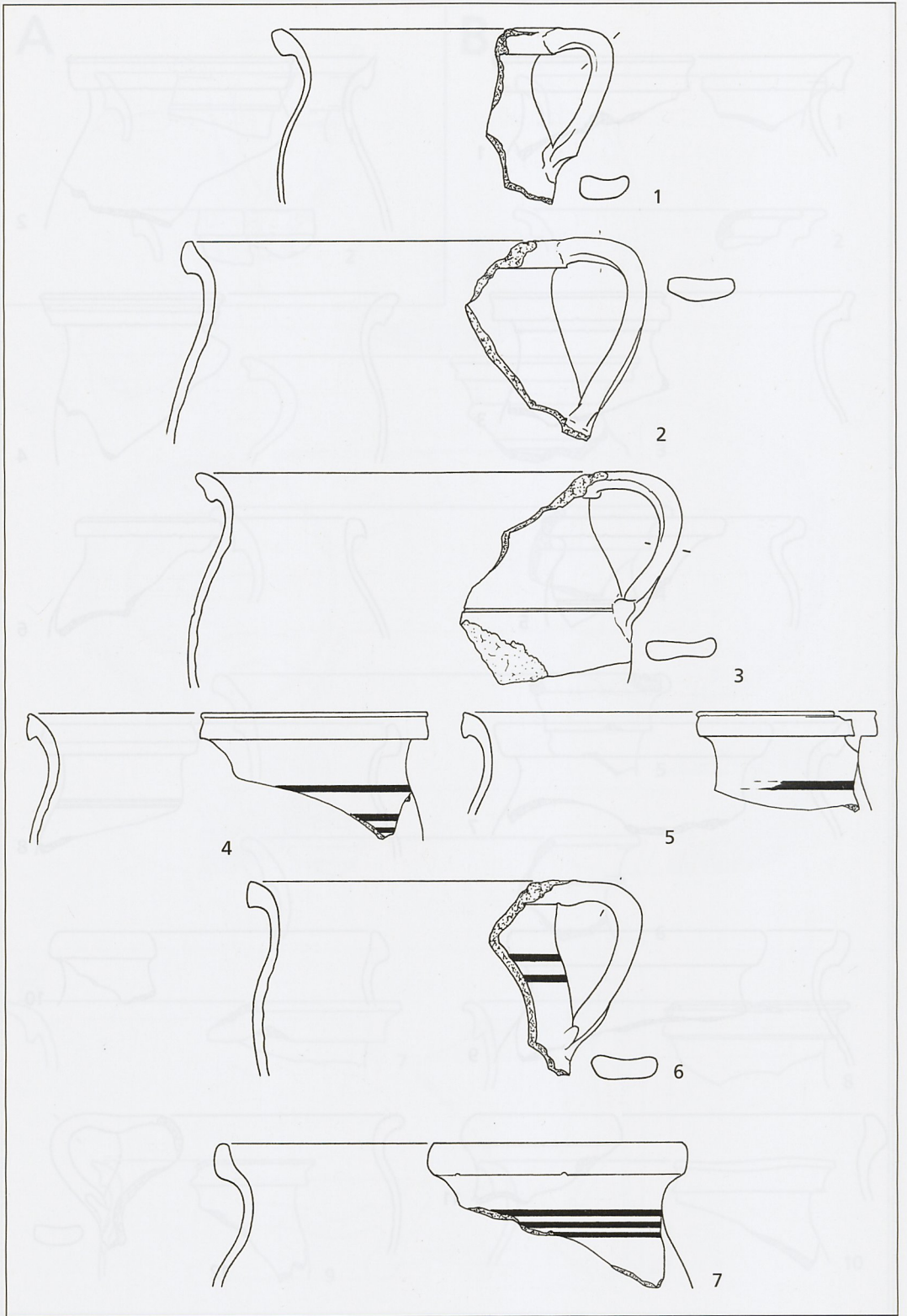

Calw (Lkr. Calw). M 1 : 3.

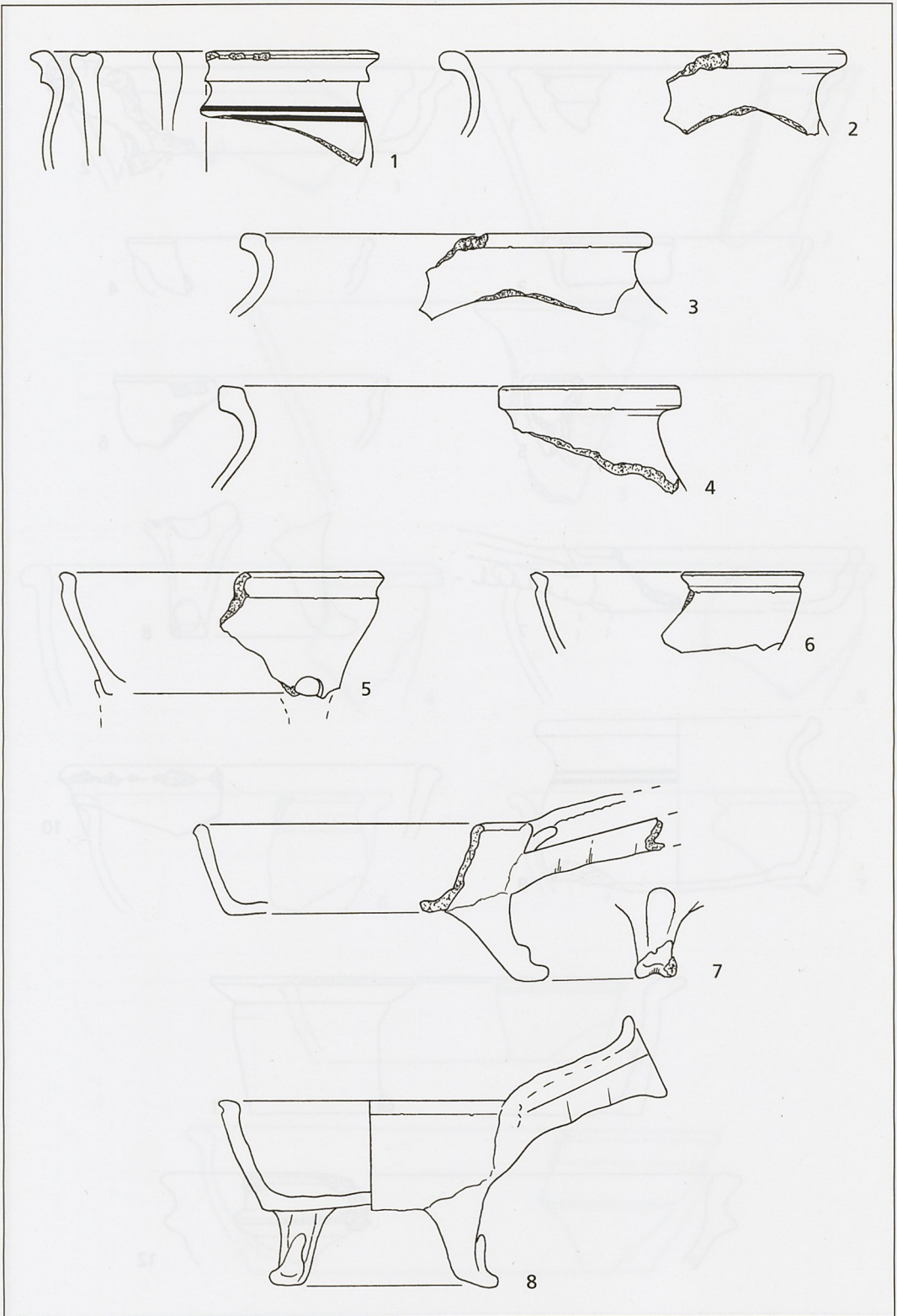

Calw (Lkr. Calw). M 1 : 3.

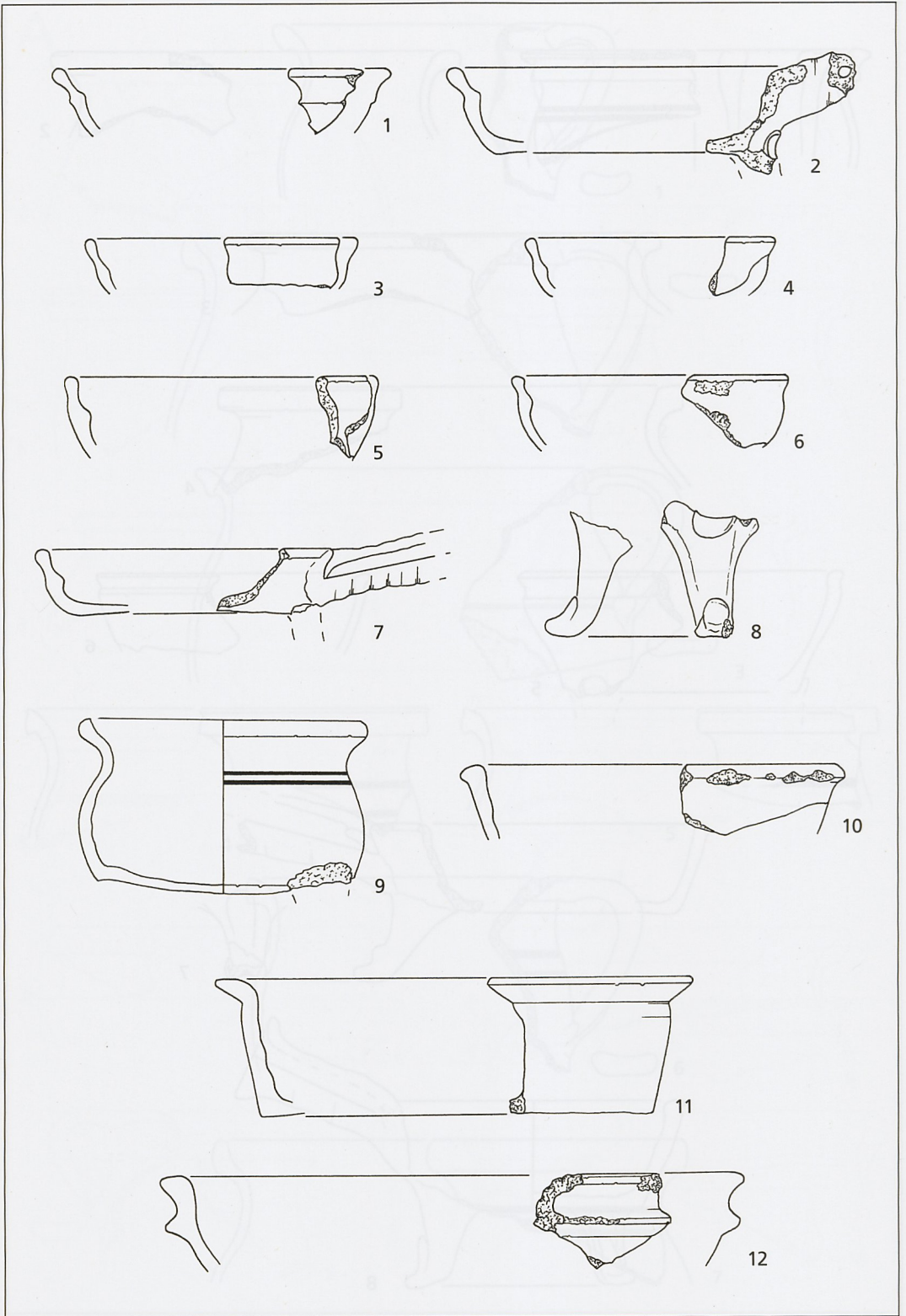

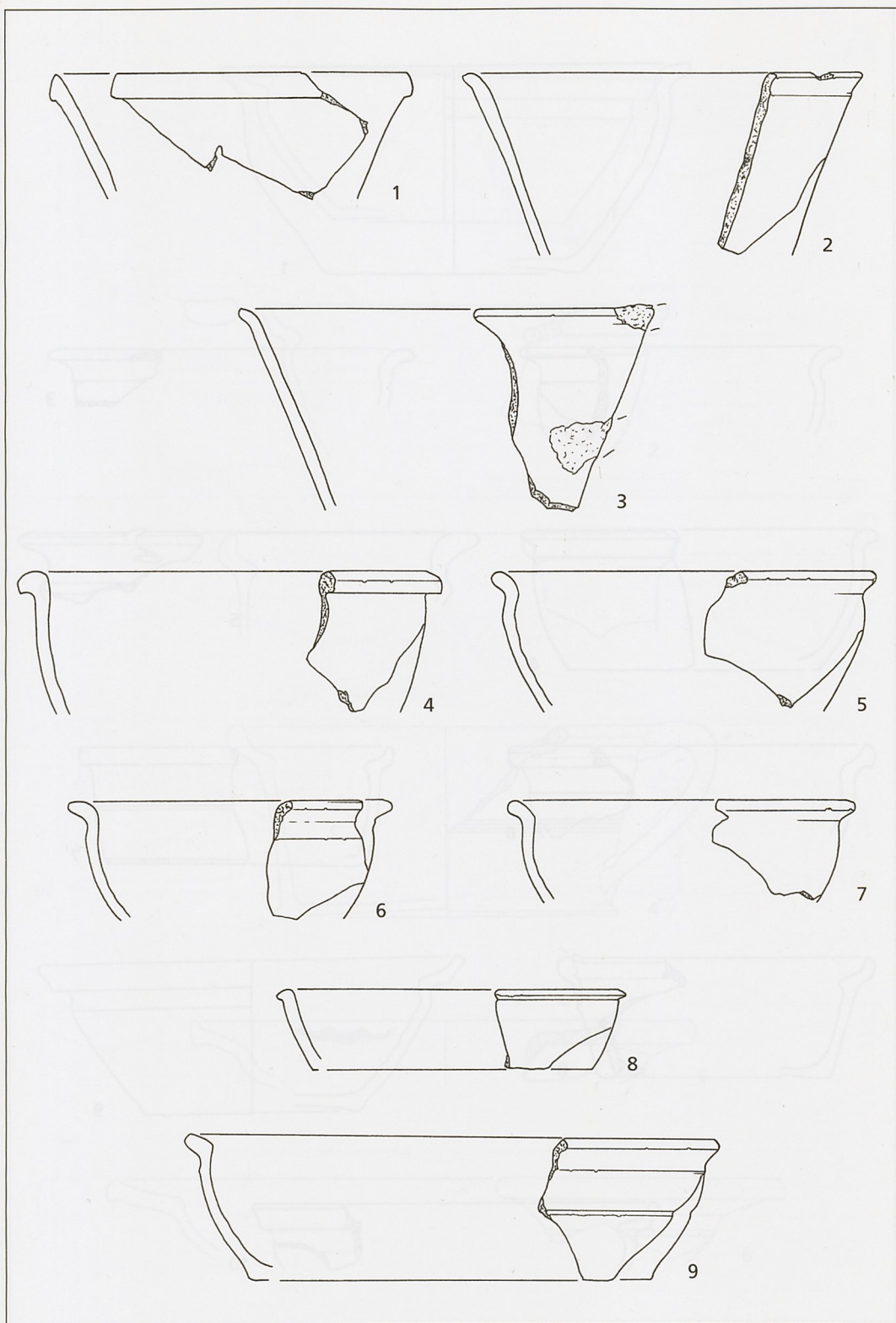

Calw (Lkr. Calw). M 1 : 3.

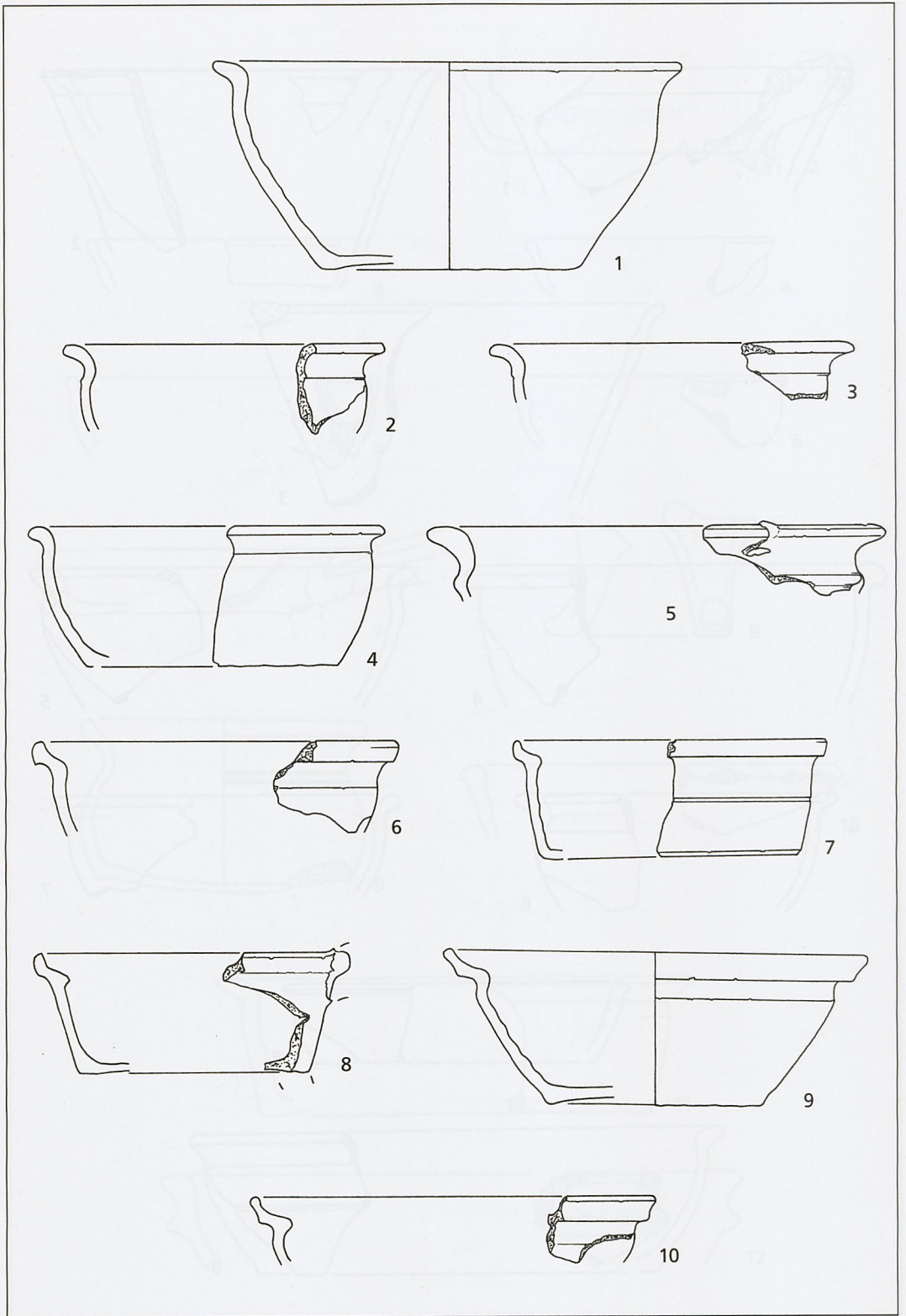

Calw (Lkr. Calw). M 1 : 3.

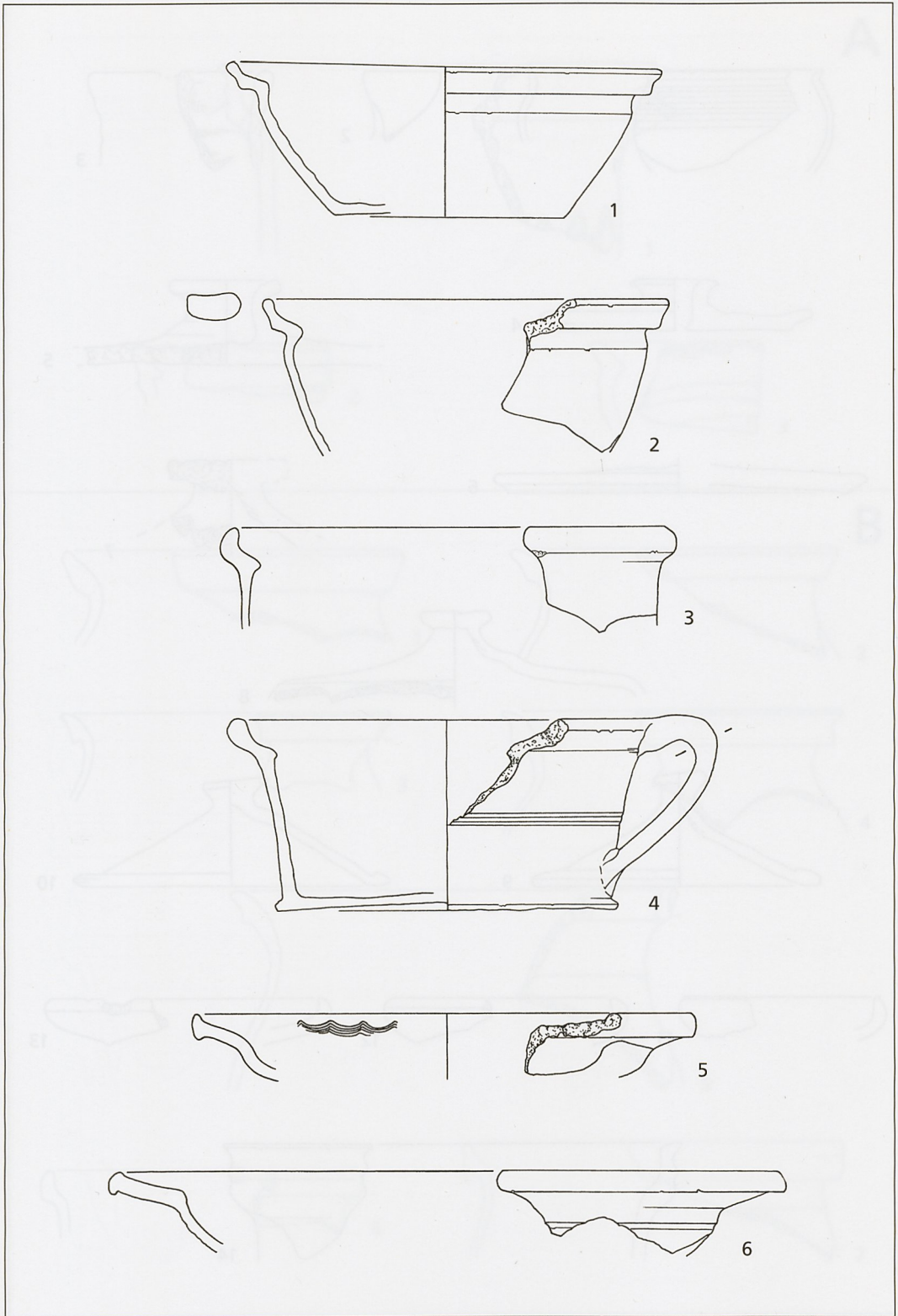

Calw (Lkr. Calw). M 1 : 3.

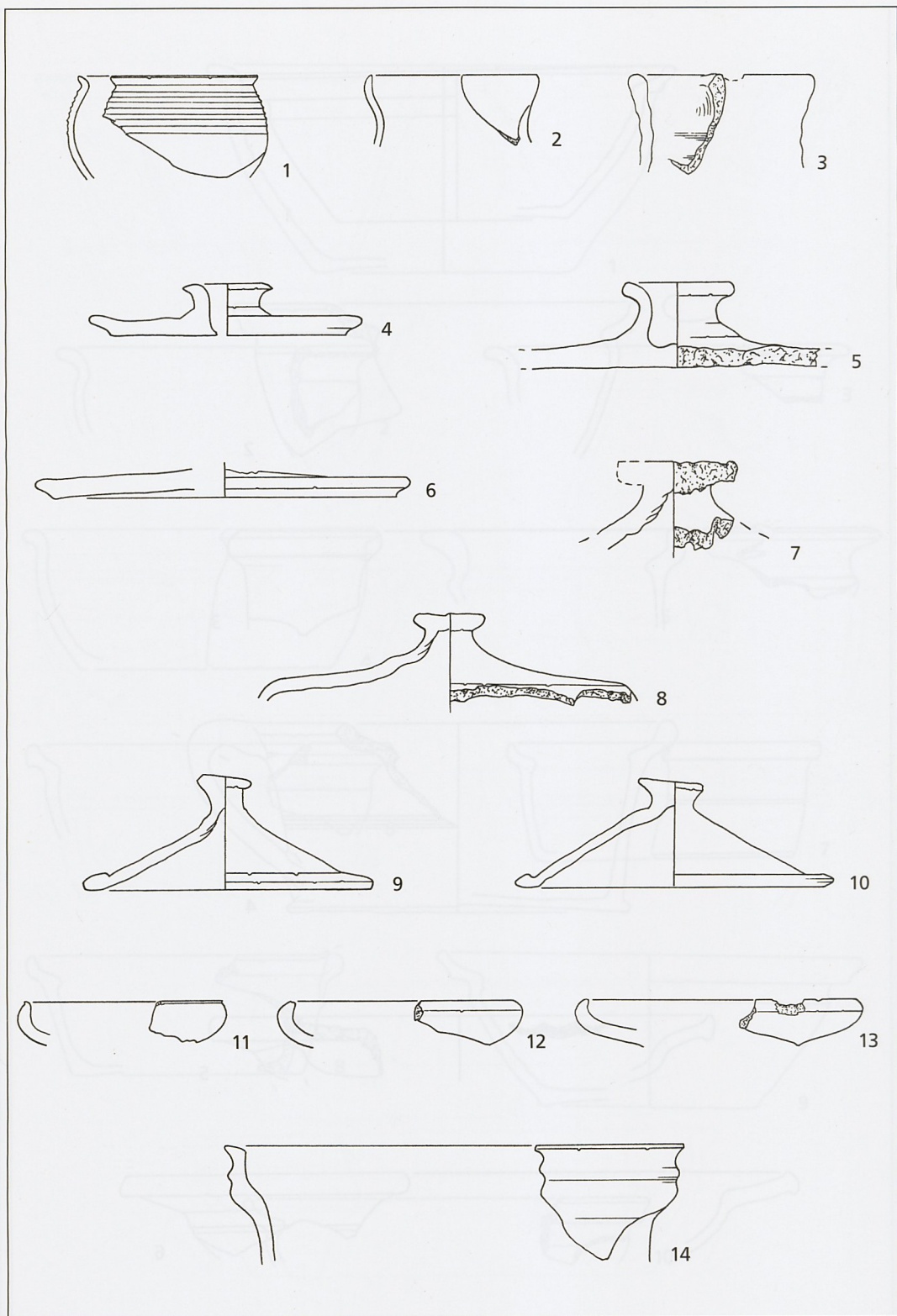

Calw (Lkr. Calw). M 1 : 3.

A

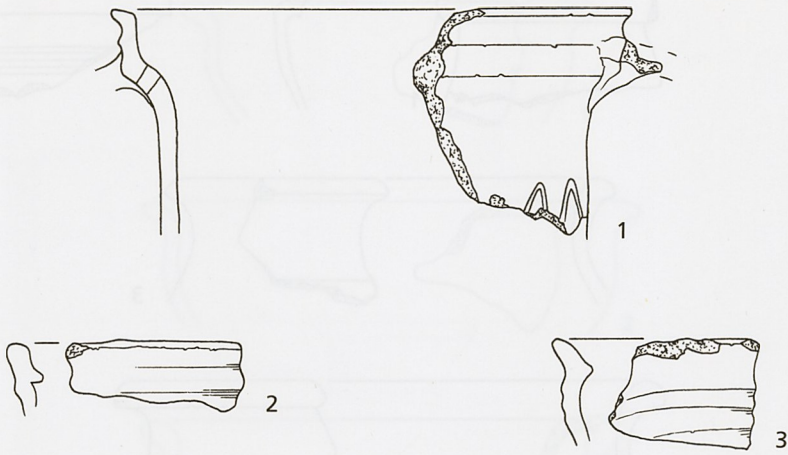

B

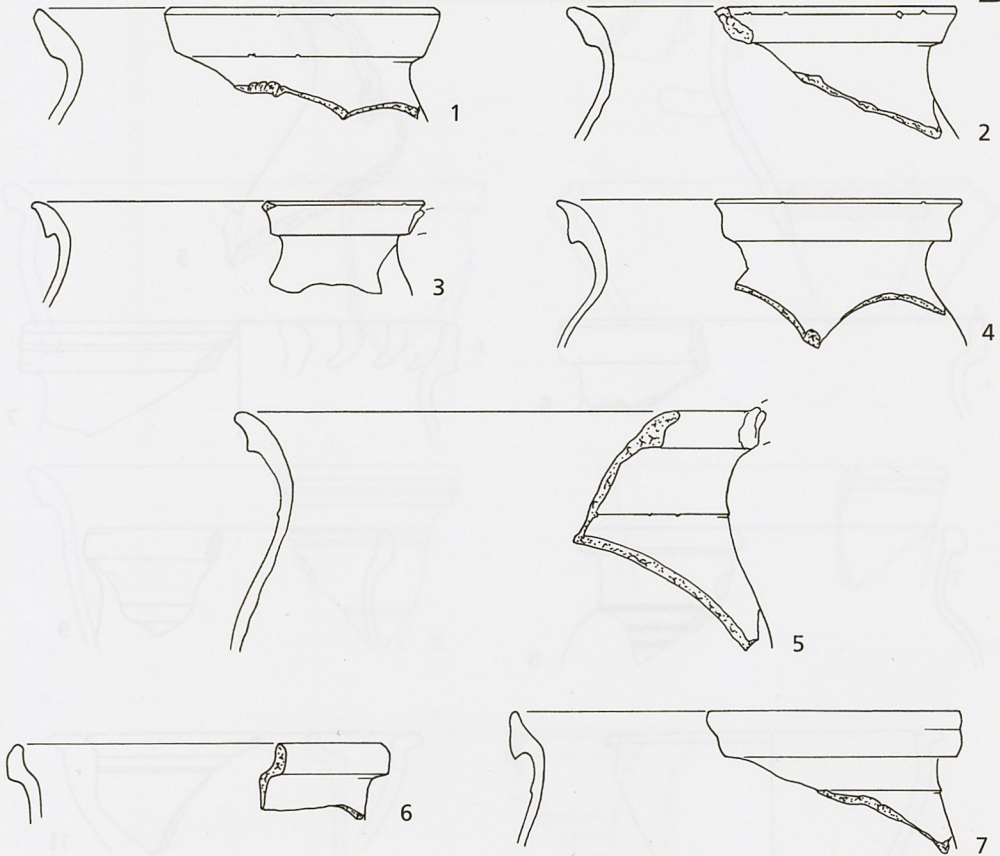

A Calw (Lkr. Calw). M 1 : 3. - B Calw Hirsau (Lkr. Calw). M 1 : 3.

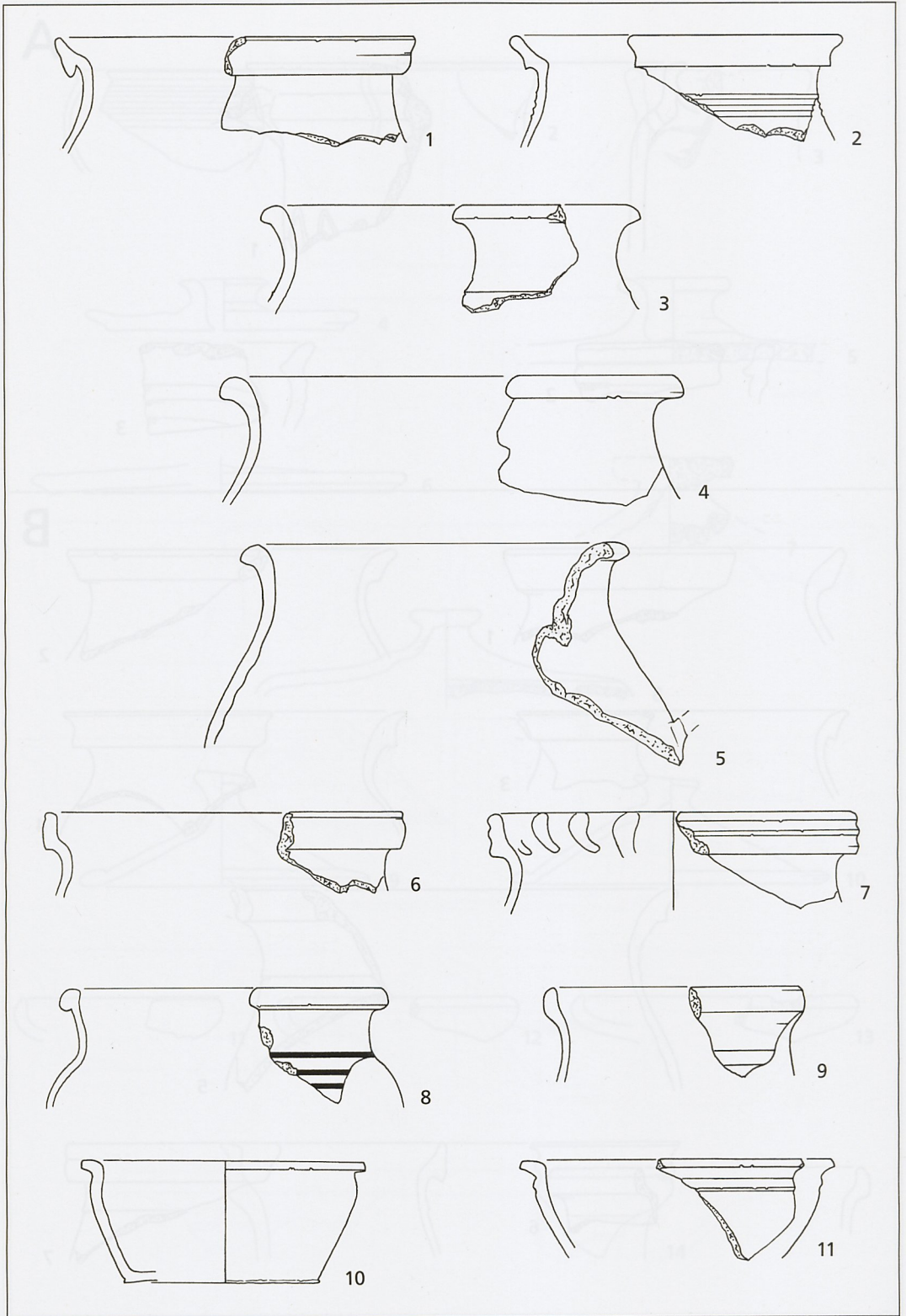

Calw Hirsau (Lkr. Calw). M 1:3.

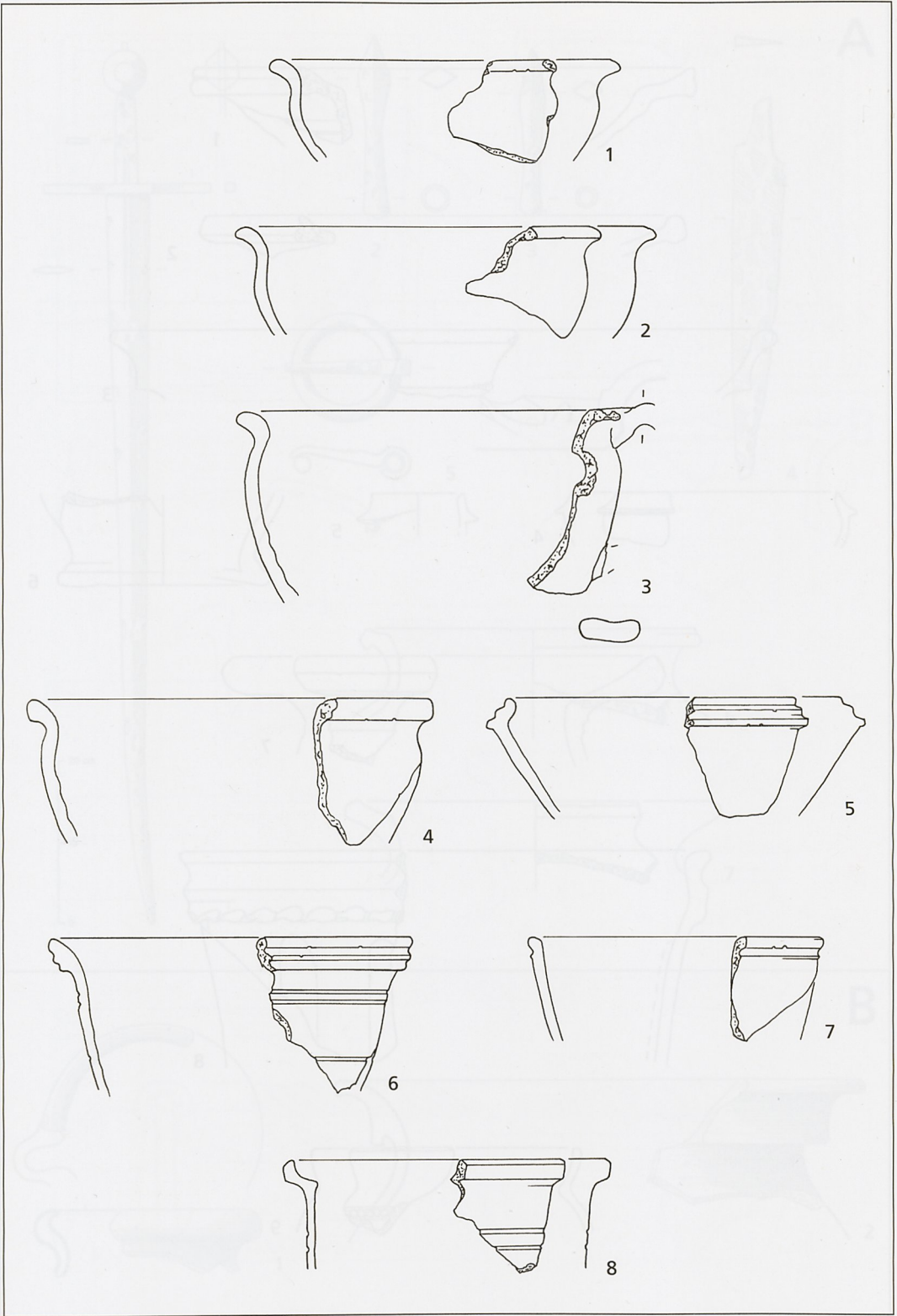

Calw Hirsau (Lkr. Calw). M 1:3.

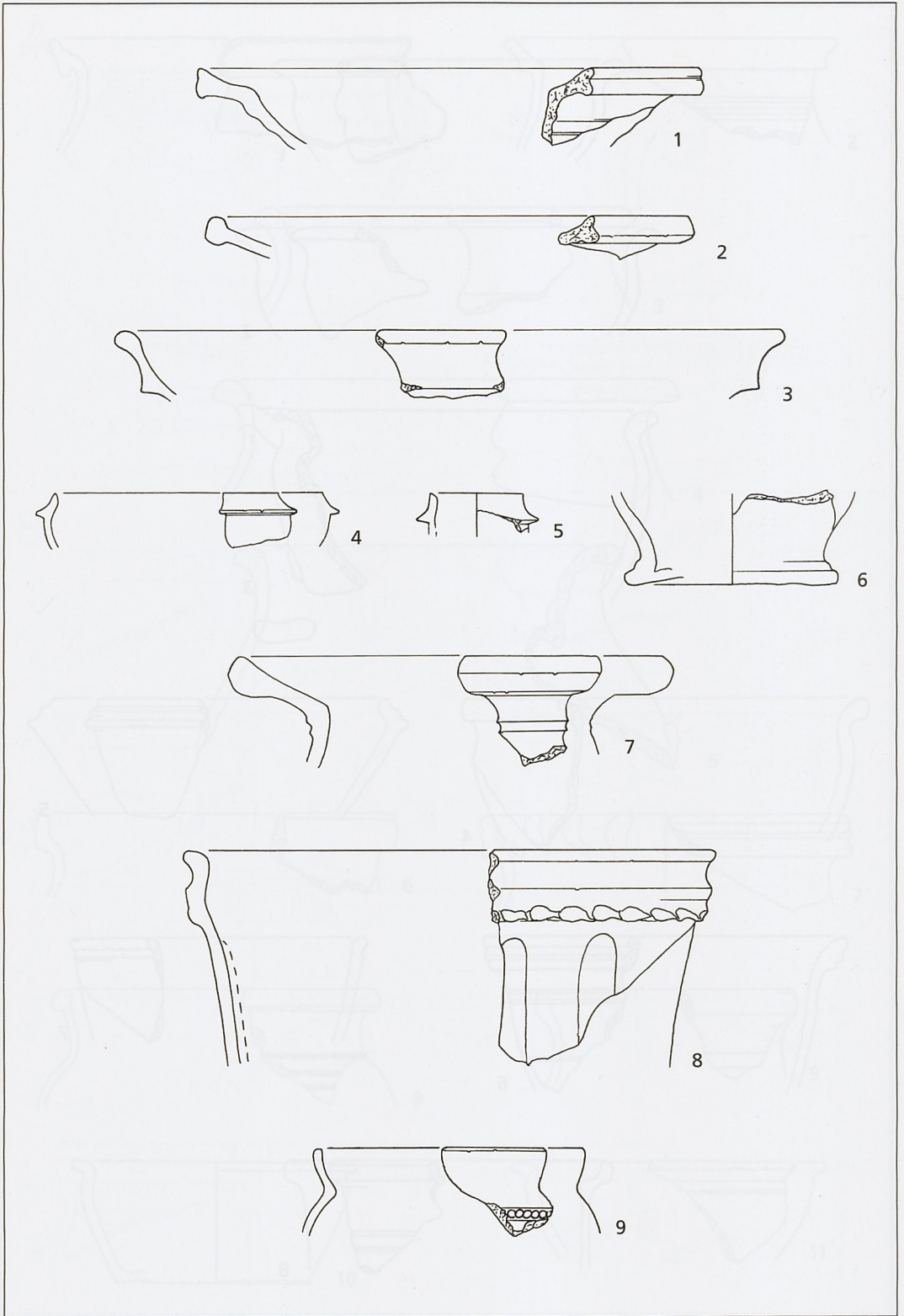

Calw Hirsau (Lkr. Calw). M 1:3.

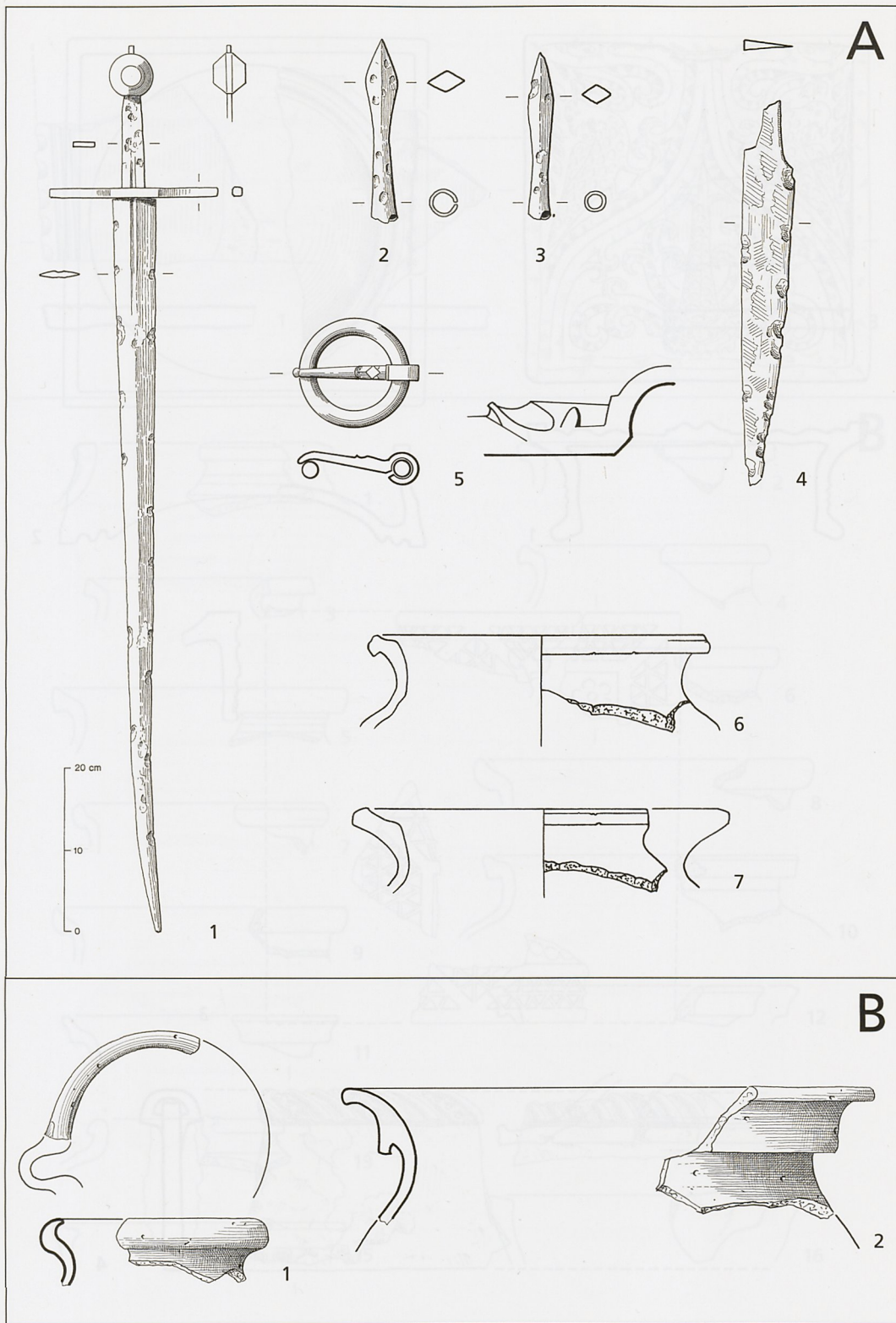

A Deizisau (Lkr. Esslingen). M 1 : 3; 1 M 1 : 8. – B Denkendorf (Lkr. Esslingen). Fdst. 1. M 1 : 3.

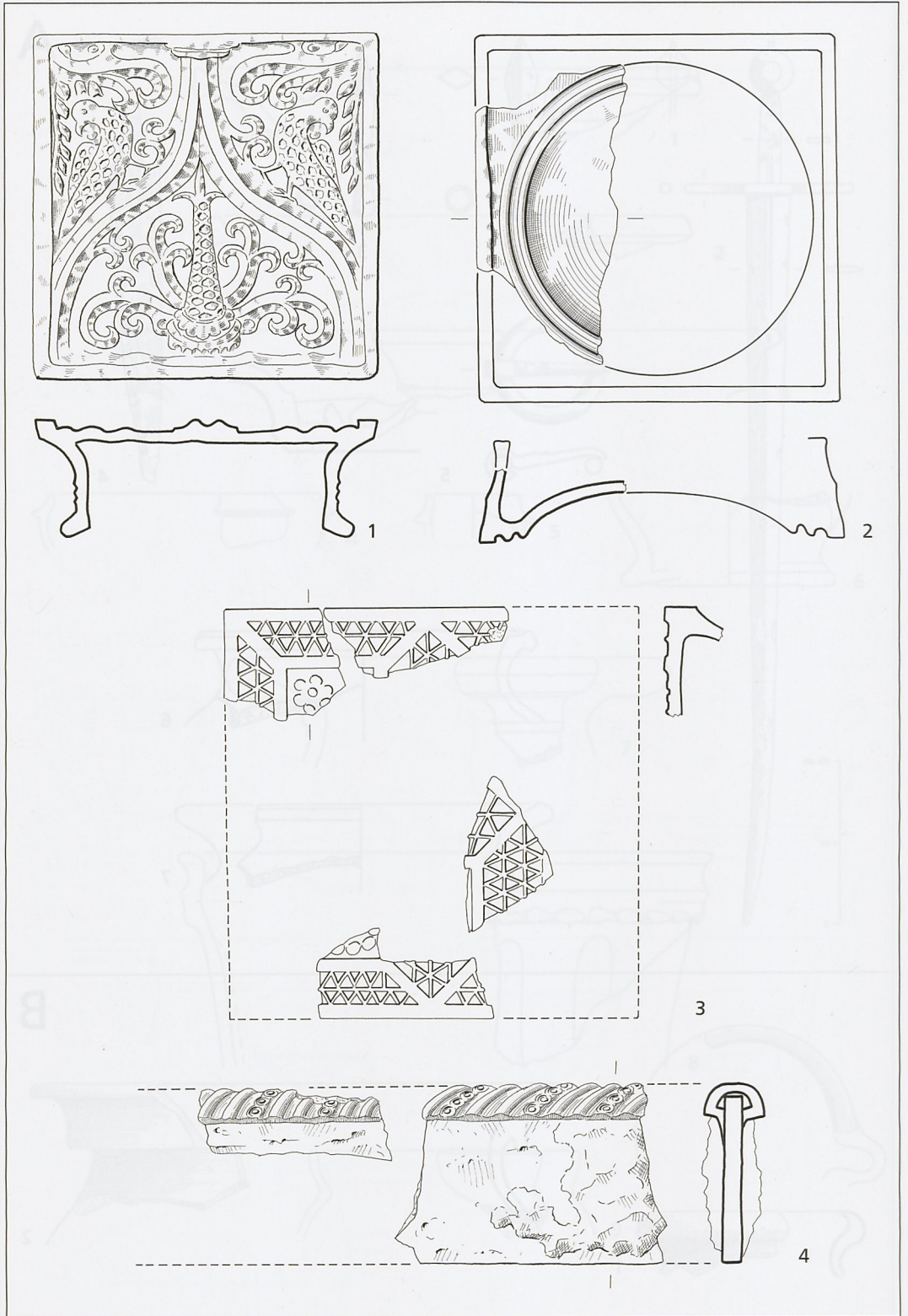

Denkendorf (Lkr. Esslingen). Fdst. 1. M 1 : 3.

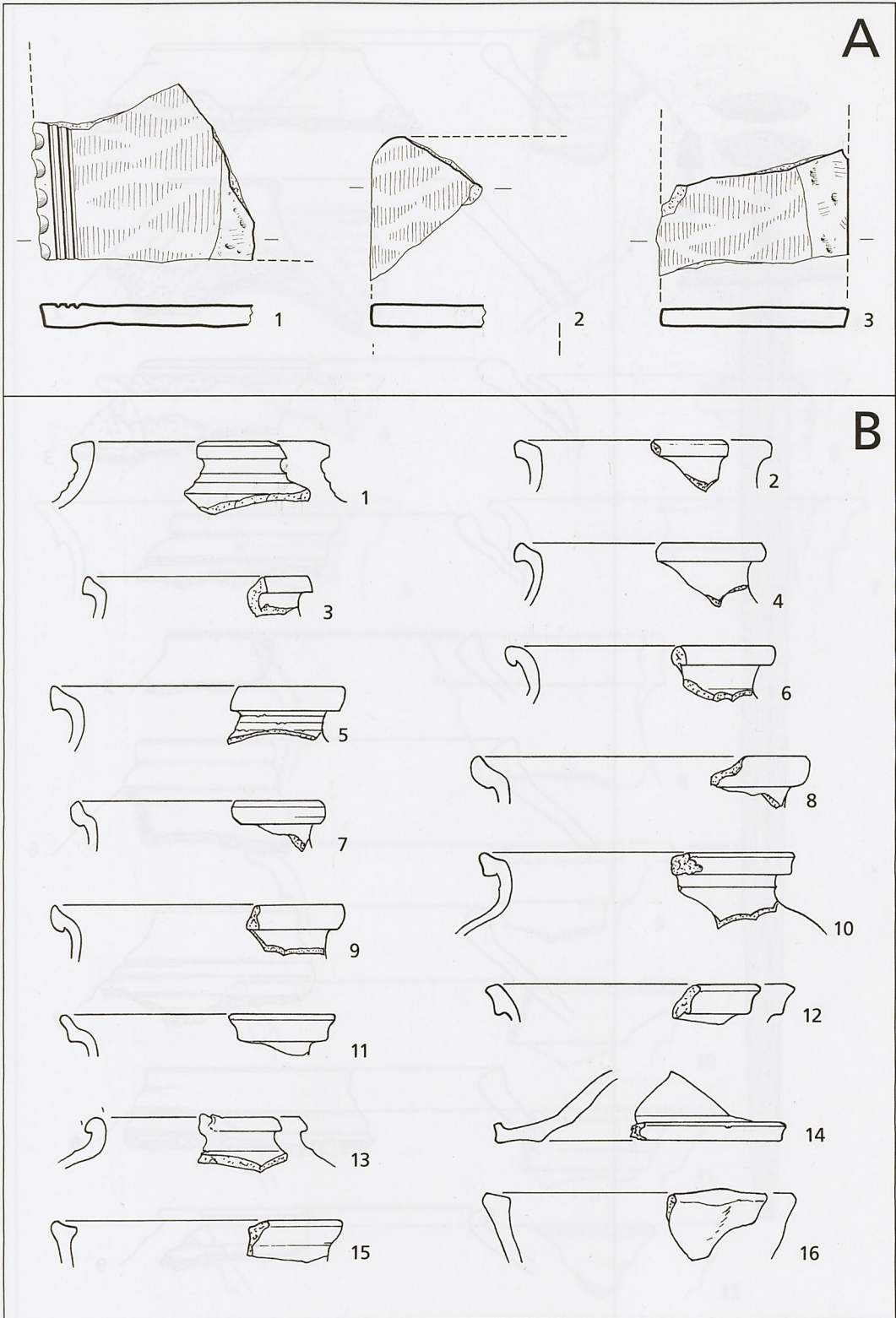

A Denkendorf (Lkr. Esslingen). Fdst. 1. M 1 : 3. – B Eberbach (Rhein-Neckar-Kreis). M 1 : 3.

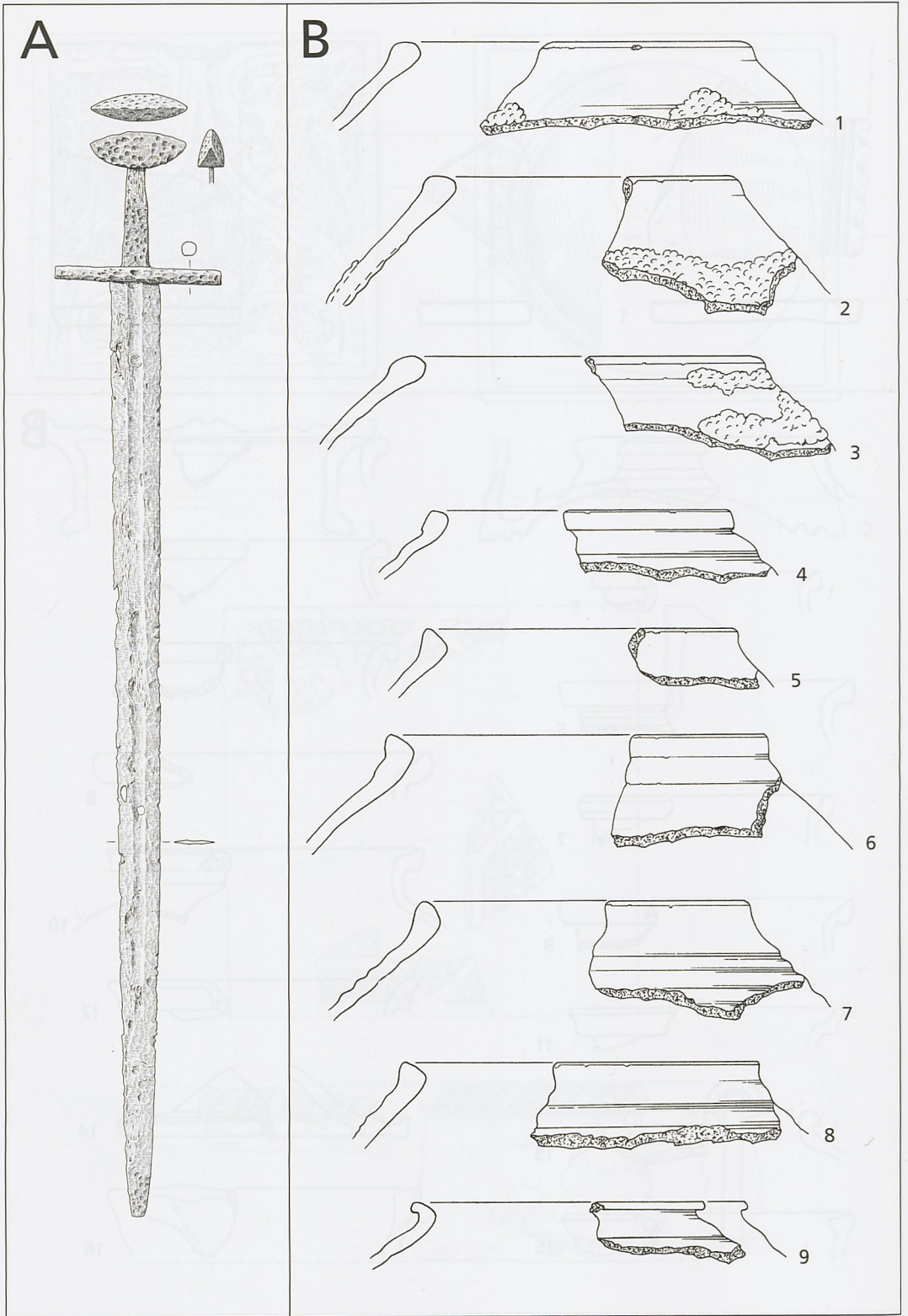

A Efringen-Kirchen Kleinkems (Lkr. Lörrach). M 1:6. -
B Ellwangen Stocken (Ostalbkreis). M 1:3.

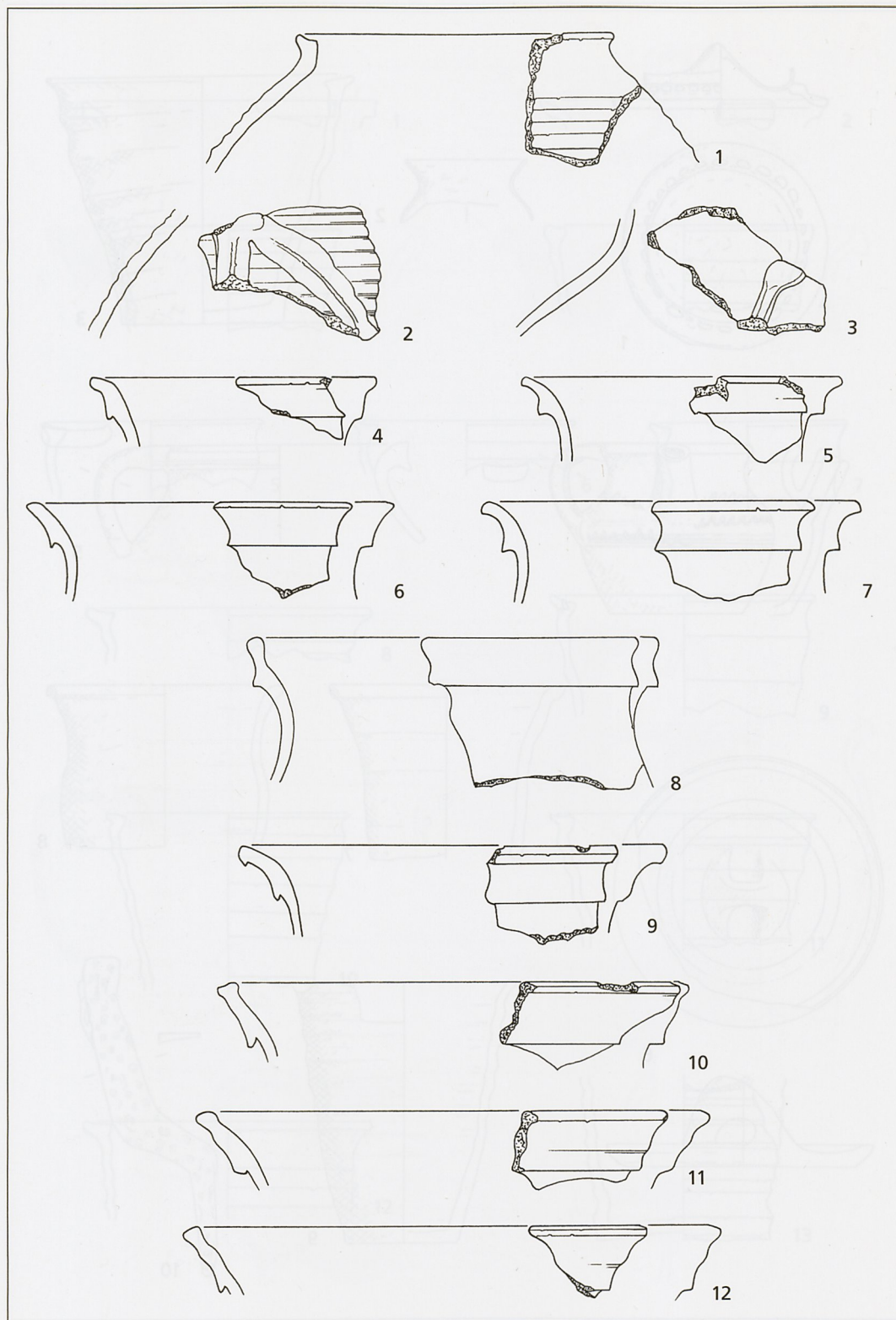

Ellwangen Stocken (Ostalbkreis). M 1 : 3.

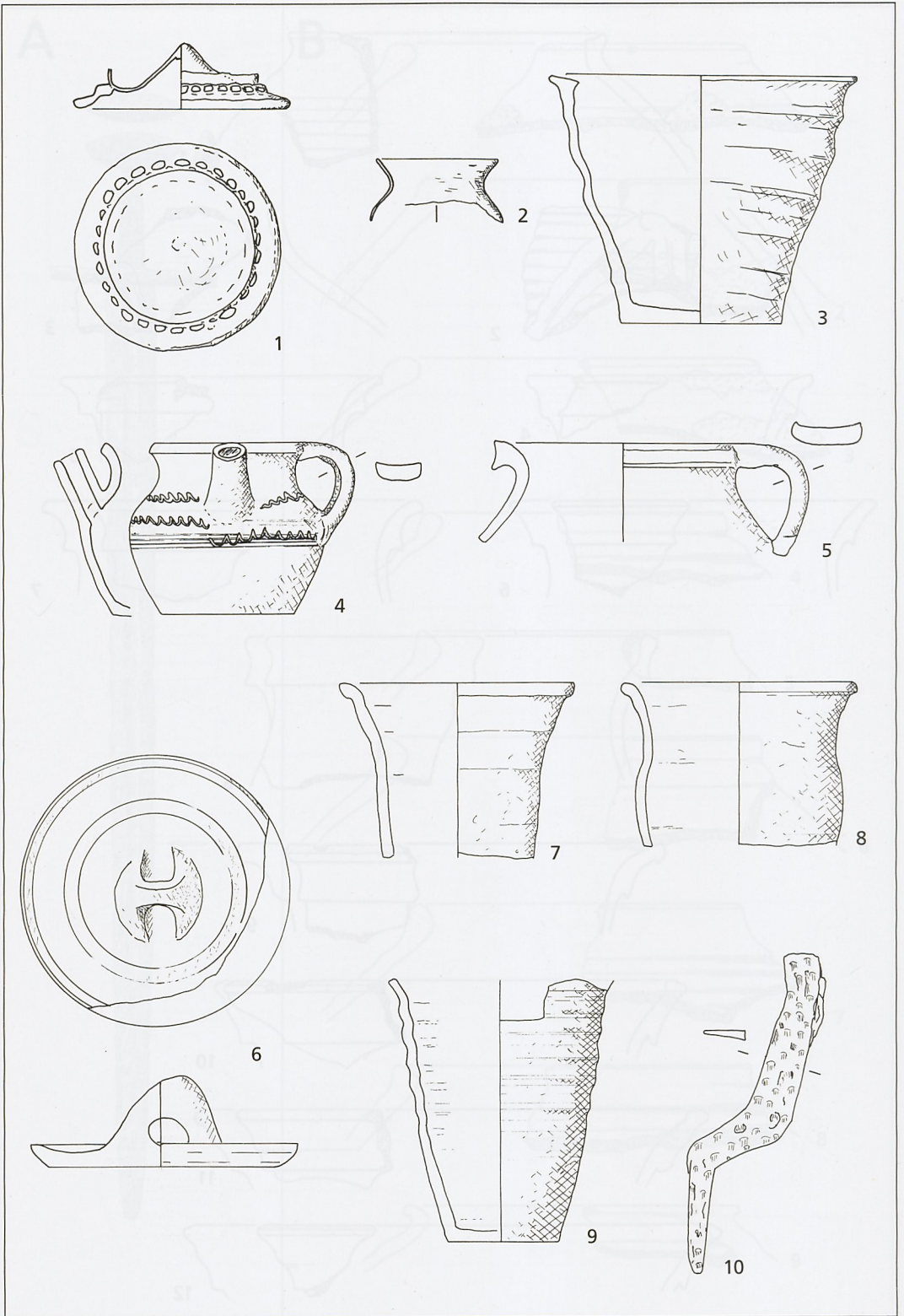

Endingen am Kaiserstuhl (Lkr. Emmendingen). 1-3 Fdst. 1; 4-10 Fdst. 3. M 1 : 3.

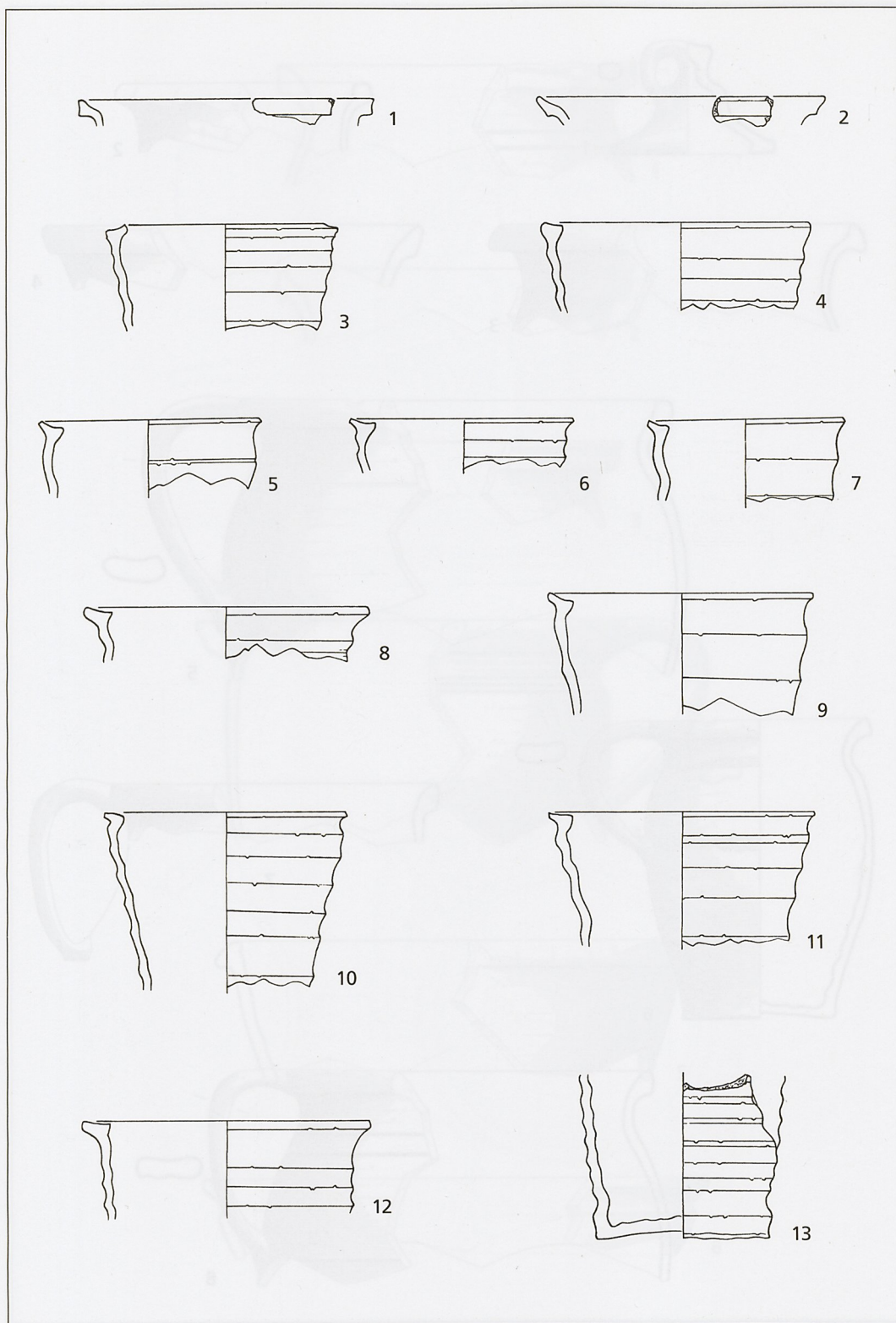

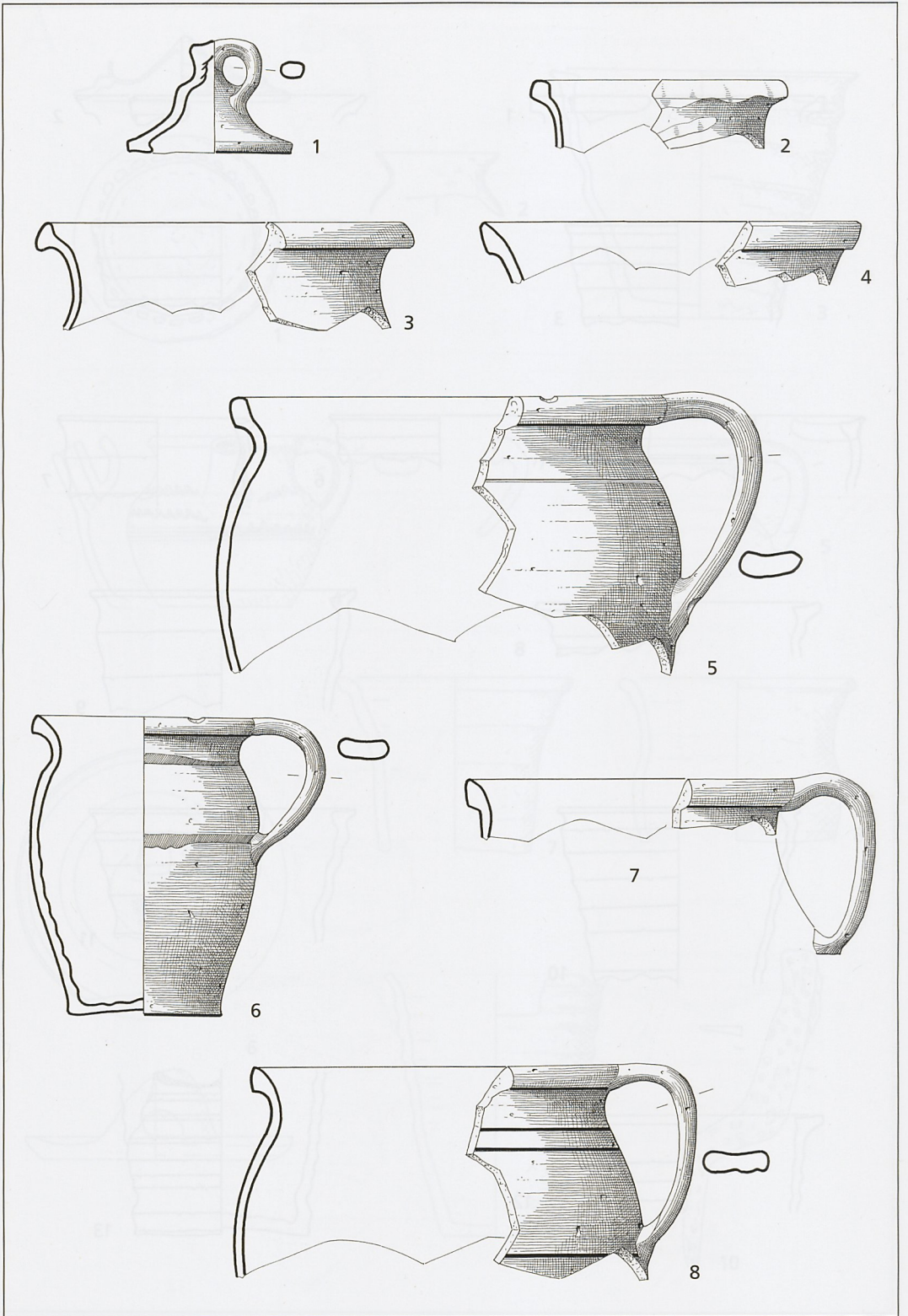

Esslingen am Neckar (Lkr. Esslingen). M 1 : 3.

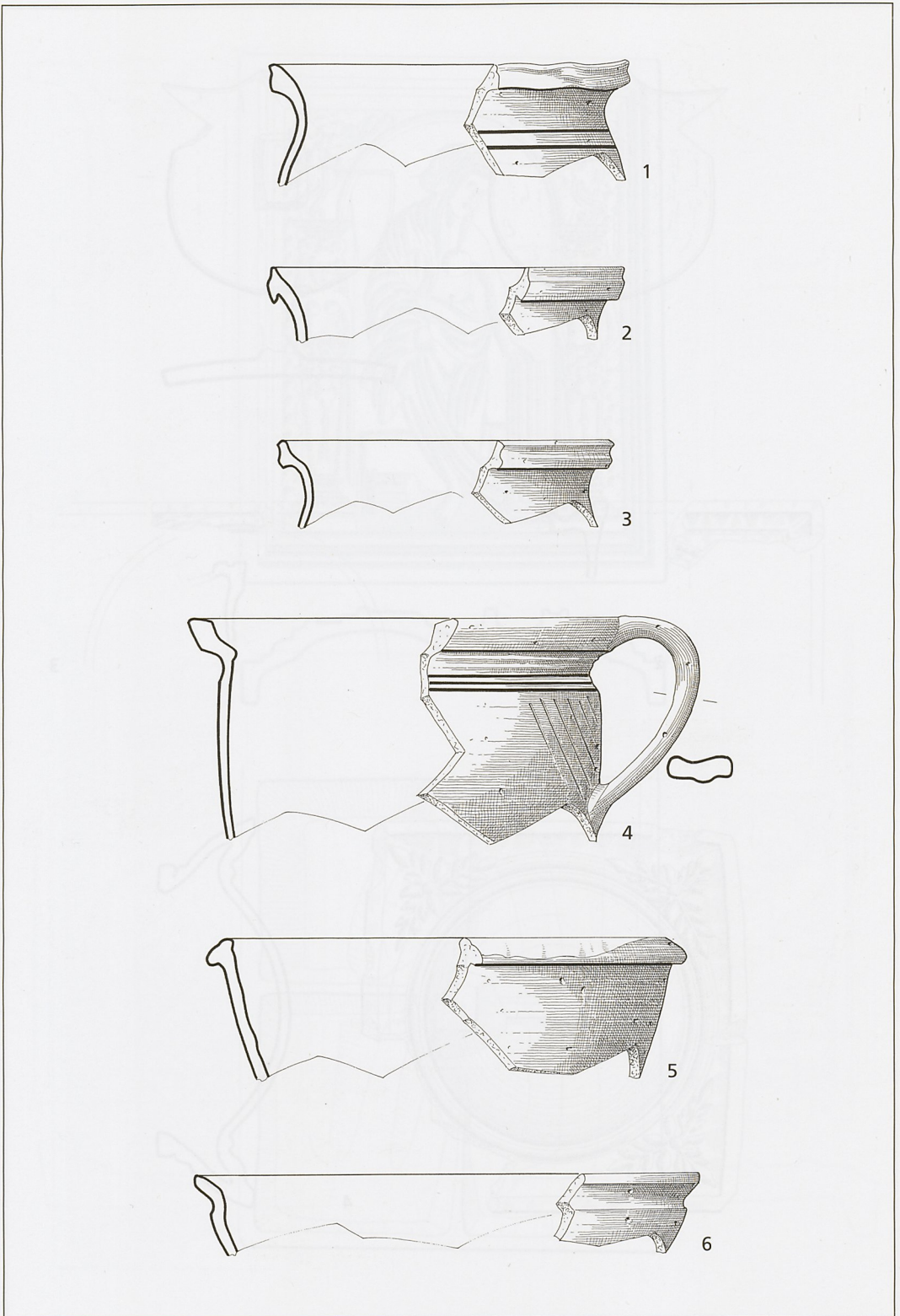

Esslingen am Neckar (Lkr. Esslingen). M 1 : 3.

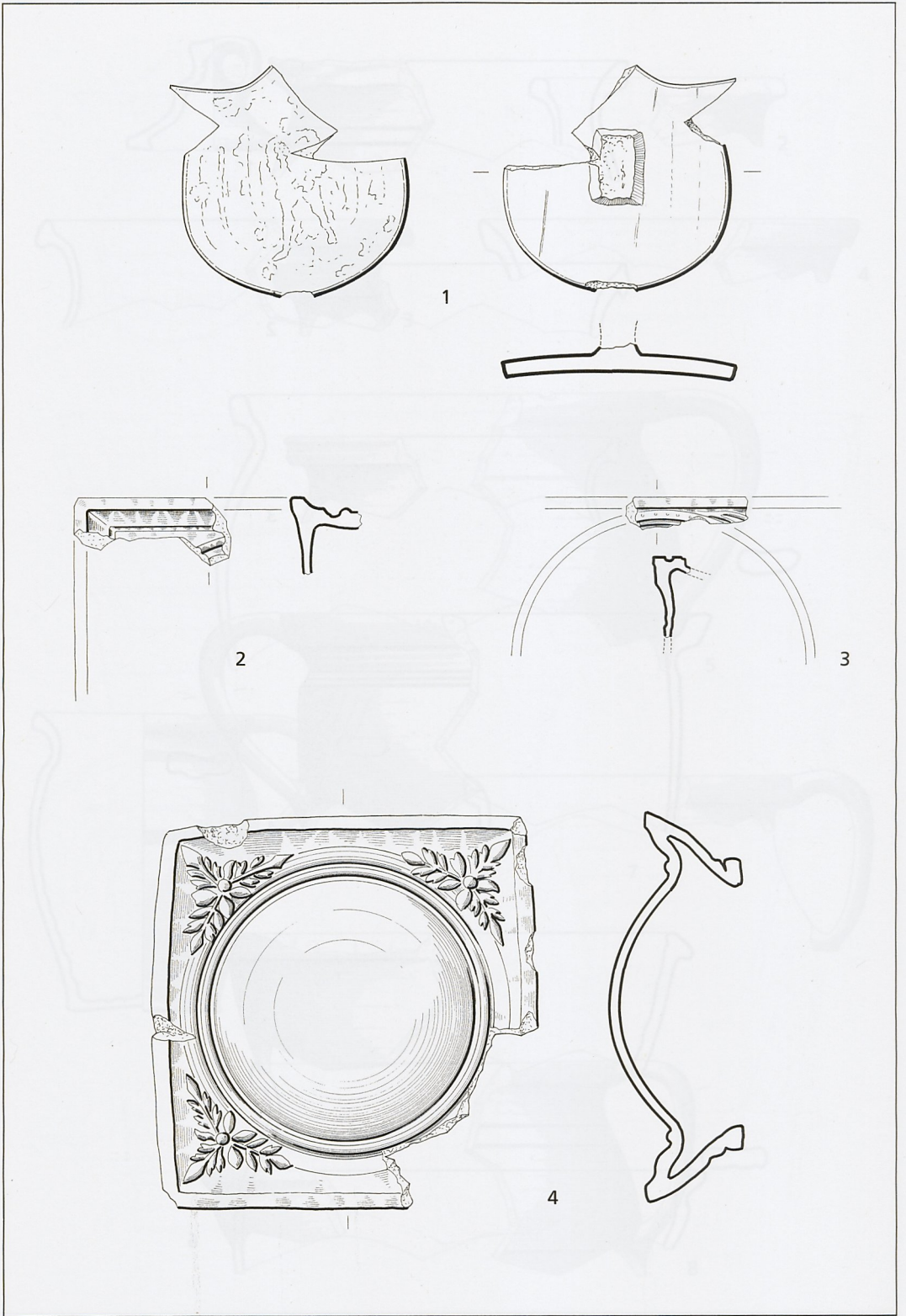

Esslingen am Neckar (Lkr. Esslingen). M 1 : 4.

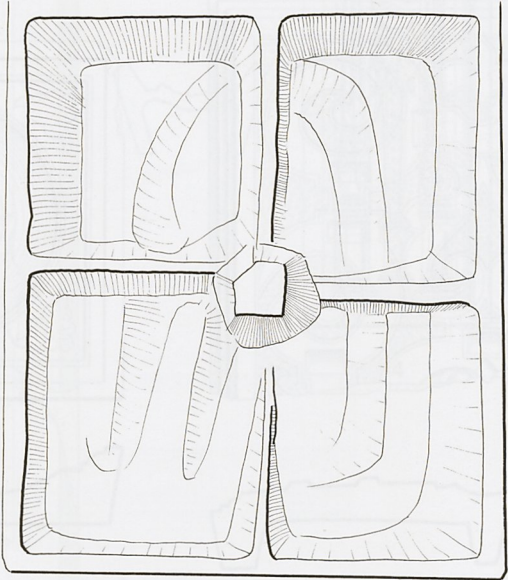

Esslingen am Neckar (Lkr. Esslingen). M 1 : 4.

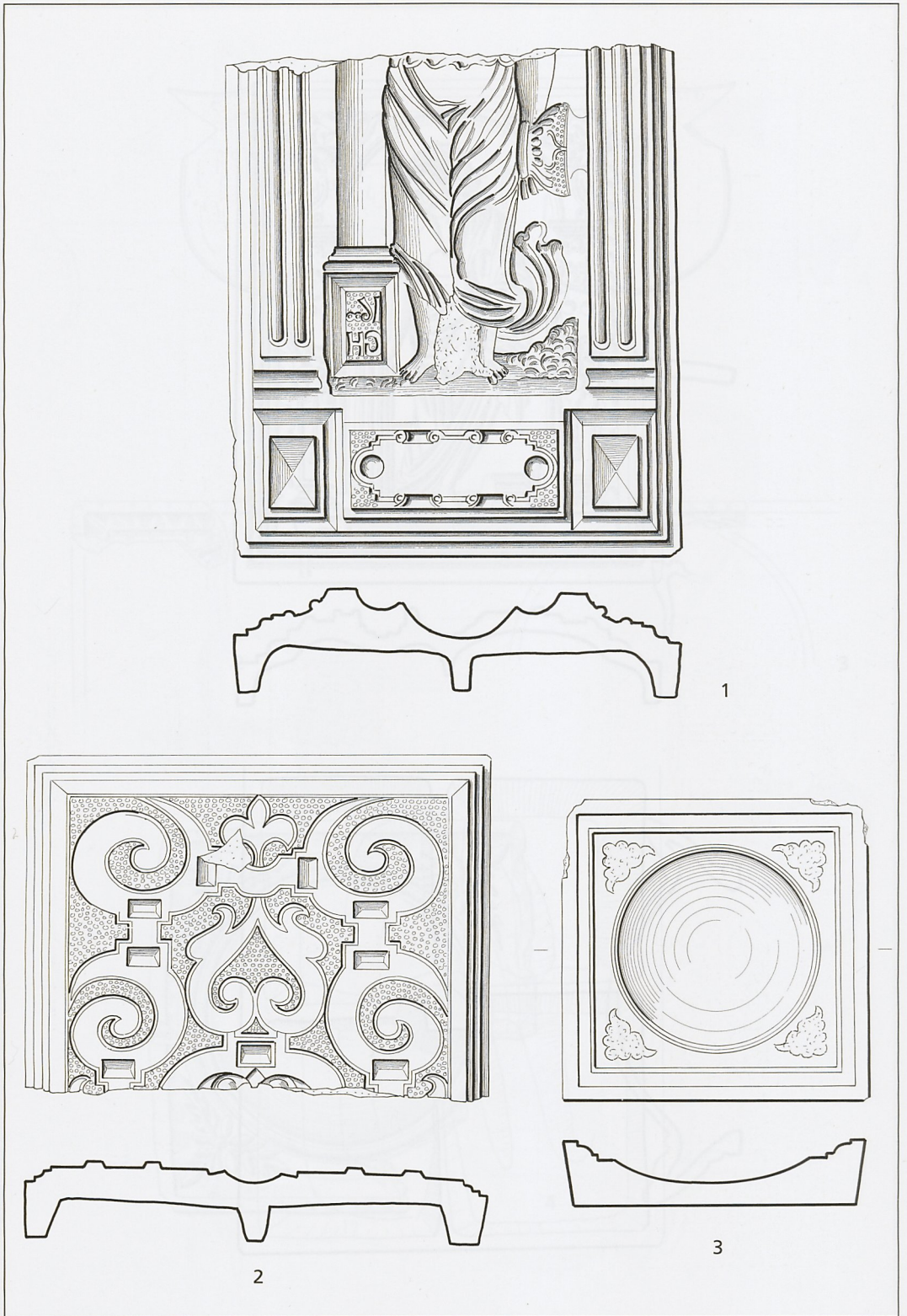

Esslingen am Neckar (Lkr. Esslingen). M 1 : 4.

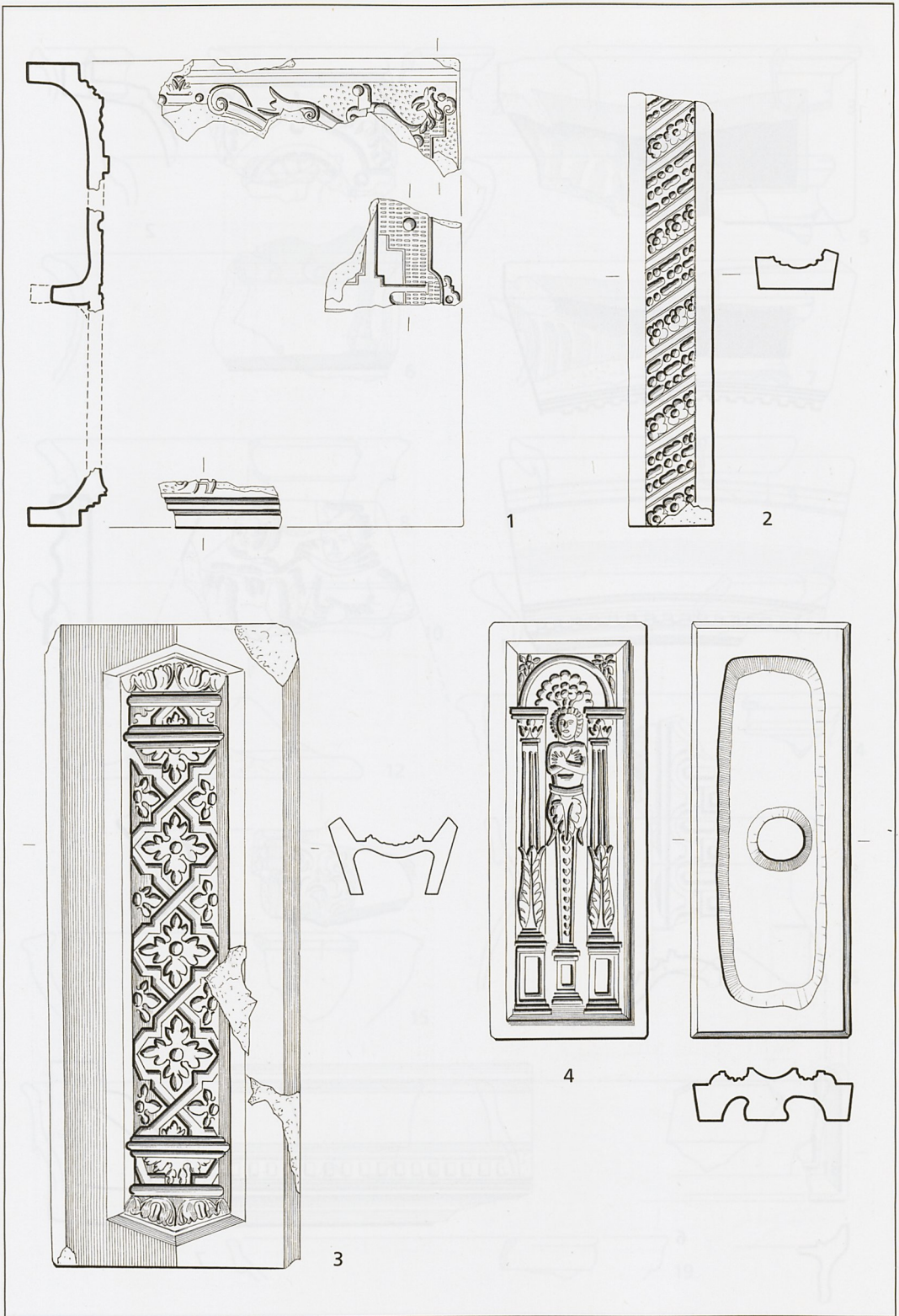

Esslingen am Neckar (Lkr. Esslingen). M 1 : 4.

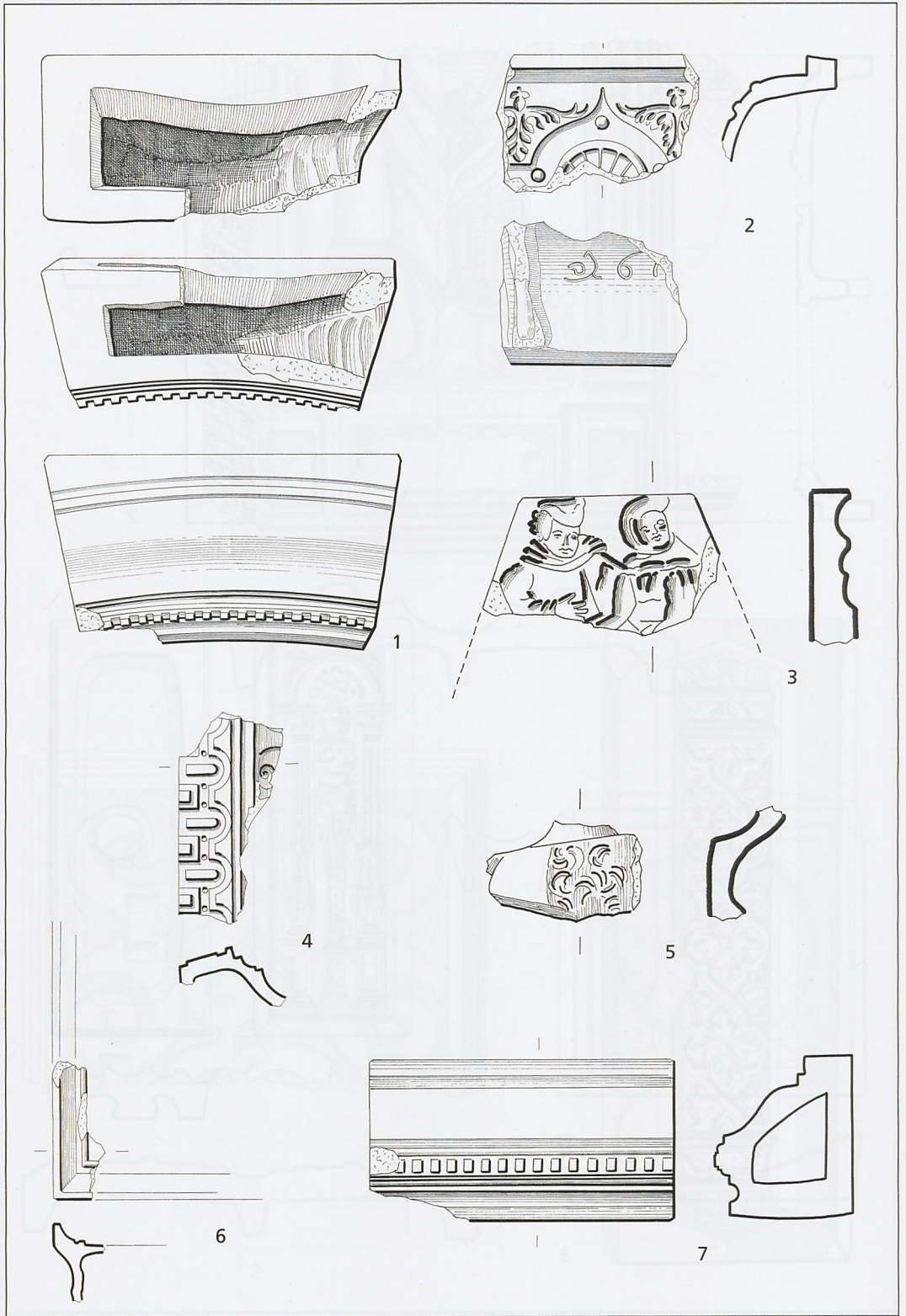

Esslingen am Neckar (Lkr. Esslingen). M 1 : 4; 3.5 M 1 : 2.

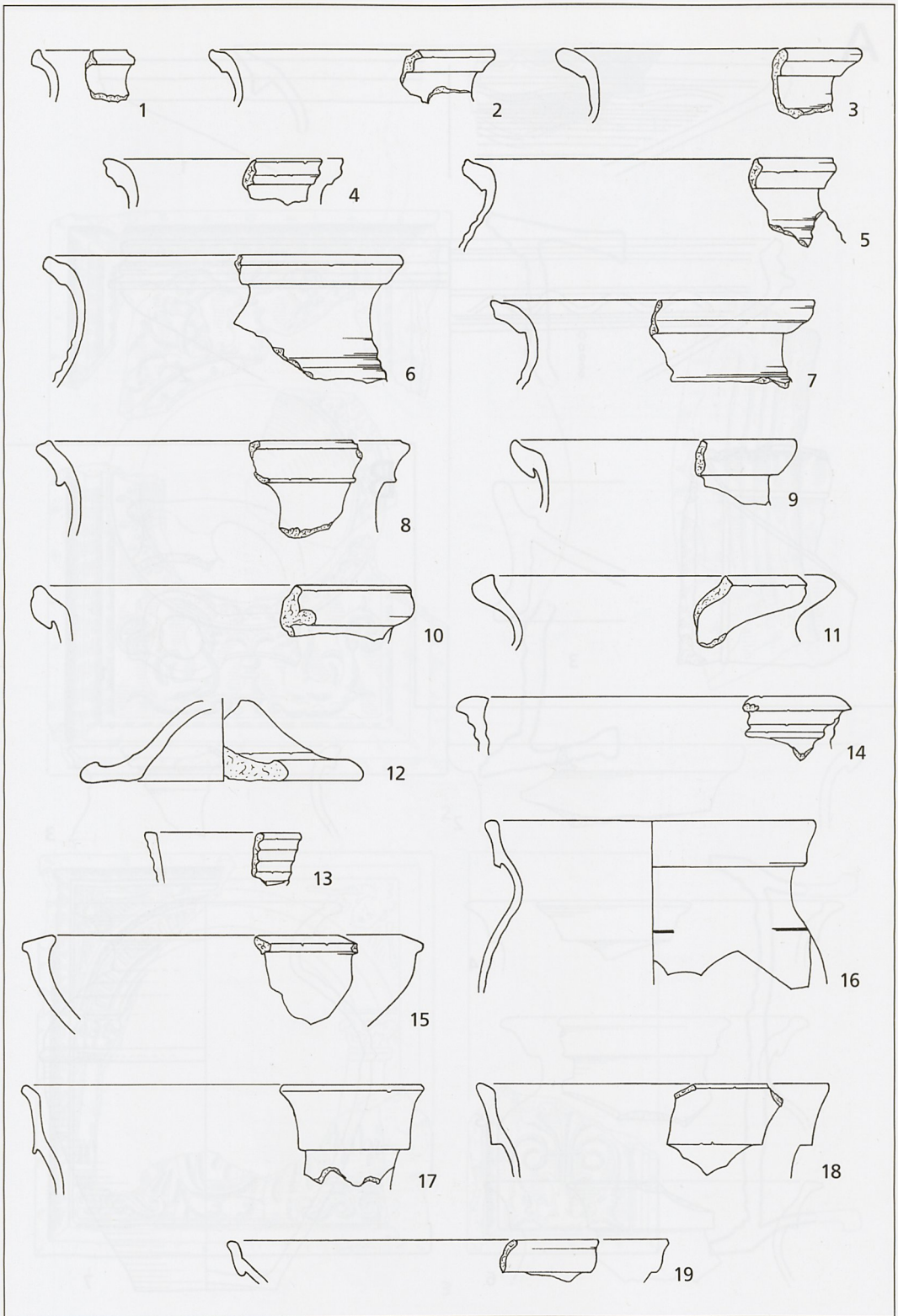

Graben-Neudorf Neudorf (Lkr. Karlsruhe). M 1:3.

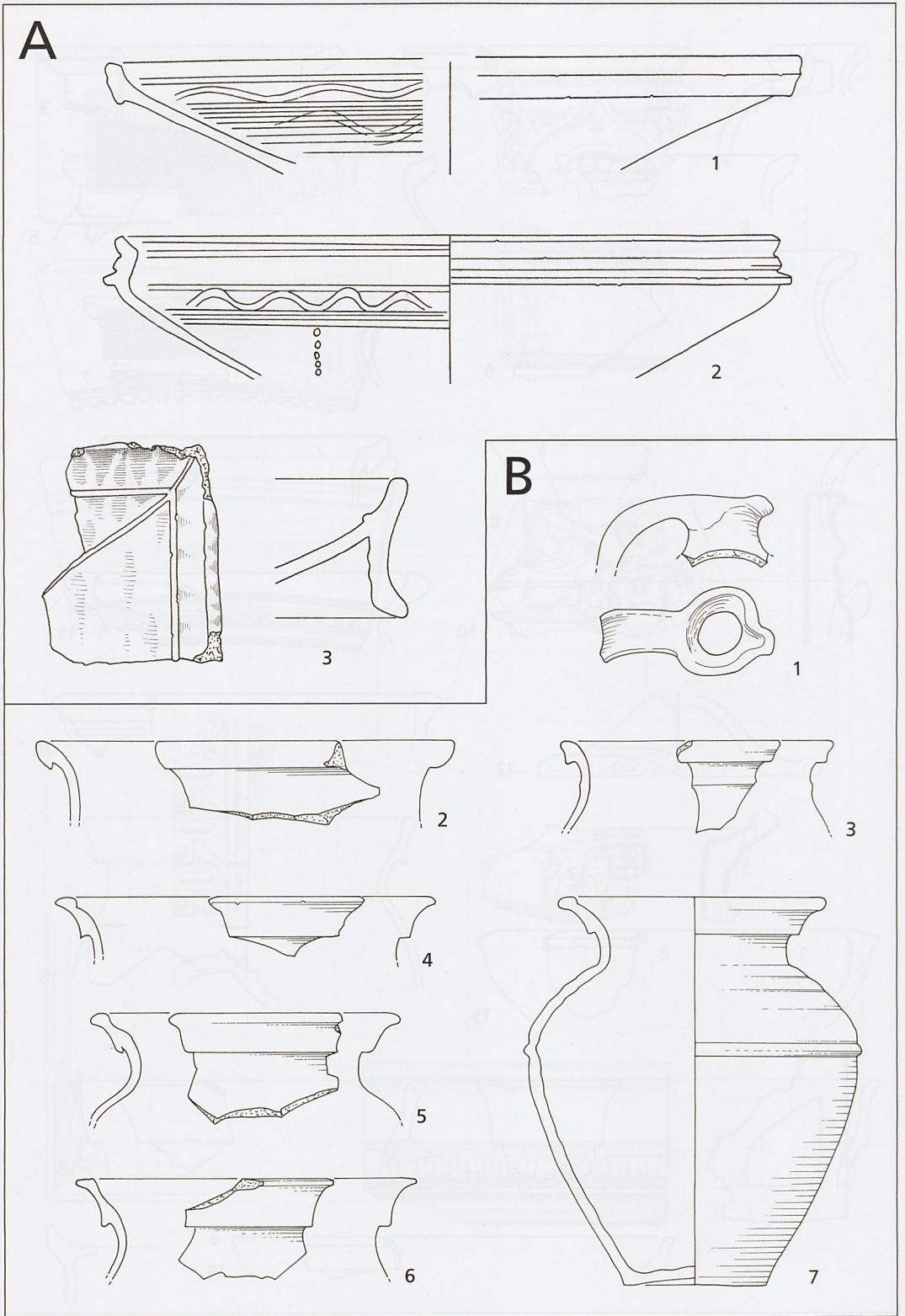

A Graben-Neudorf Neudorf (Lkr. Karlsruhe). M 1 : 3. – B Güglingen (Lkr. Heilbronn). M 1 : 3.

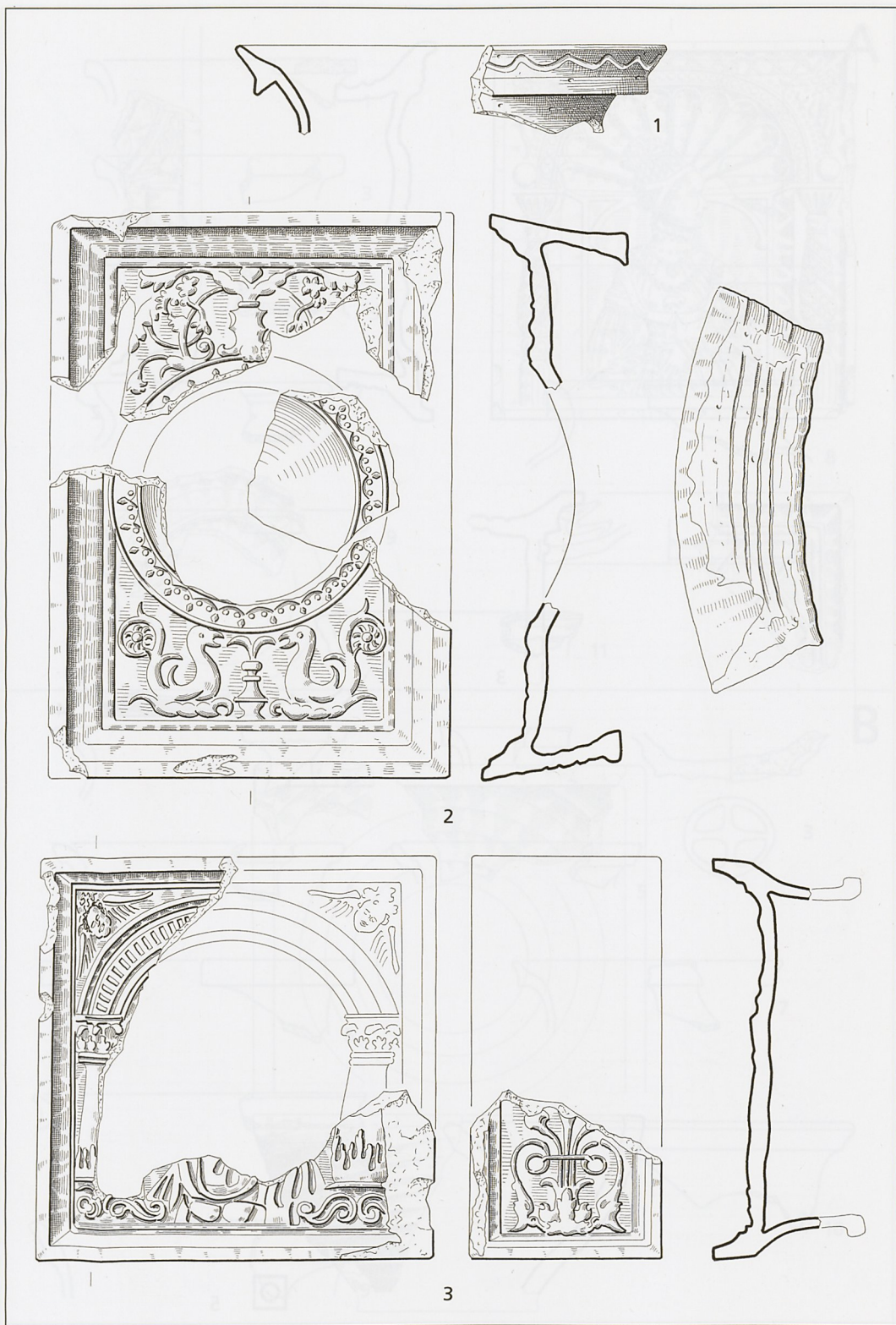

Heilbronn Horkheim. M 1:3.

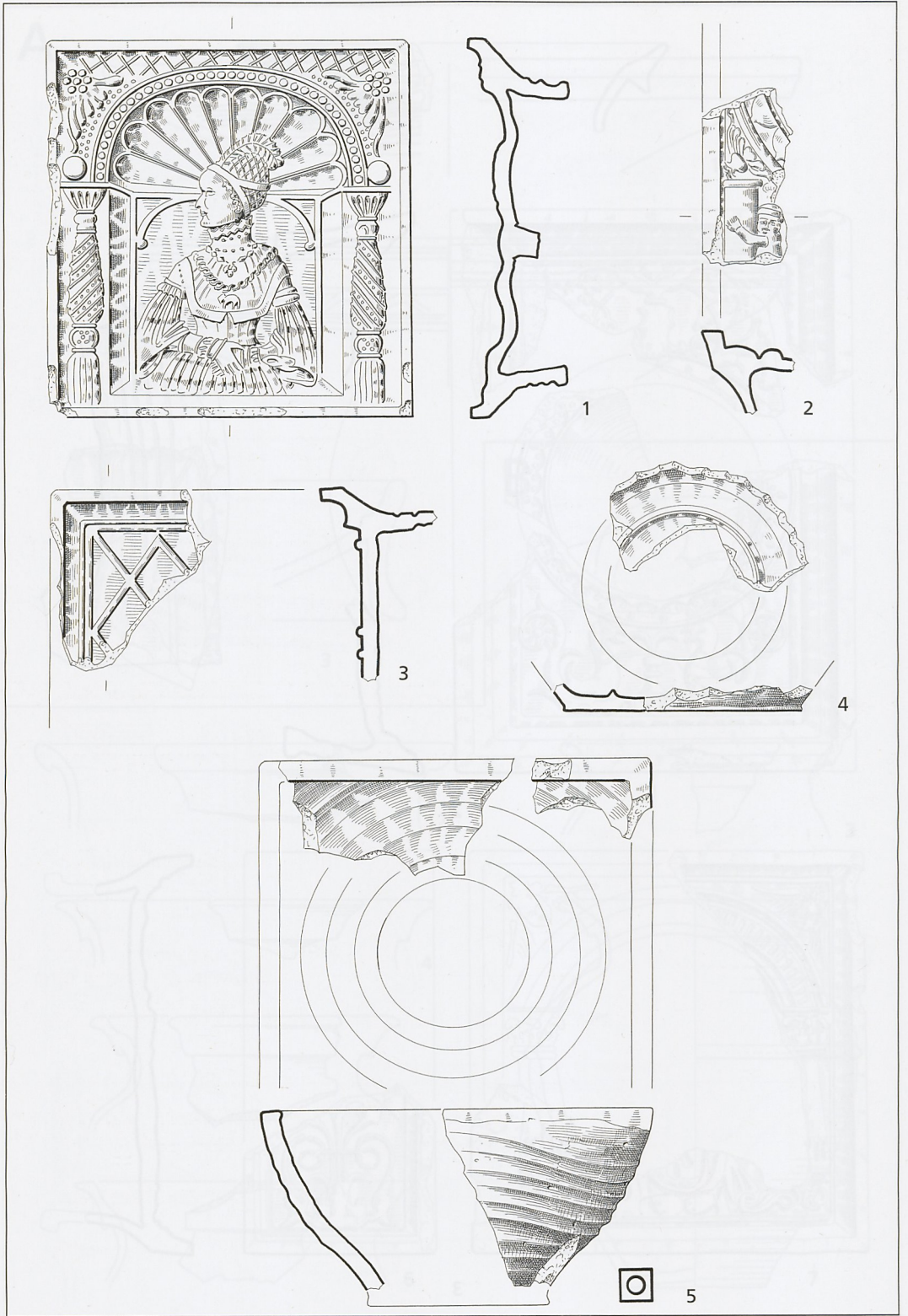

Heilbronn Horkheim. M 1:3.

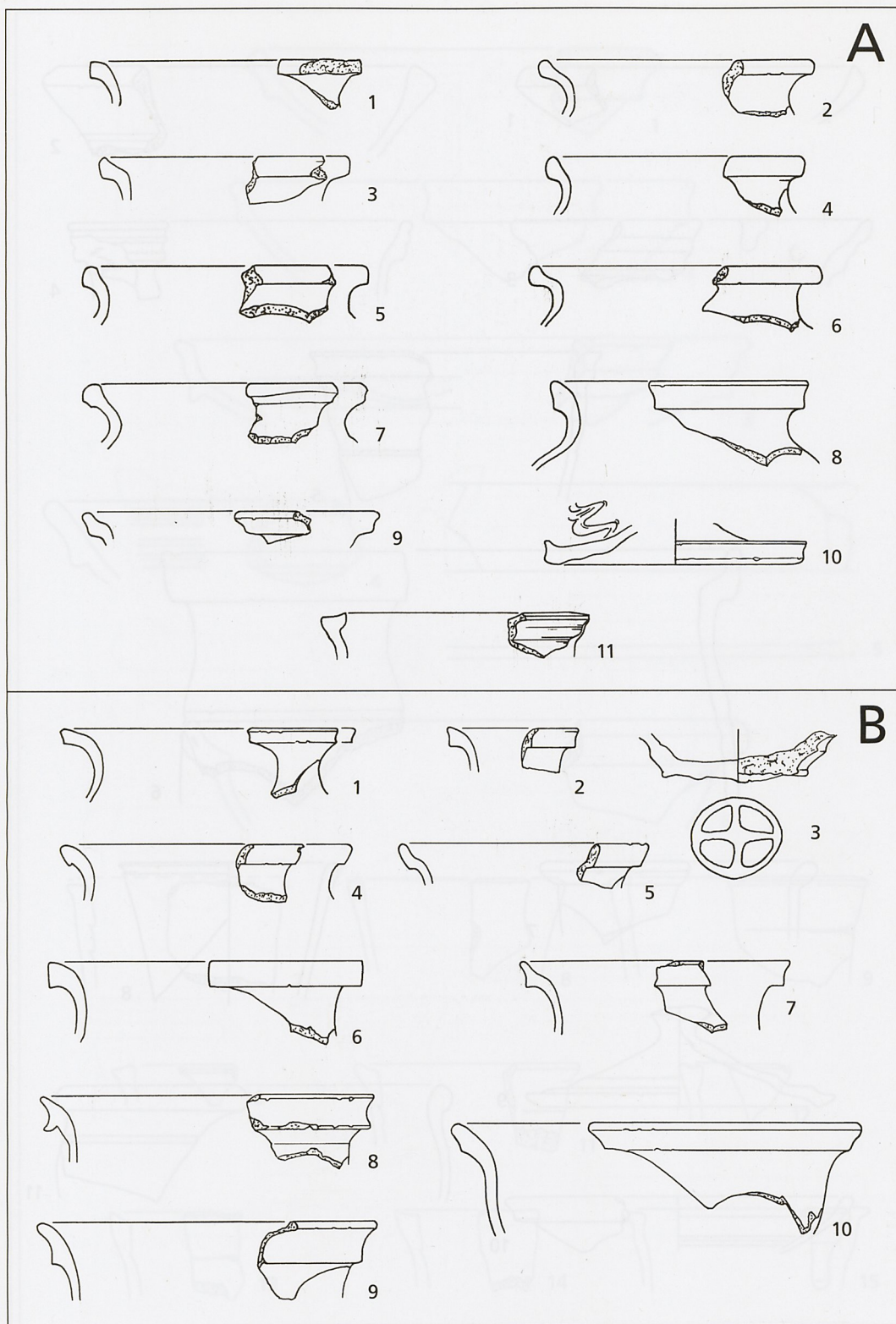

A Hirschberg a. d. Bergstr. Leutershausen (Rhein-Neckar-Kreis). M 1 : 3. –
 B Horb am Neckar (Lkr. Freudenstadt). Fdst. 1. M 1 : 3.

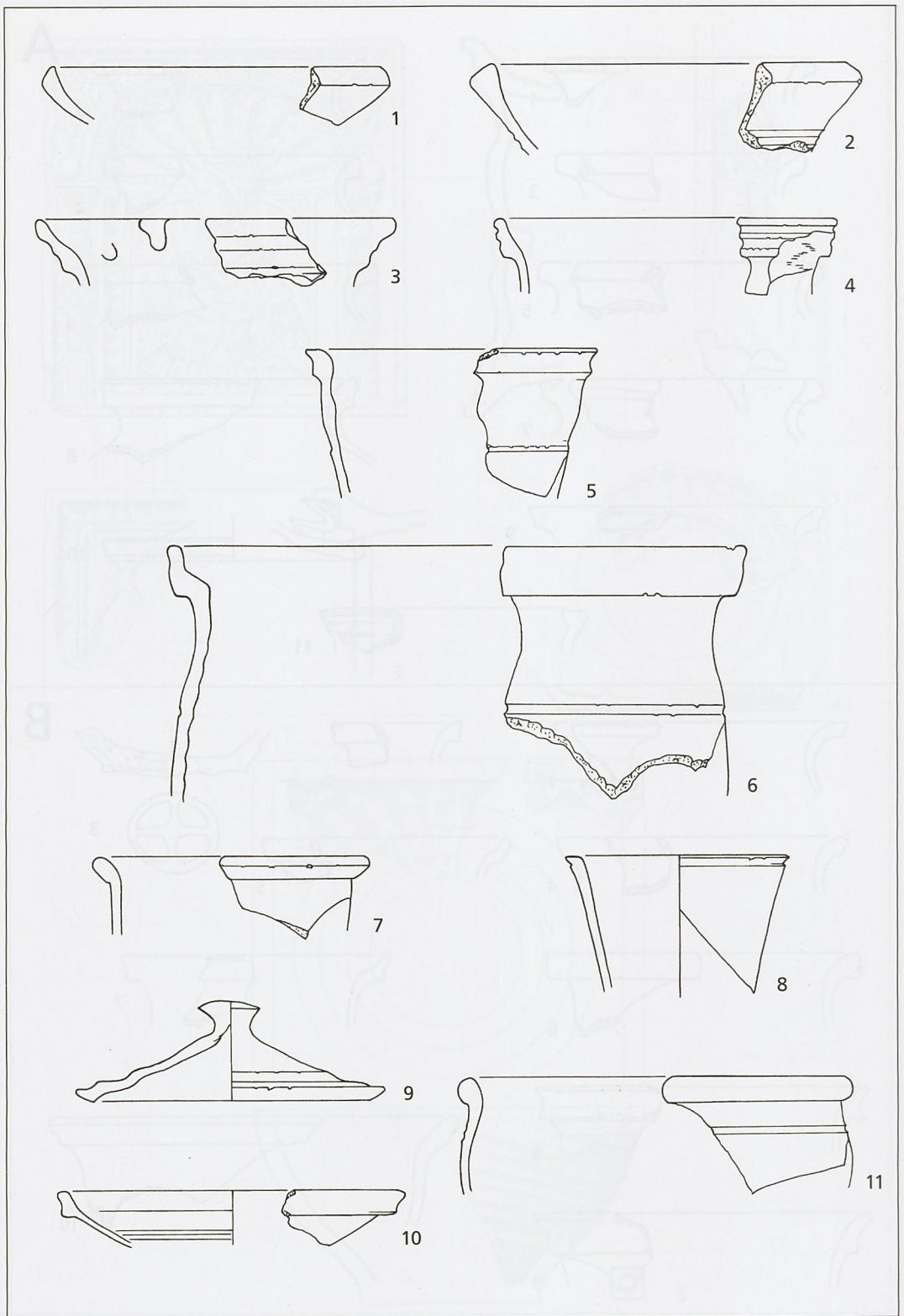

Horb am Neckar (Lkr. Freudenstadt). Fdst. 1. M 1 : 3.

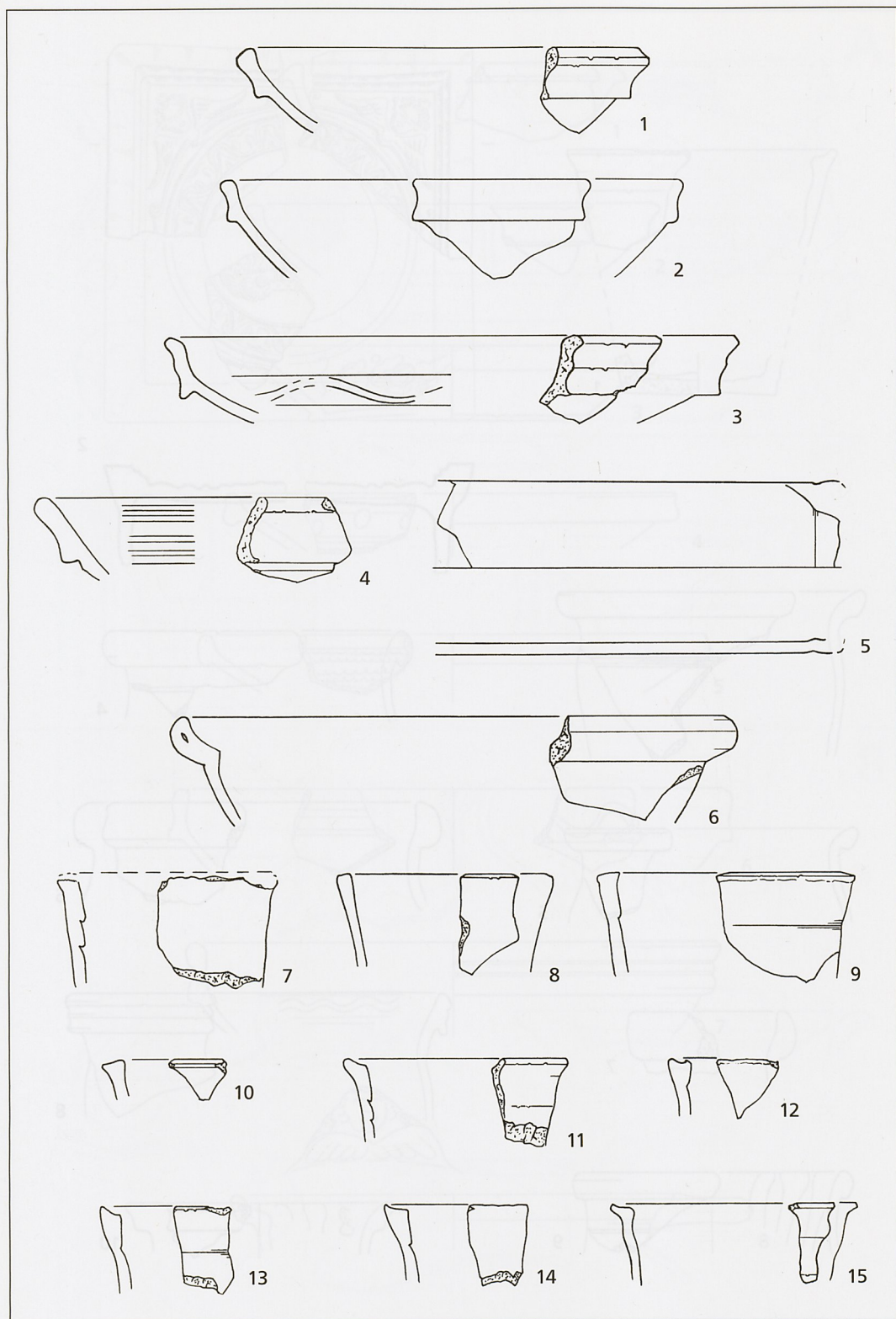

Horb am Neckar (Lkr. Freudenstadt). Fdst. 1. M 1 : 3.

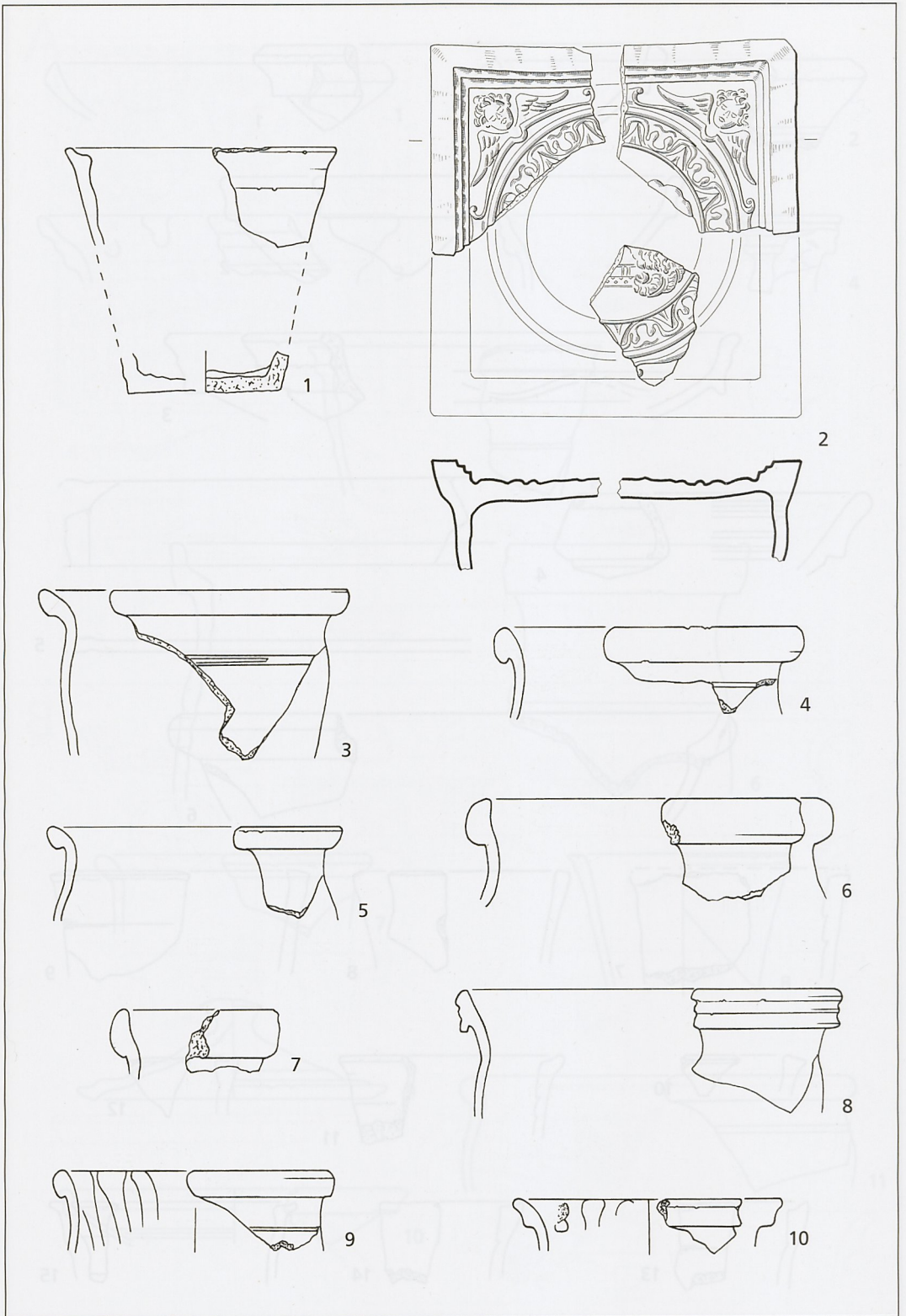

Horb am Neckar (Lkr. Freudenstadt). 1,2 Fdst. 1; 3-10 Fdst. 2. M 1 : 3.

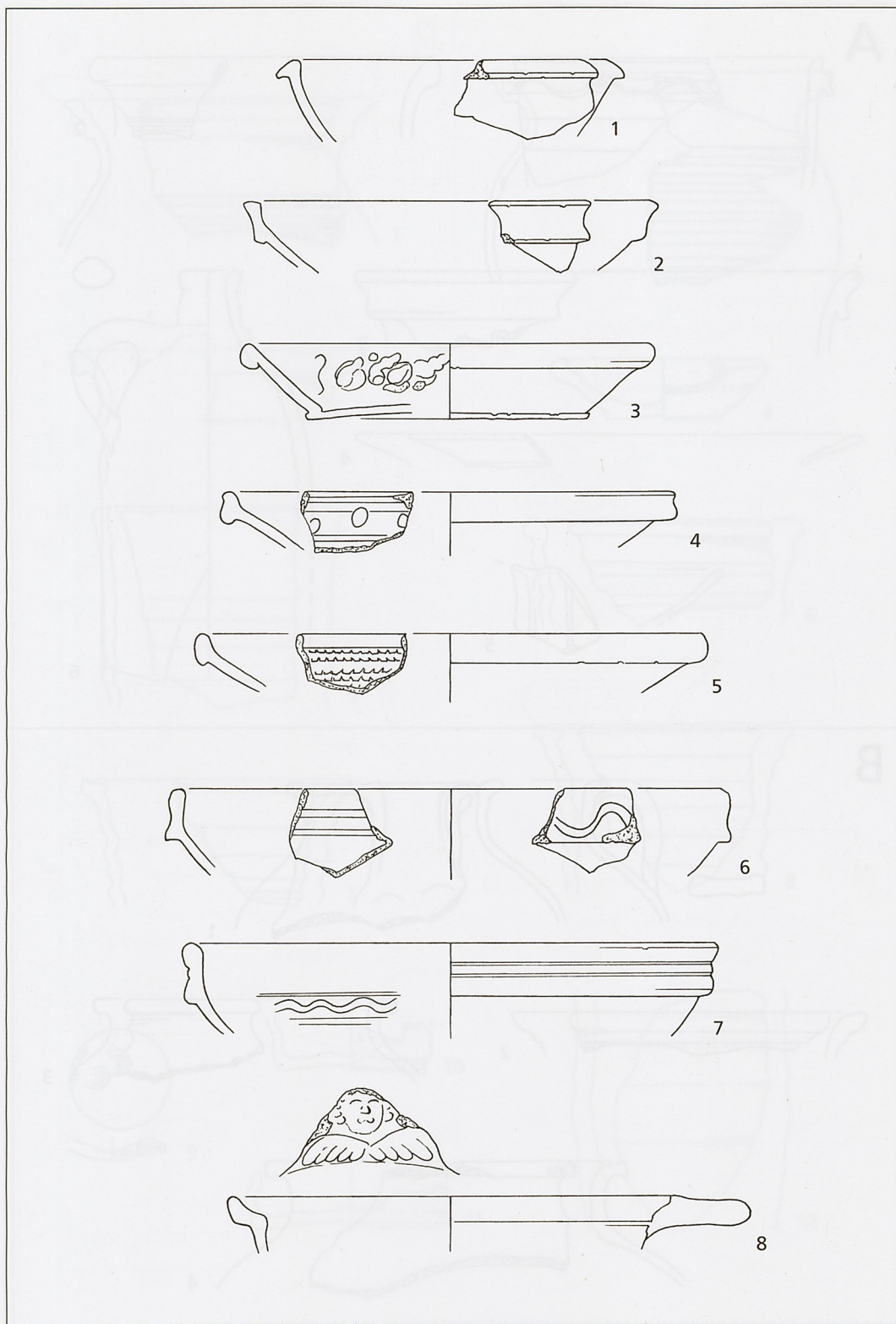

Horb am Neckar (Lkr. Freudenstadt). Fdst. 2. M 1 : 3.

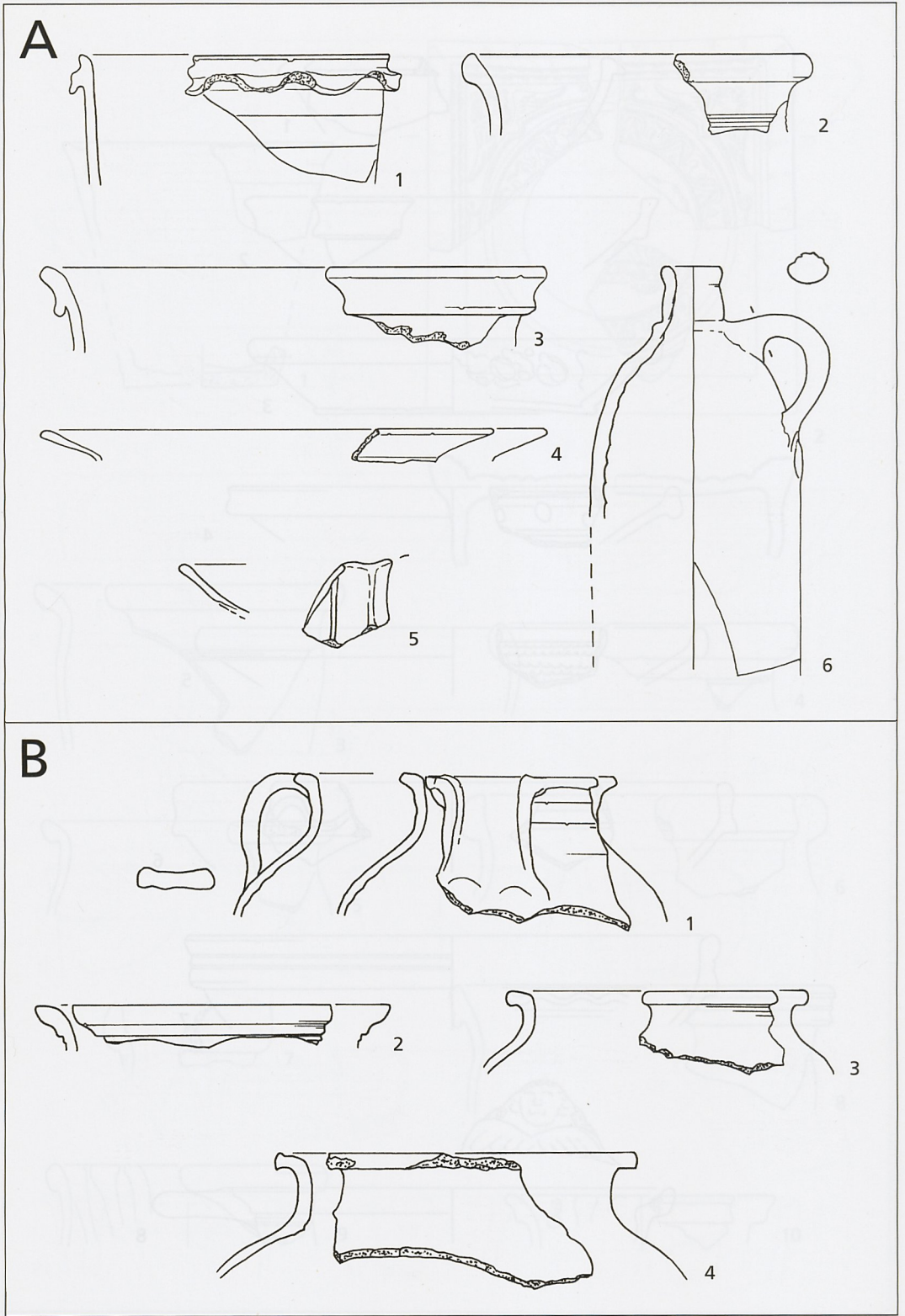

A Horb am Neckar (Lkr. Freudenstadt). Fdst. 2. M 1 : 3. – B Karlsruhe D u r l a c h. M 1 : 3.

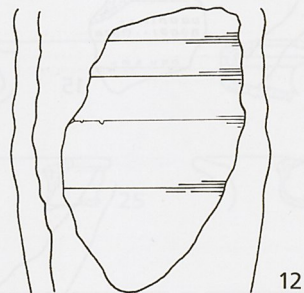
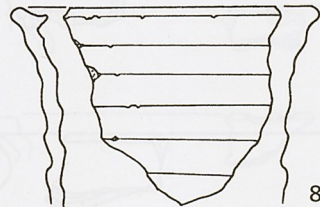
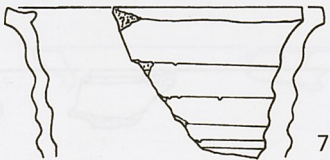
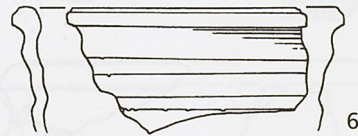
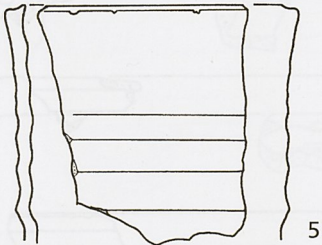
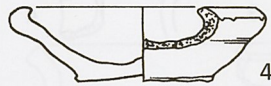
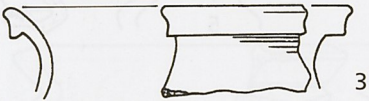
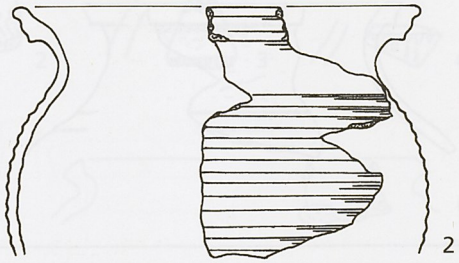
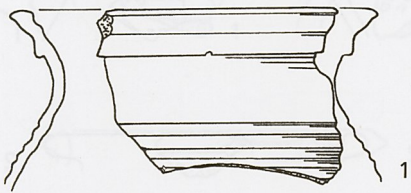

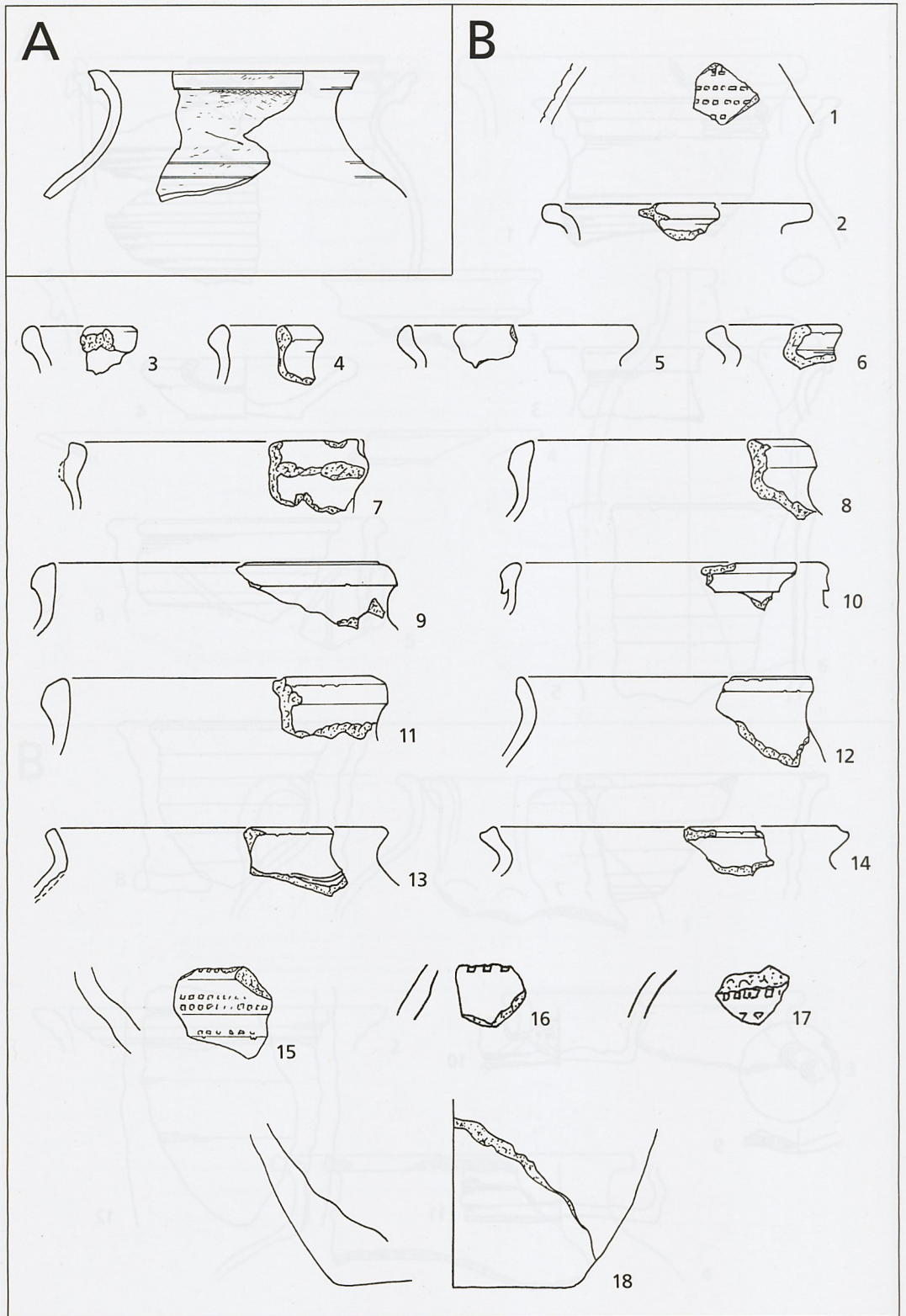

A Kenzingen (Lkr. Emmendingen). M 1 : 3. – B Kirchheim unter Teck Ötlingen (Lkr. Esslingen). M. 1 : 3; 16,17 M 1 : 2.

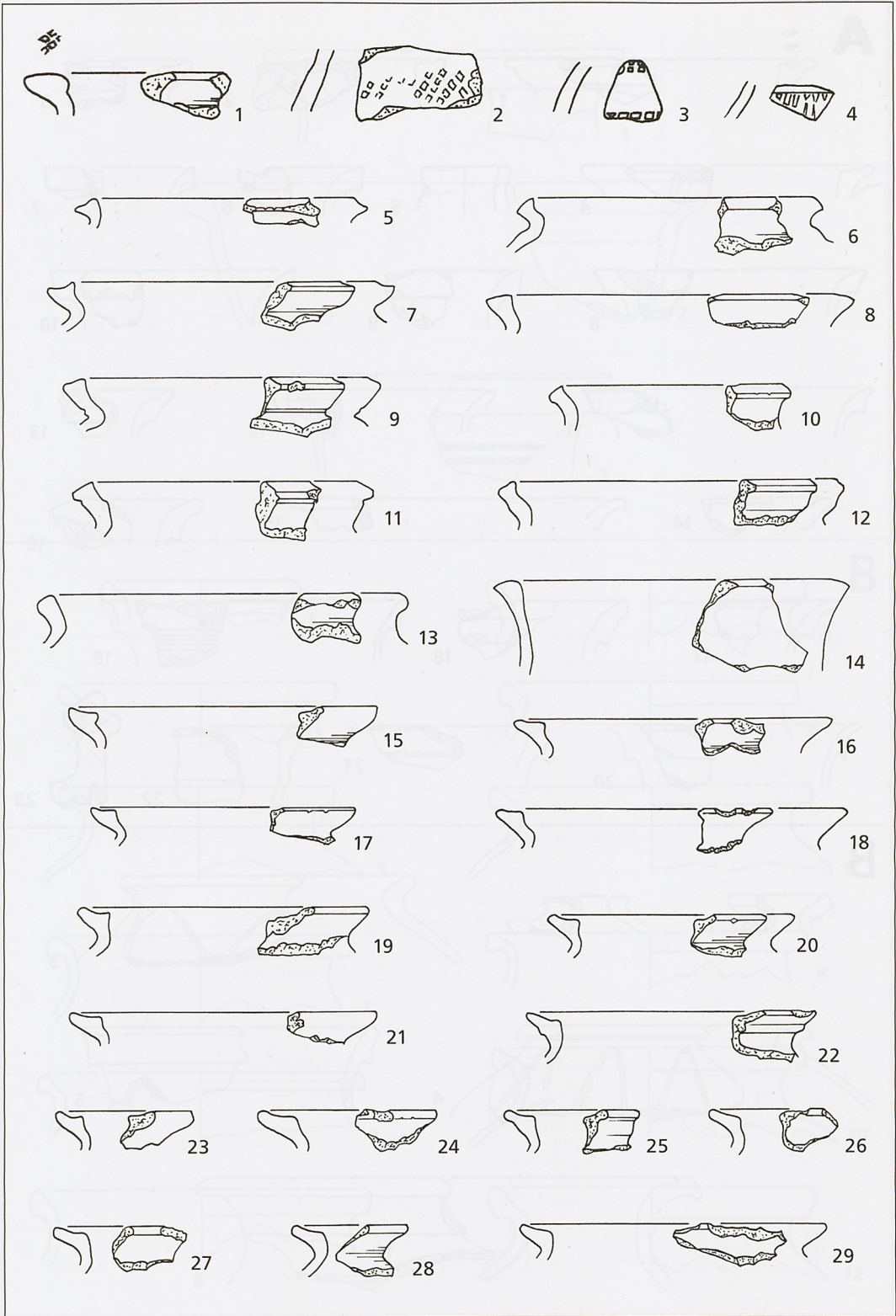

Kirchheim unter Teck Ötlingen (Lkr. Esslingen). M. 1 : 3; 1-4 M 1 : 2.

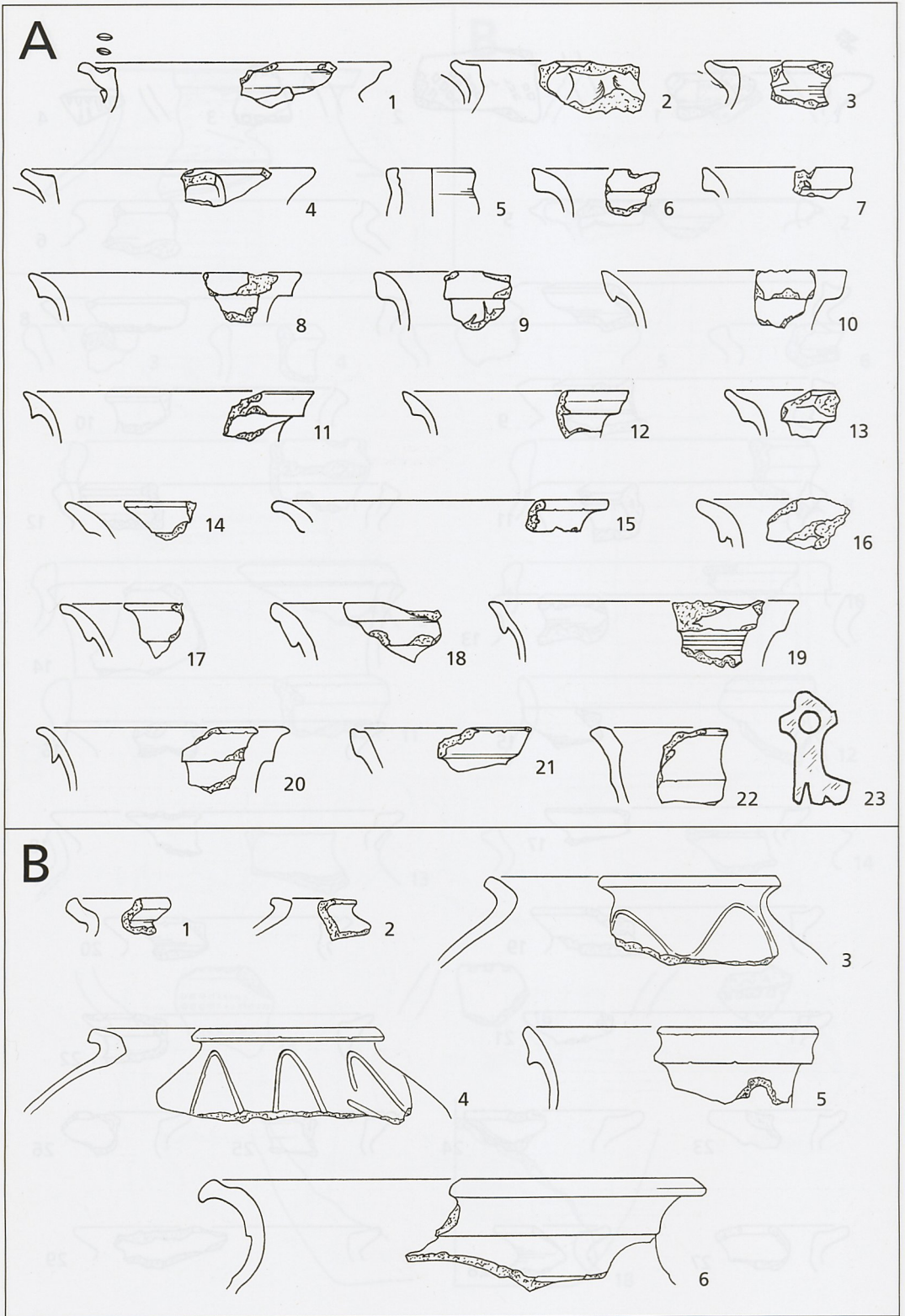

A Kirchheim unter Teck Ötlingen (Lkr. Esslingen), M. 1 : 3; 23 M 1 : 2. -
 B Loßburg Unterbrändi (Lkr. Freudenstadt), M 1 : 3.

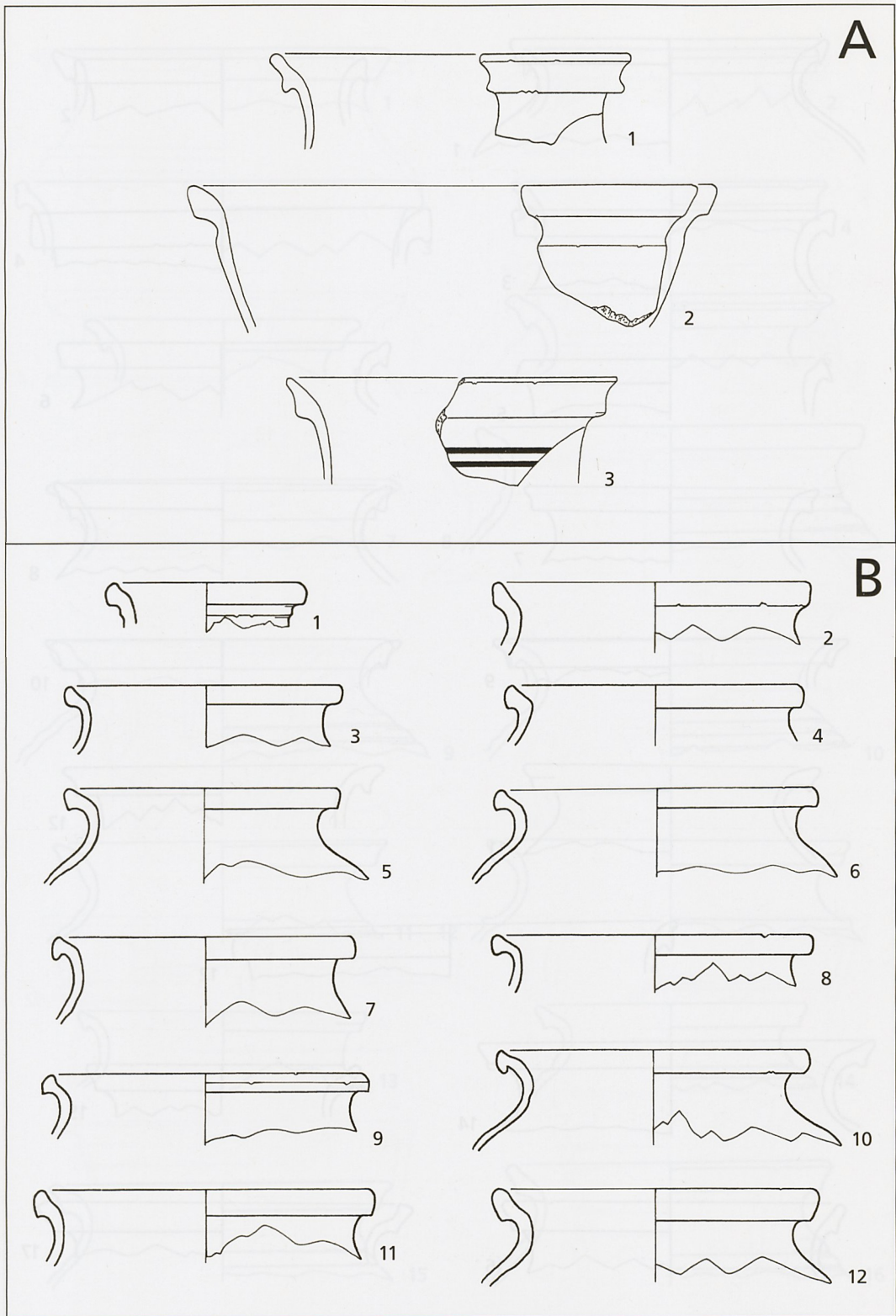

A Loßburg Unterbrändi (Lkr. Freudenstadt). M 1:3. -
 B Mühlacker Lienzingen (Enzkreis). M 1:3.

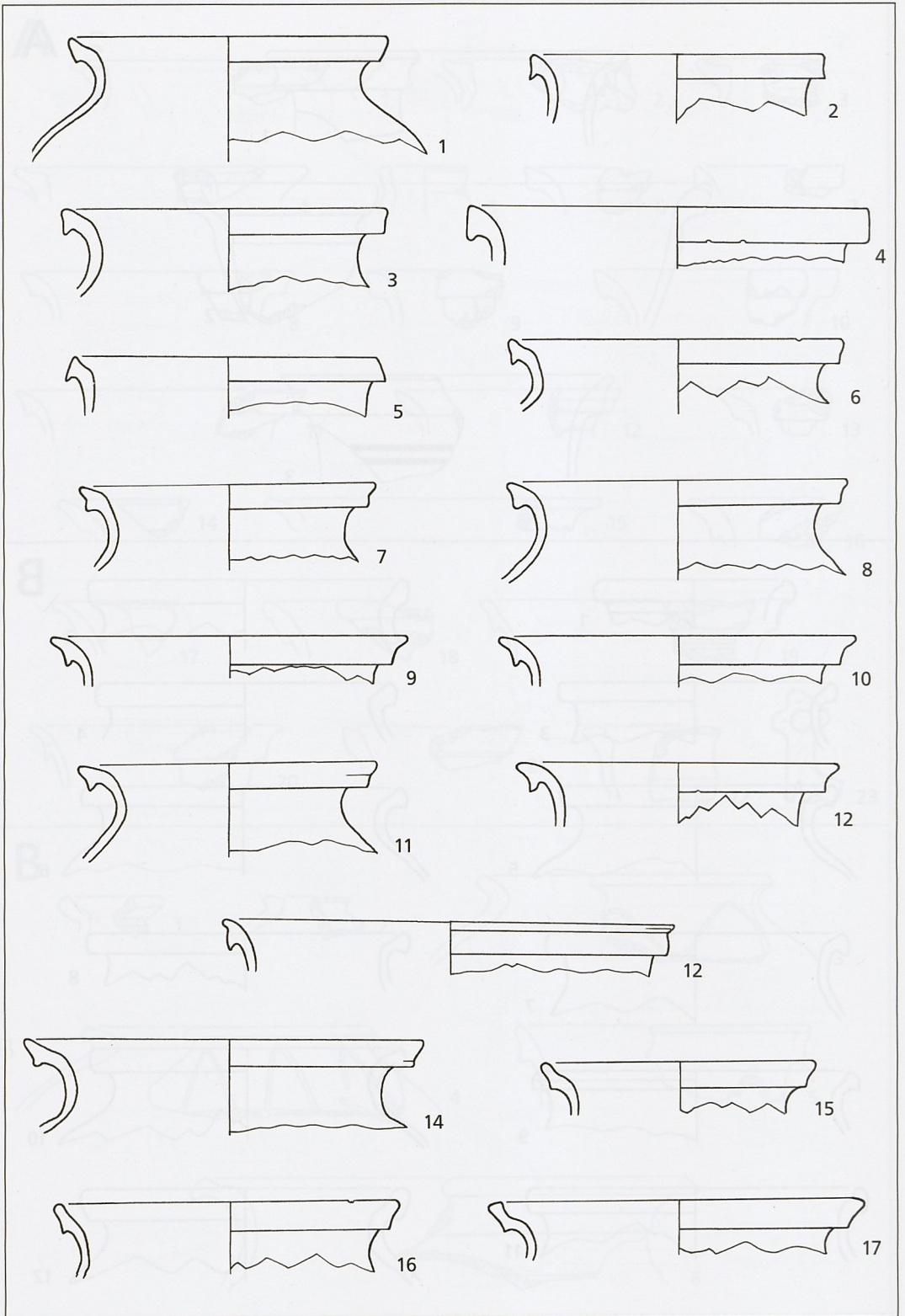

Mühlacker Lienzungen (Enzkreis). M 1:3.

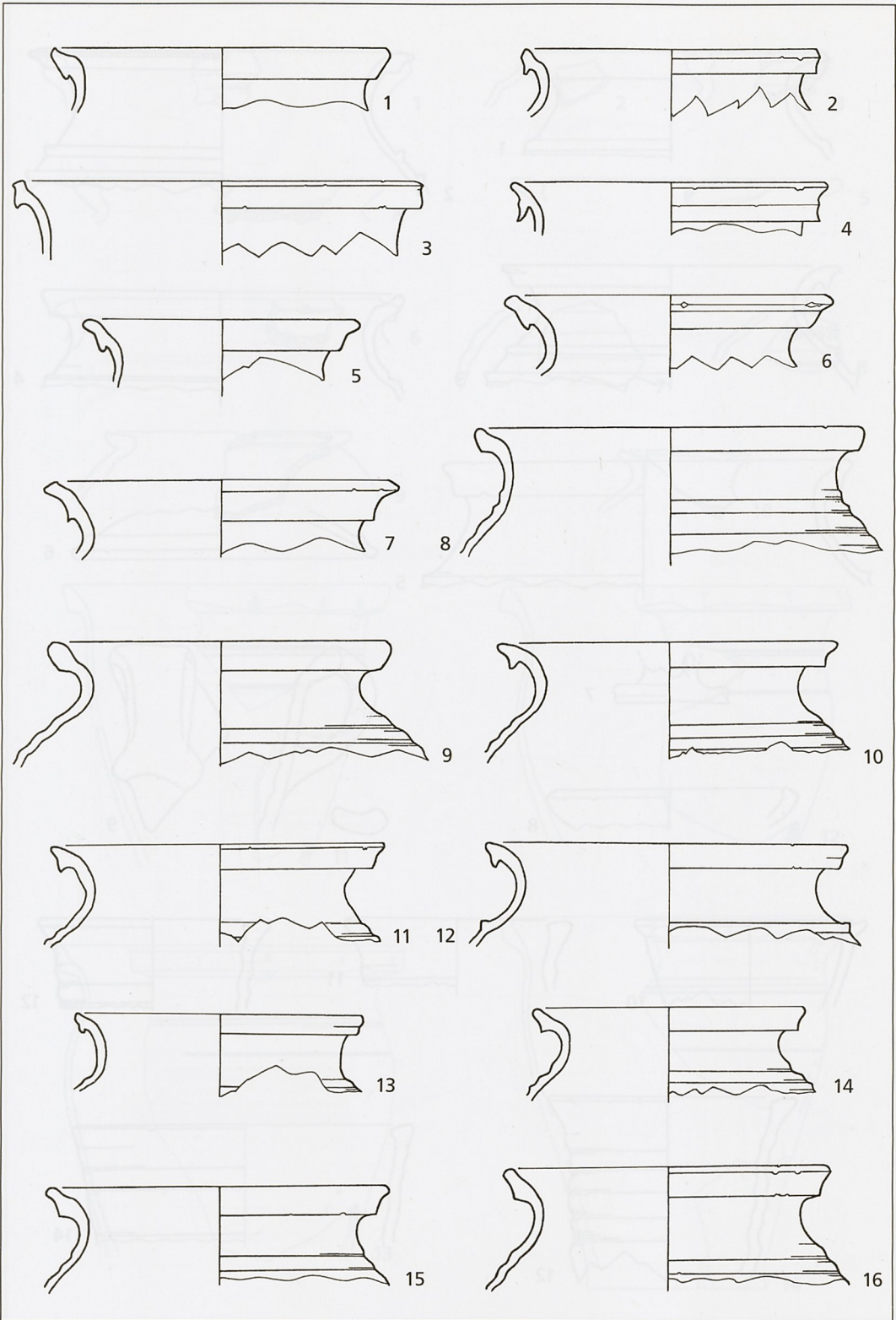

Mühlacker Lienzungen (Enzkreis). M 1:3.

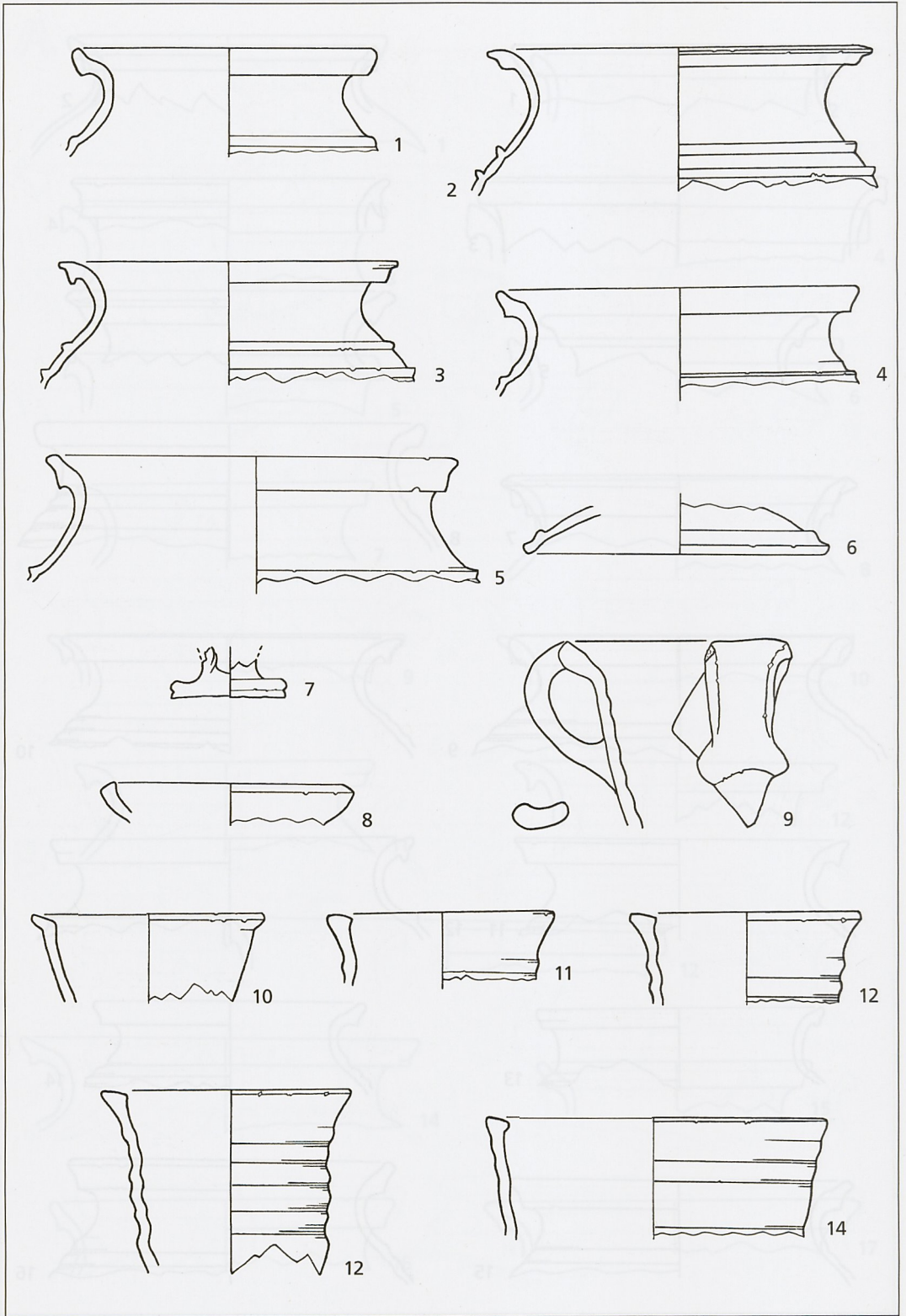

Mühlacker Lienzungen (Enzkreis). M 1:3.

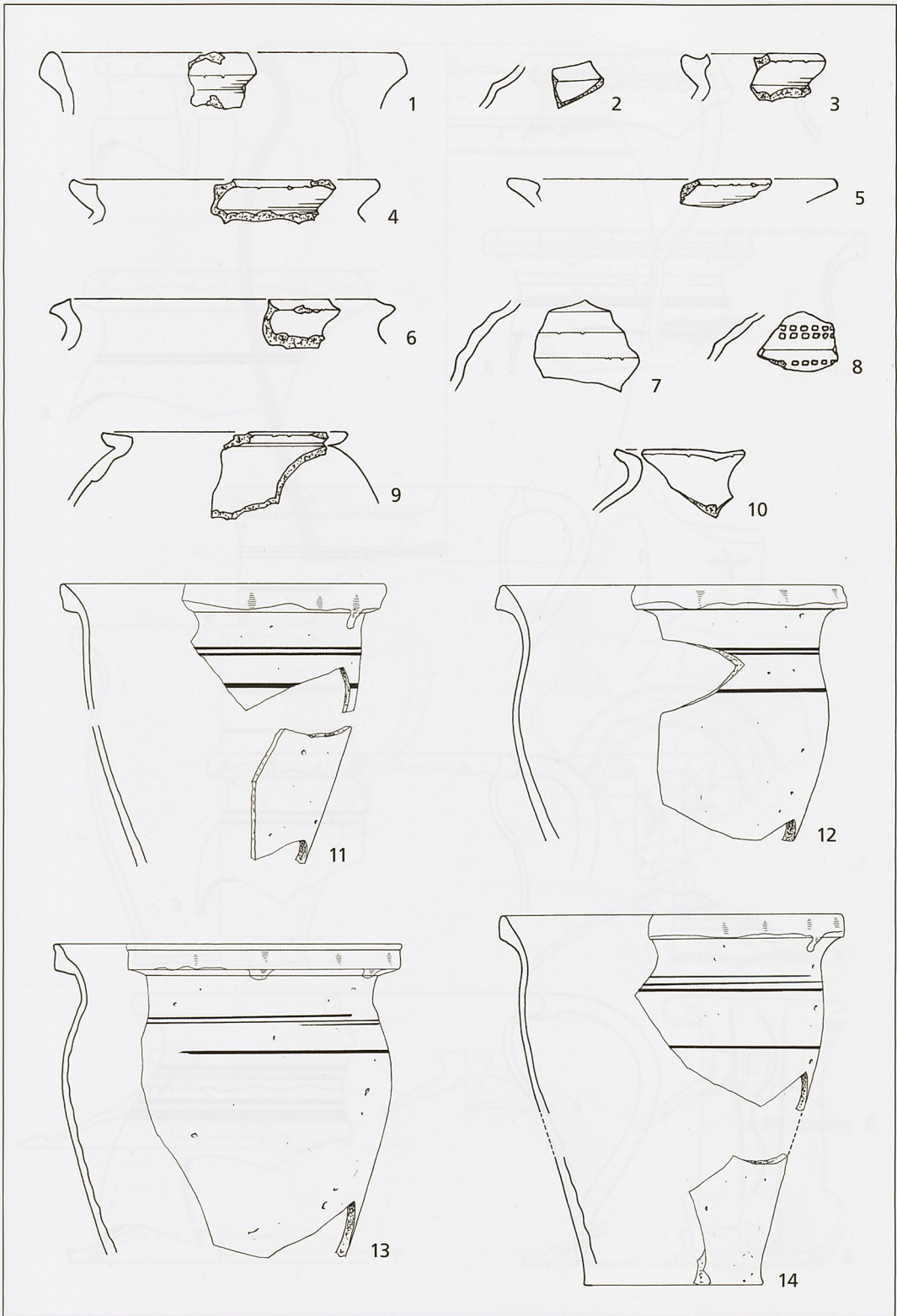

Neuhausen auf den Fildern (Lkr. Esslingen). 1–5 Fdst. 1; 6–10 Fdst. 2; 11–14 Fdst. 3. M 1 : 3.

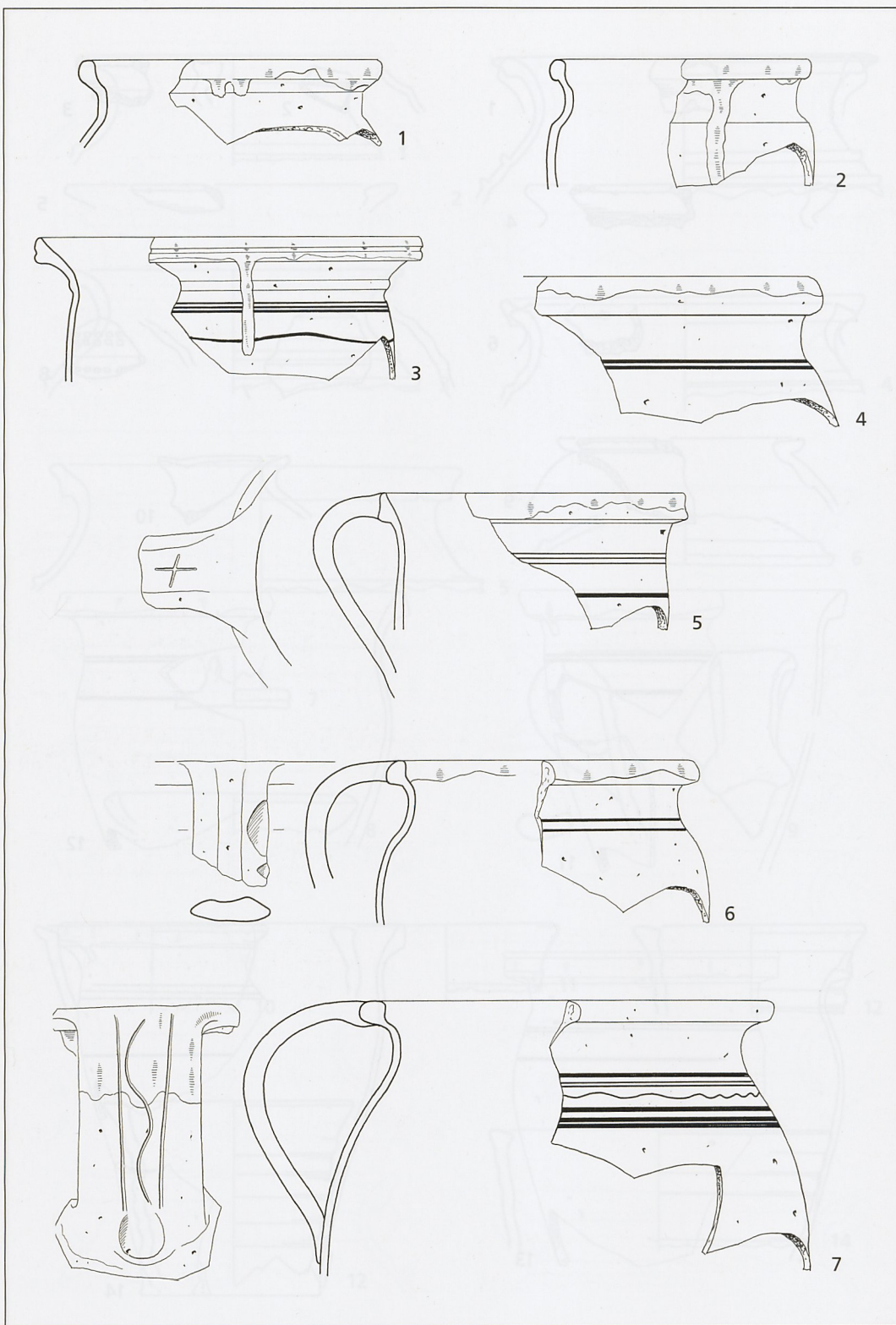

Neuhausen auf den Fildern (Lkr. Esslingen). Fdst. 3. M 1 : 3.

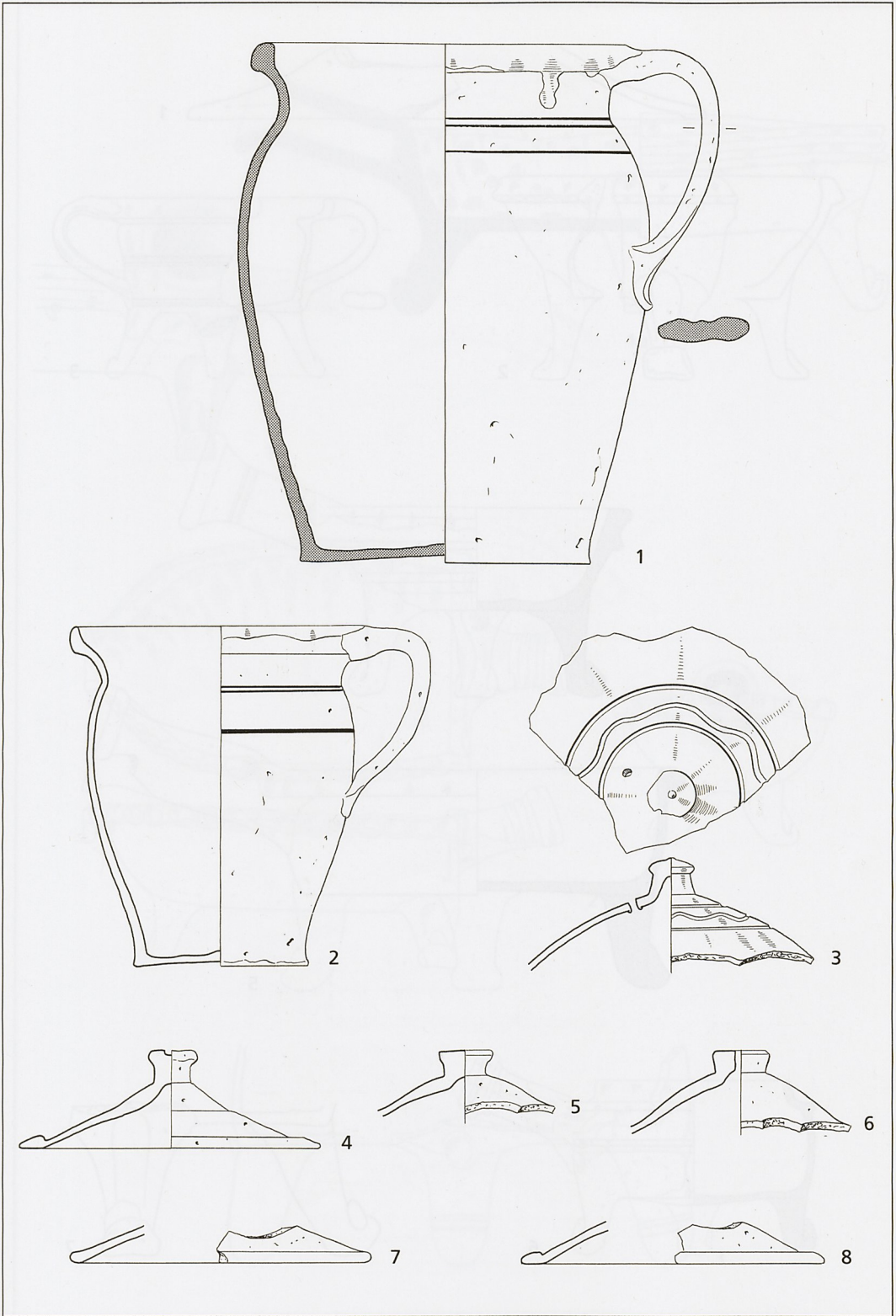

Neuhausen auf den Fildern (Lkr. Esslingen). Fdst. 3. M 1 : 3.

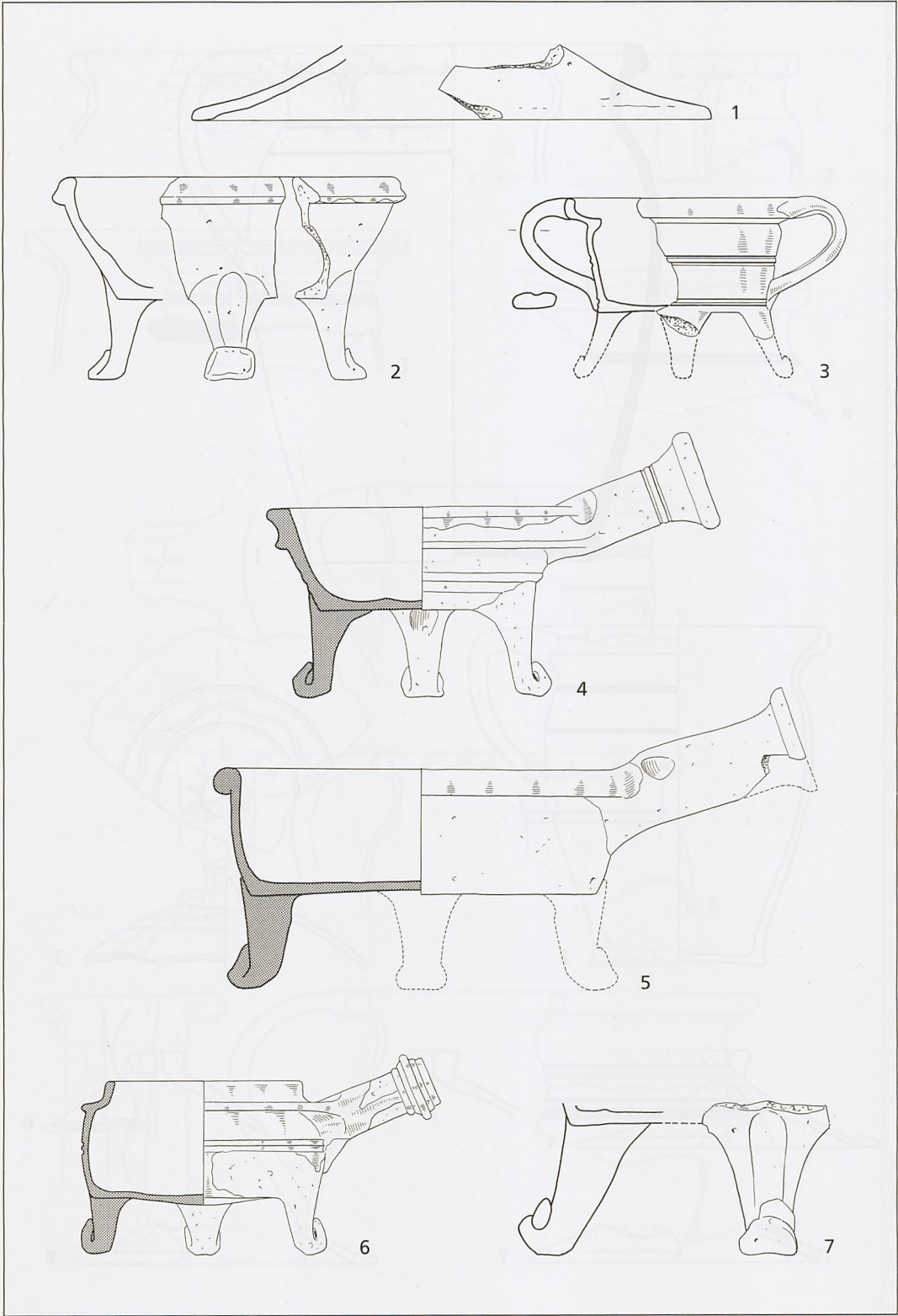

Neuhausen auf den Fildern (Lkr. Esslingen). Fdst. 3. M 1 : 3.

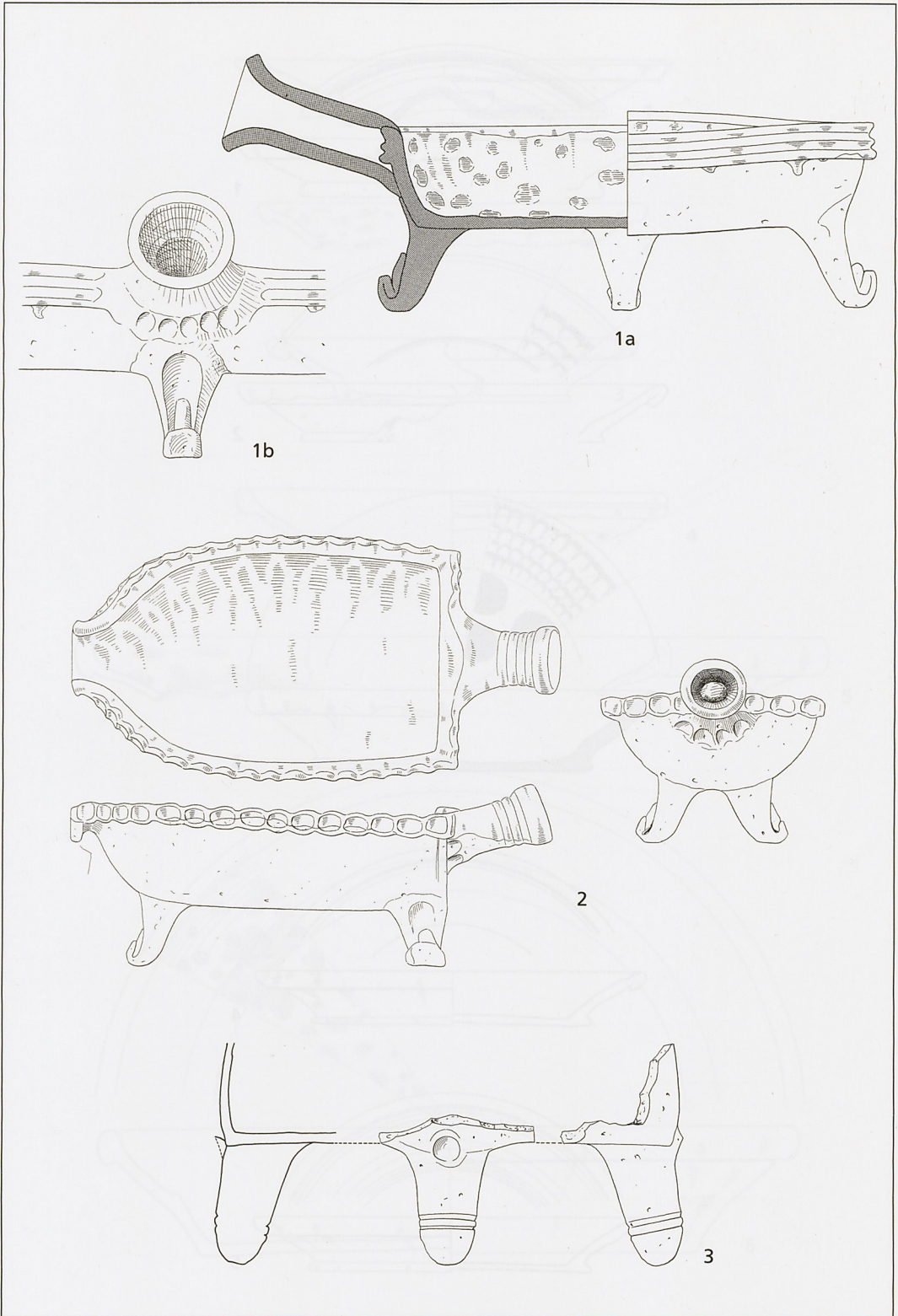

Neuhausen auf den Fildern (Lkr. Esslingen). Fdst. 3. M 1 : 4.

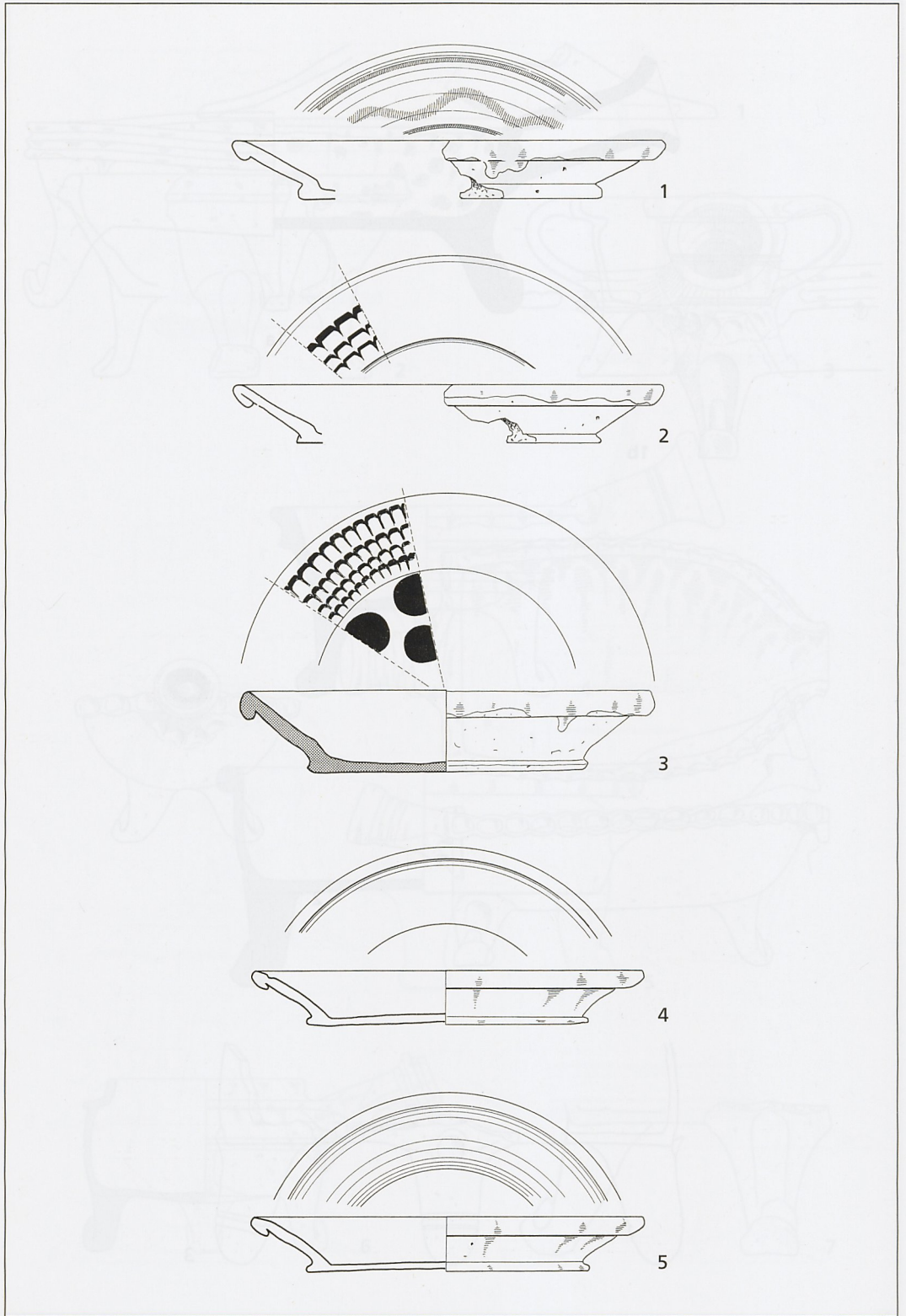

Neuhausen auf den Fildern (Lkr. Esslingen). Fdst. 3. M 1 : 3.

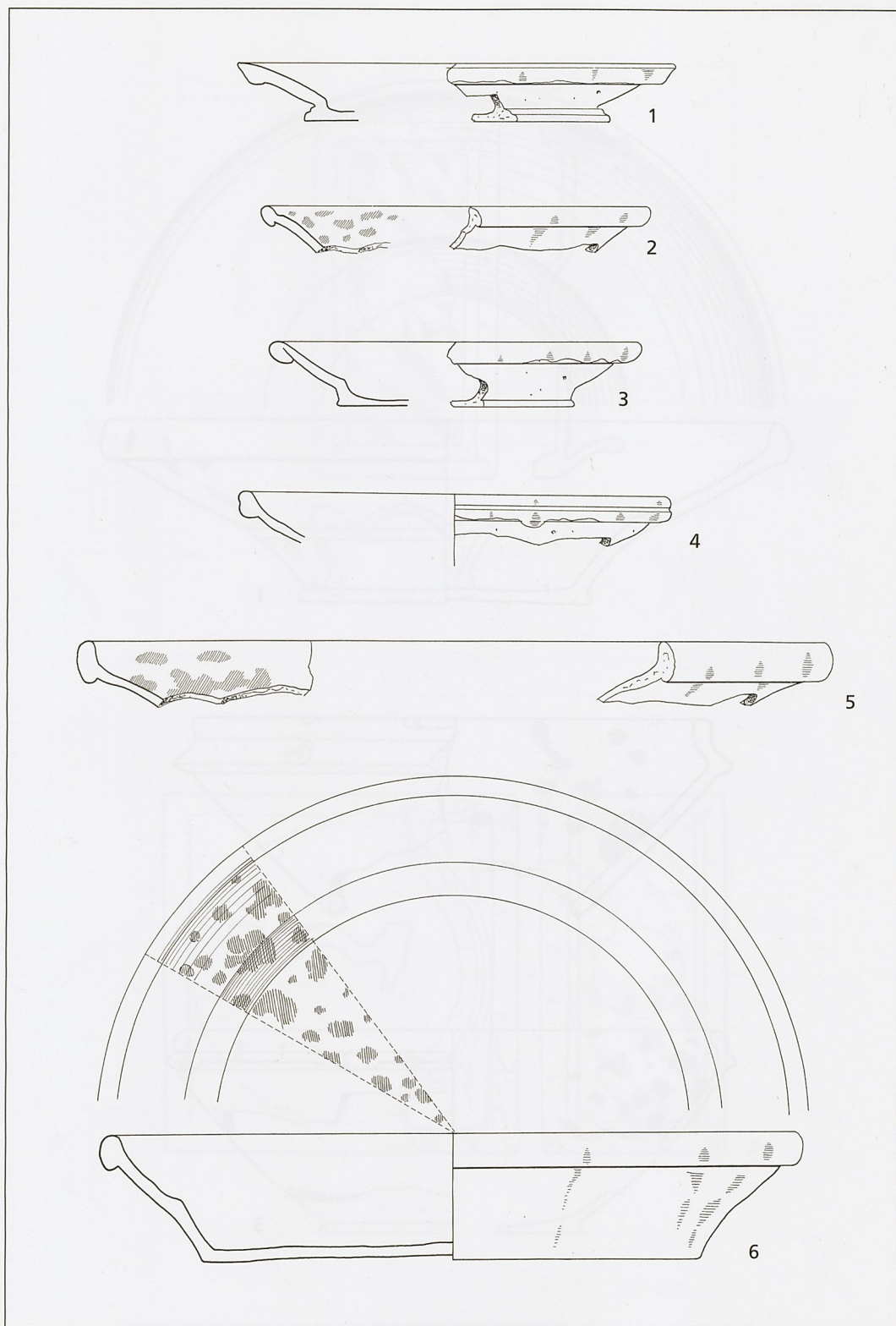

Neuhausen auf den Fildern (Lkr. Esslingen). Fdst. 3. M 1 : 3.

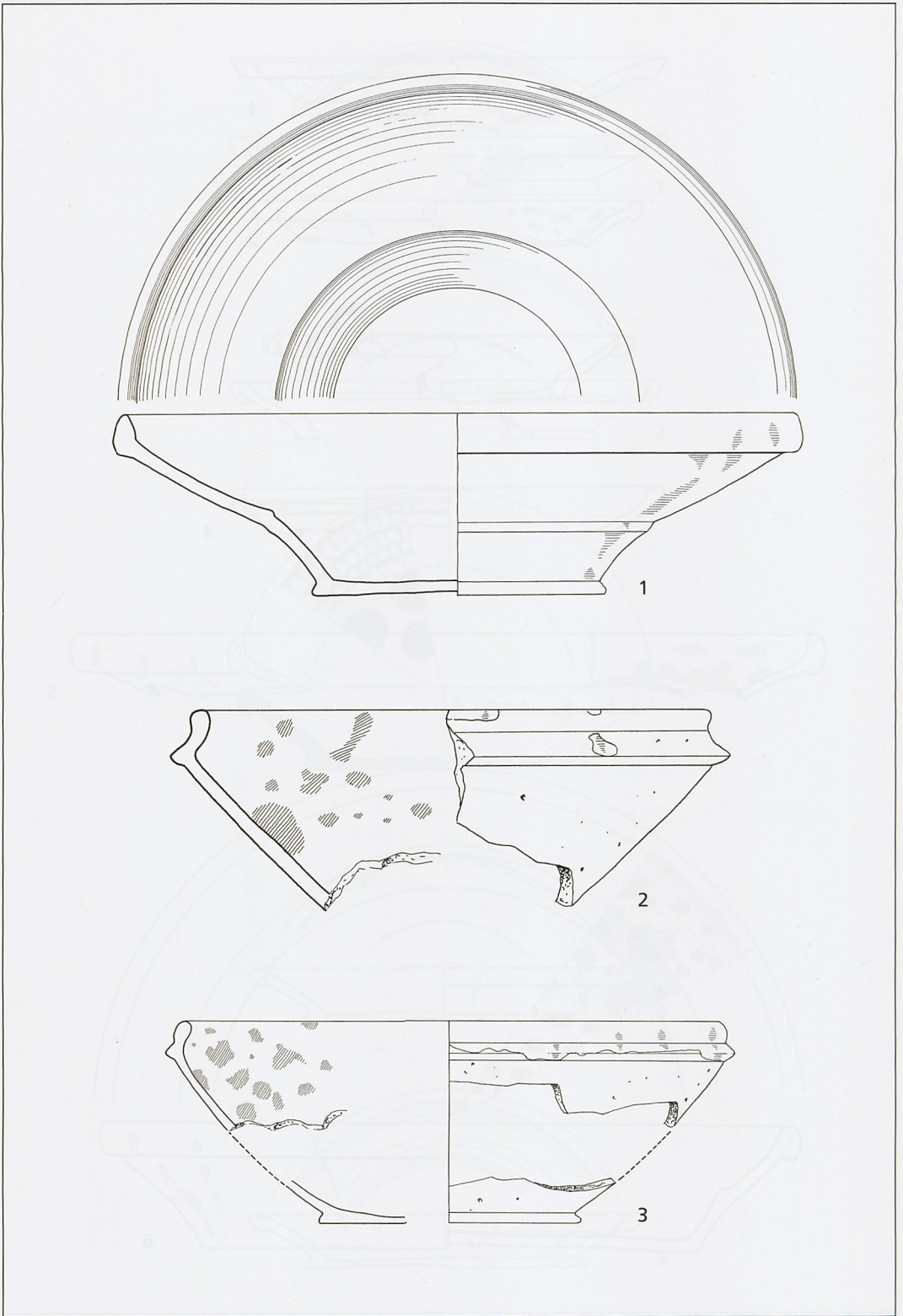

Neuhausen auf den Fildern (Lkr. Esslingen). Fdst. 3. M 1 : 3.

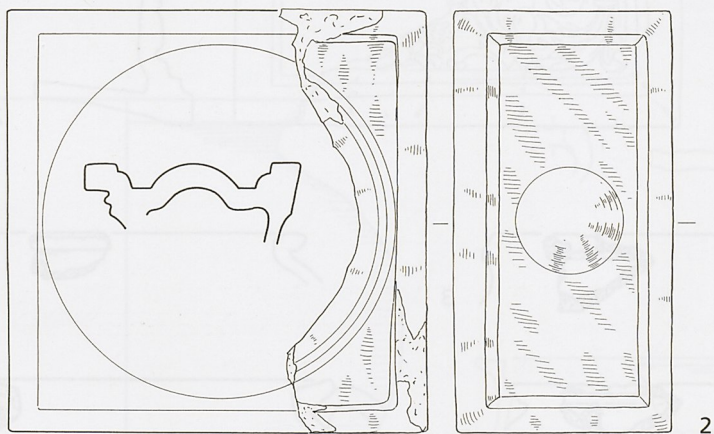
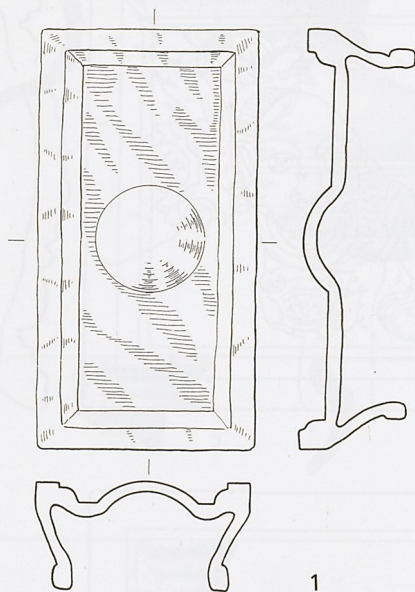

Neuhausen auf den Fildern (Lkr. Esslingen). Fdst. 3. M 1 : 3.

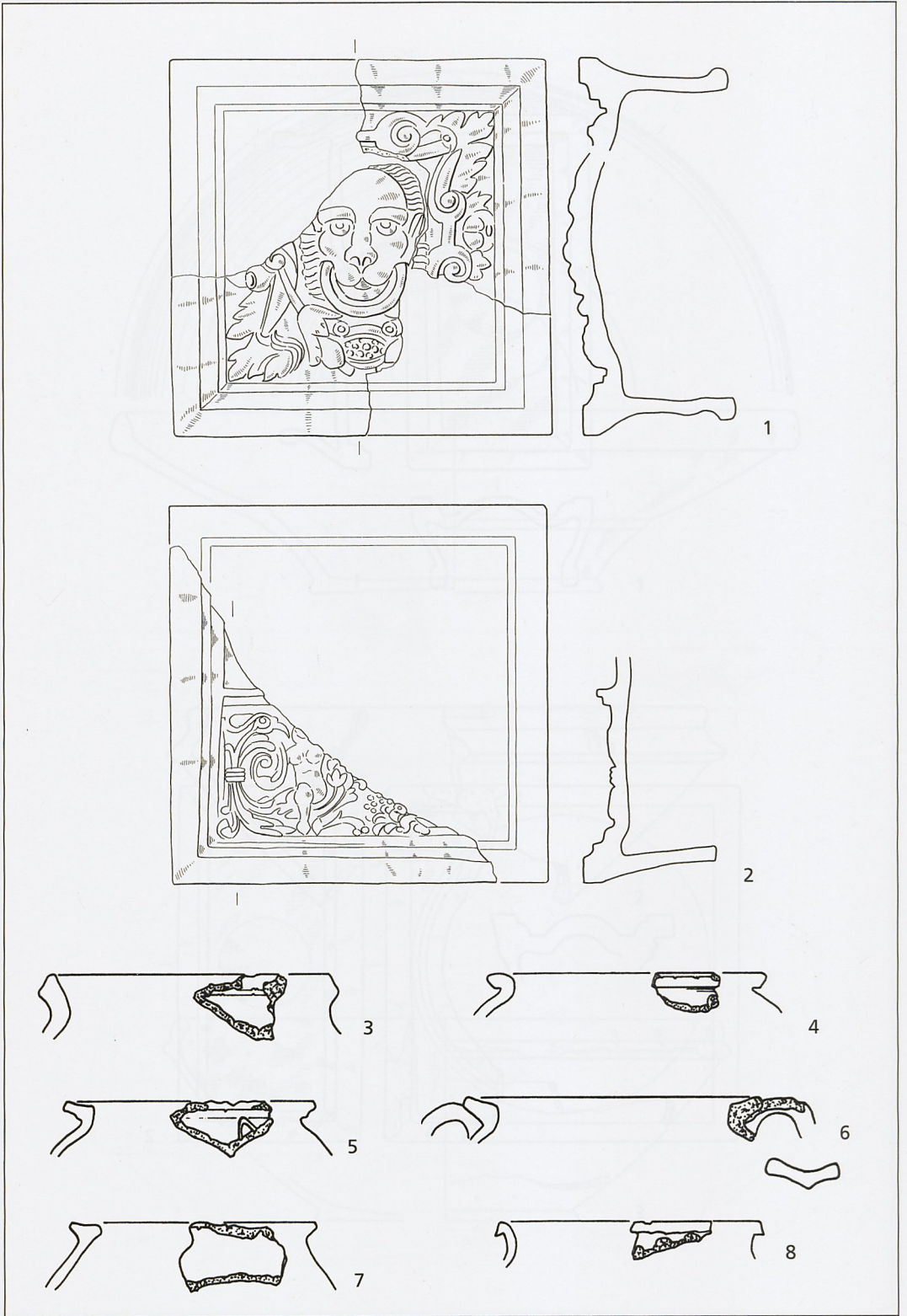

Neuhausen auf den Fildern (Lkr. Esslingen). 1.2 Fdst. 3; 3-8 Fdst. 4. M 1 : 3.

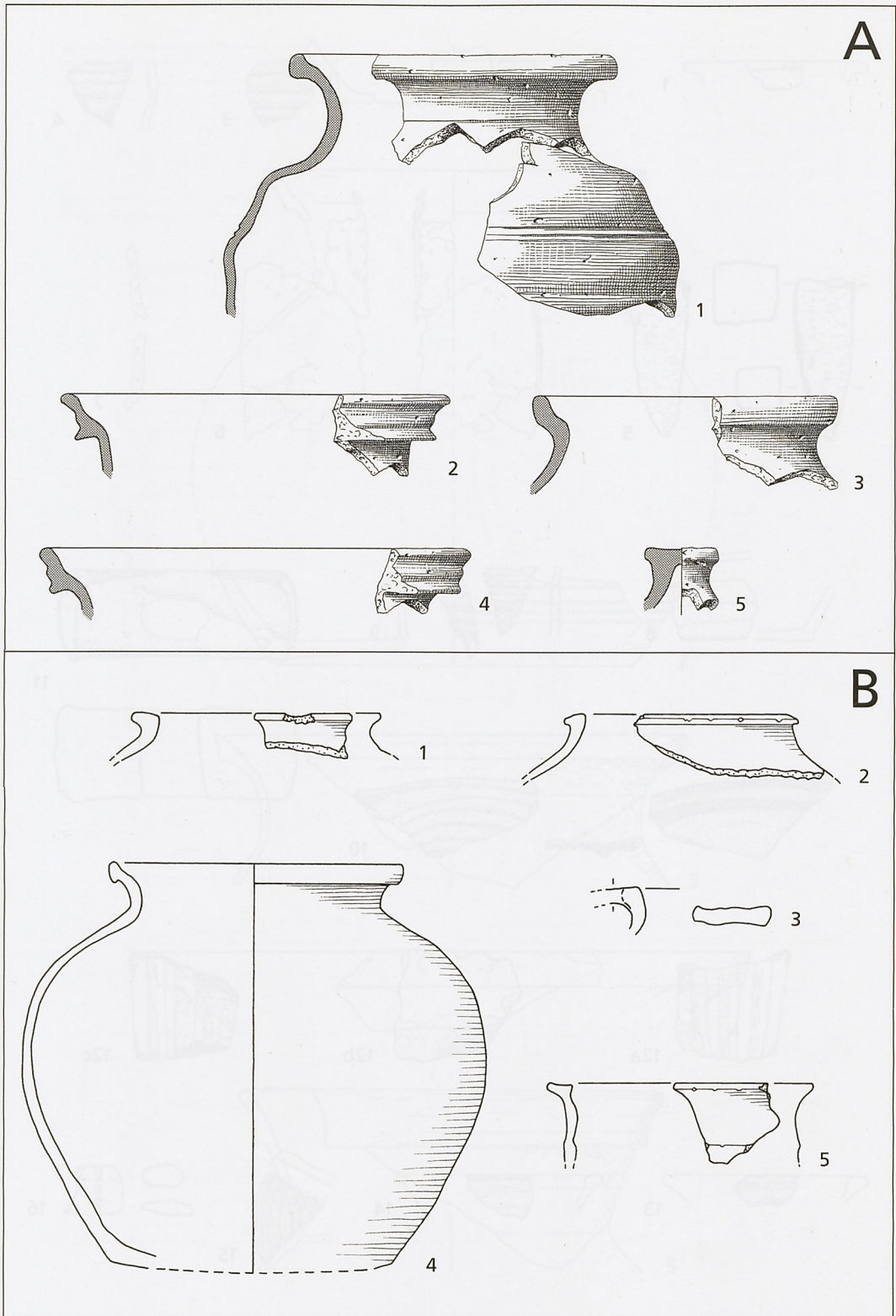

A Niederstetten Adolzhausen (Main-Tauber-Kreis). M 1 : 3. –
 B Nußloch (Rhein-Neckar-Kreis). M 1 : 3.

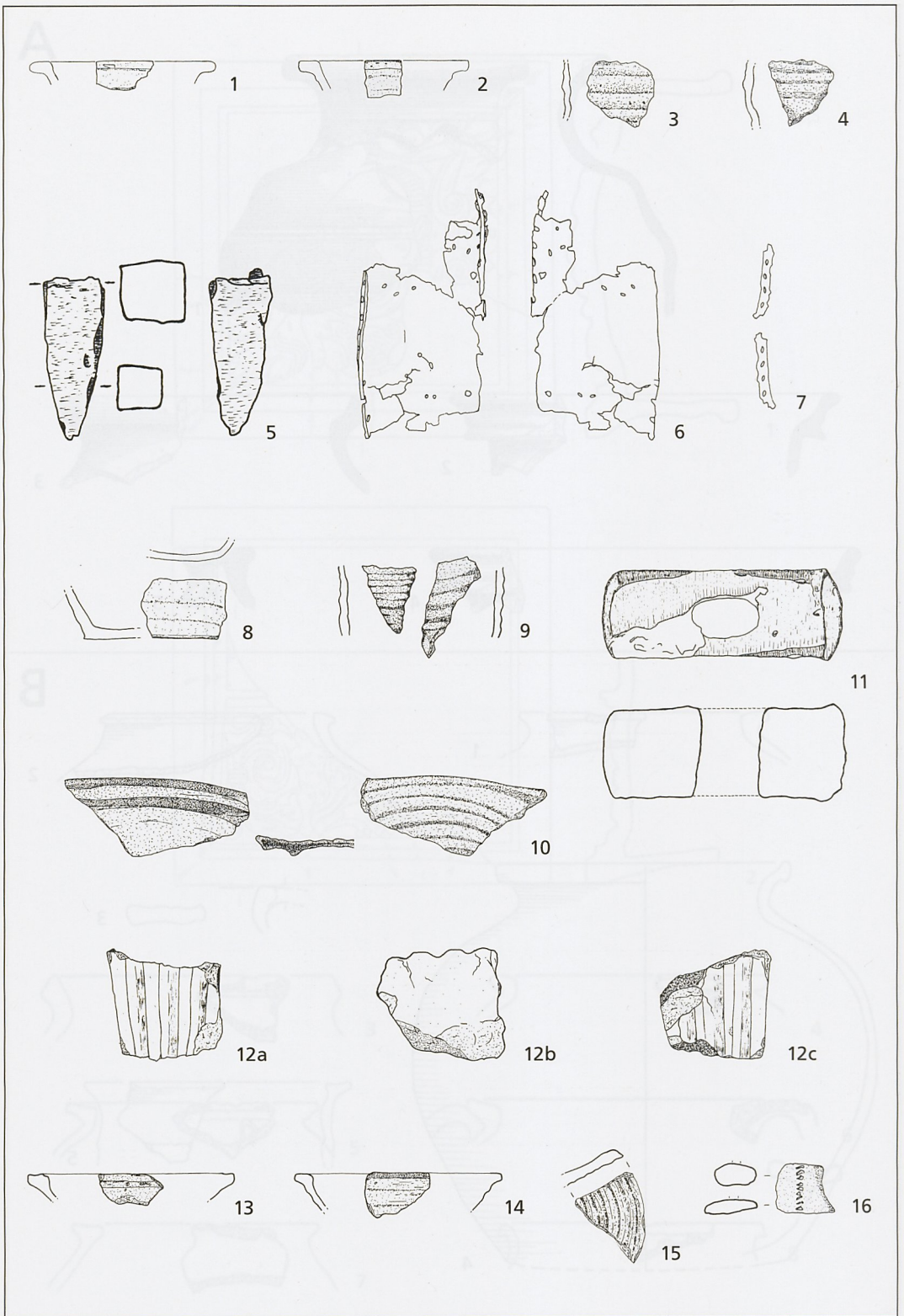

Oberried Hofsgrund (Kr. Breisgau-Hochschwarzwald). M 1 : 3; 5 M 1 : 2.

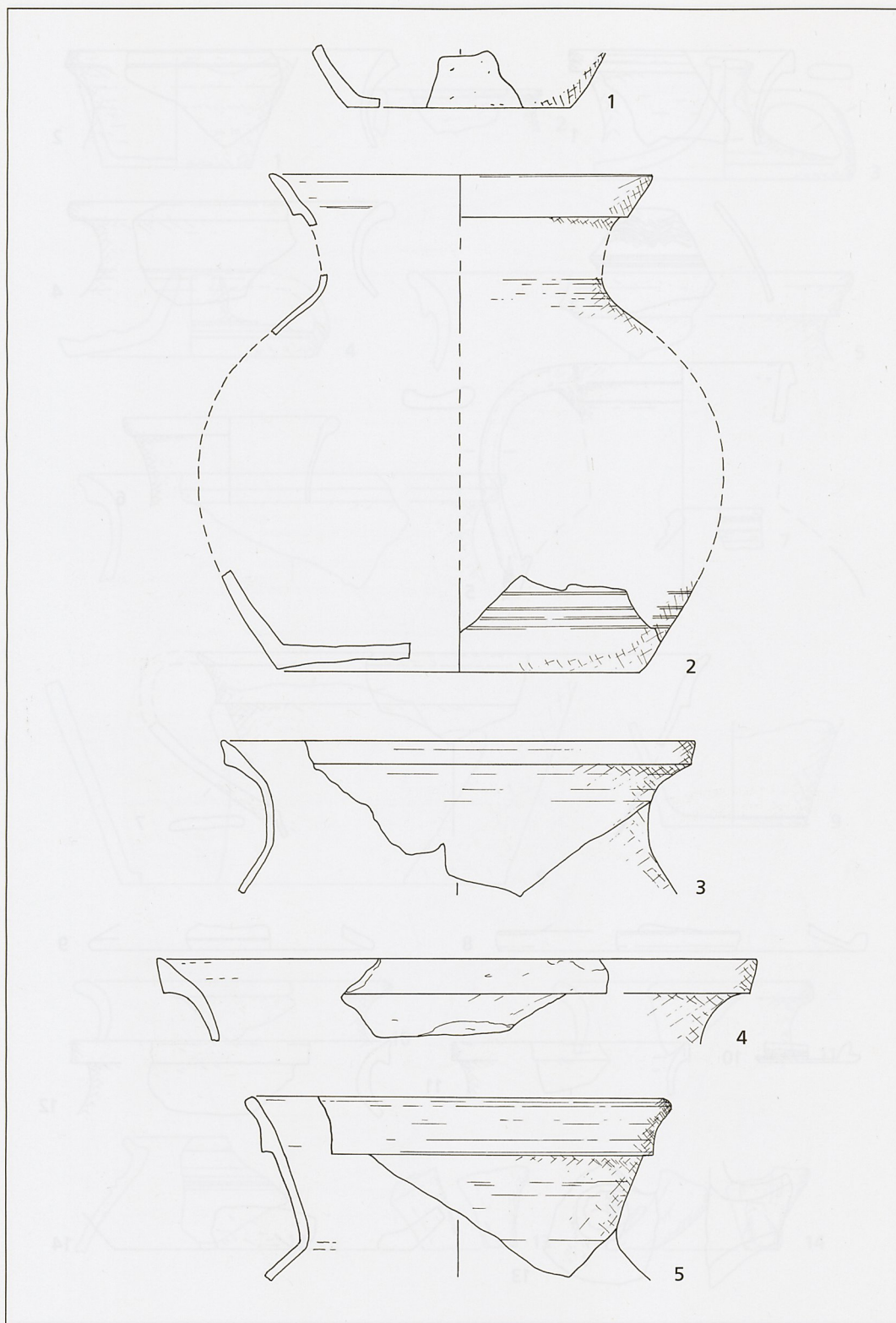

Ottenhöfen im Schwarzwald (Ortenaukreis). M 1 : 3.

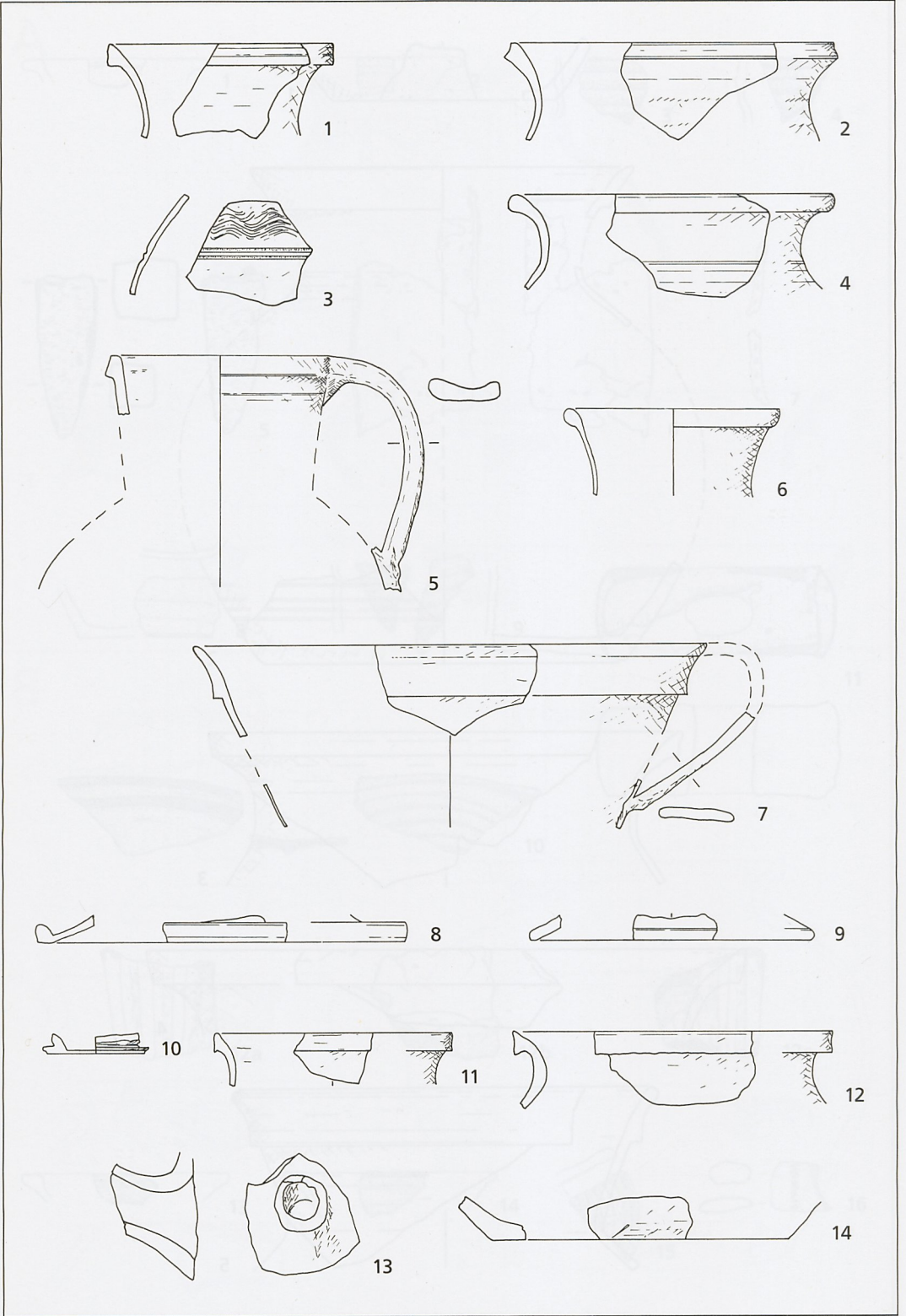

Ottenhöfen im Schwarzwald (Ortenaukreis). M 1 : 3.

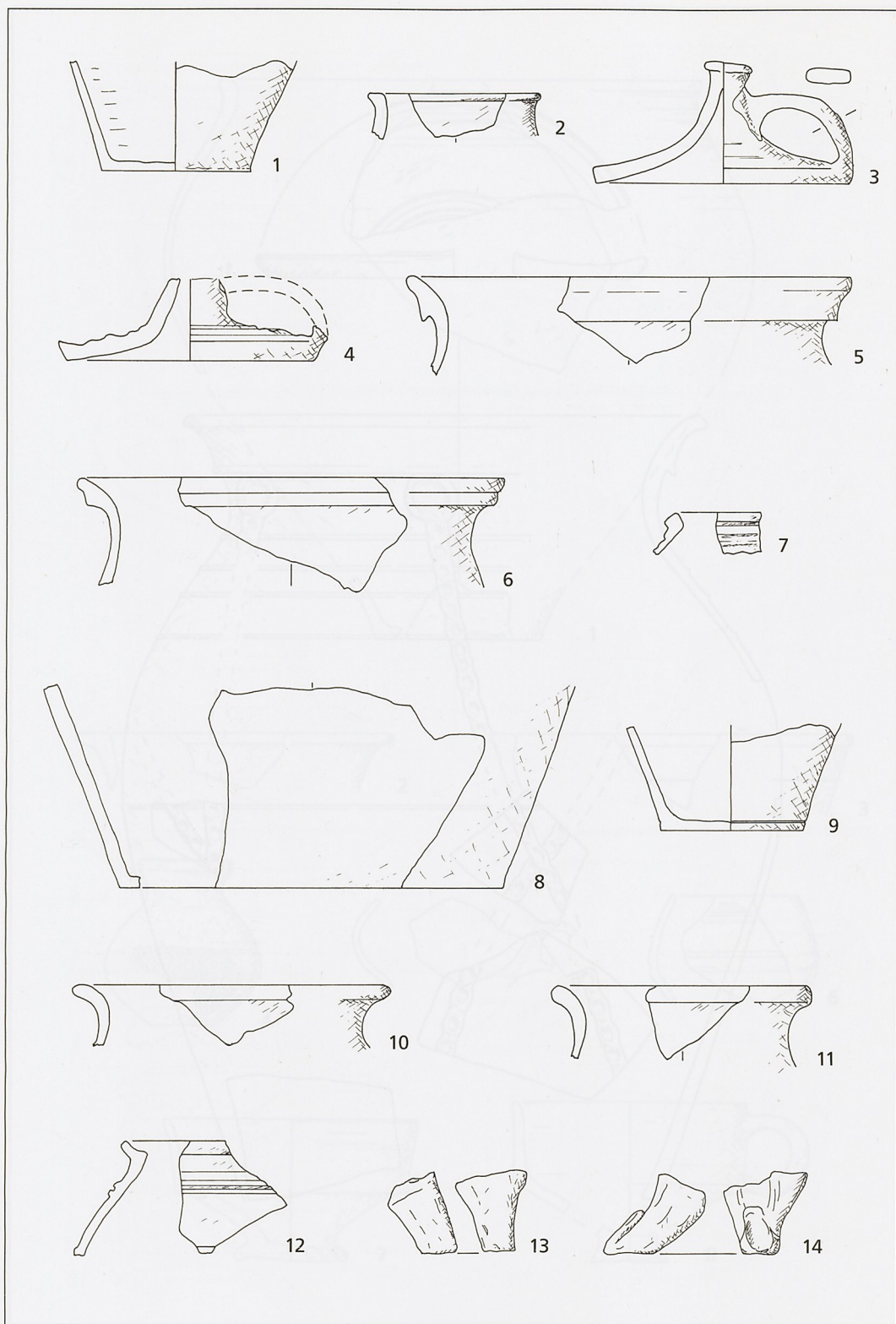

Ottenhöfen im Schwarzwald (Ortenaukreis). M 1 : 3.

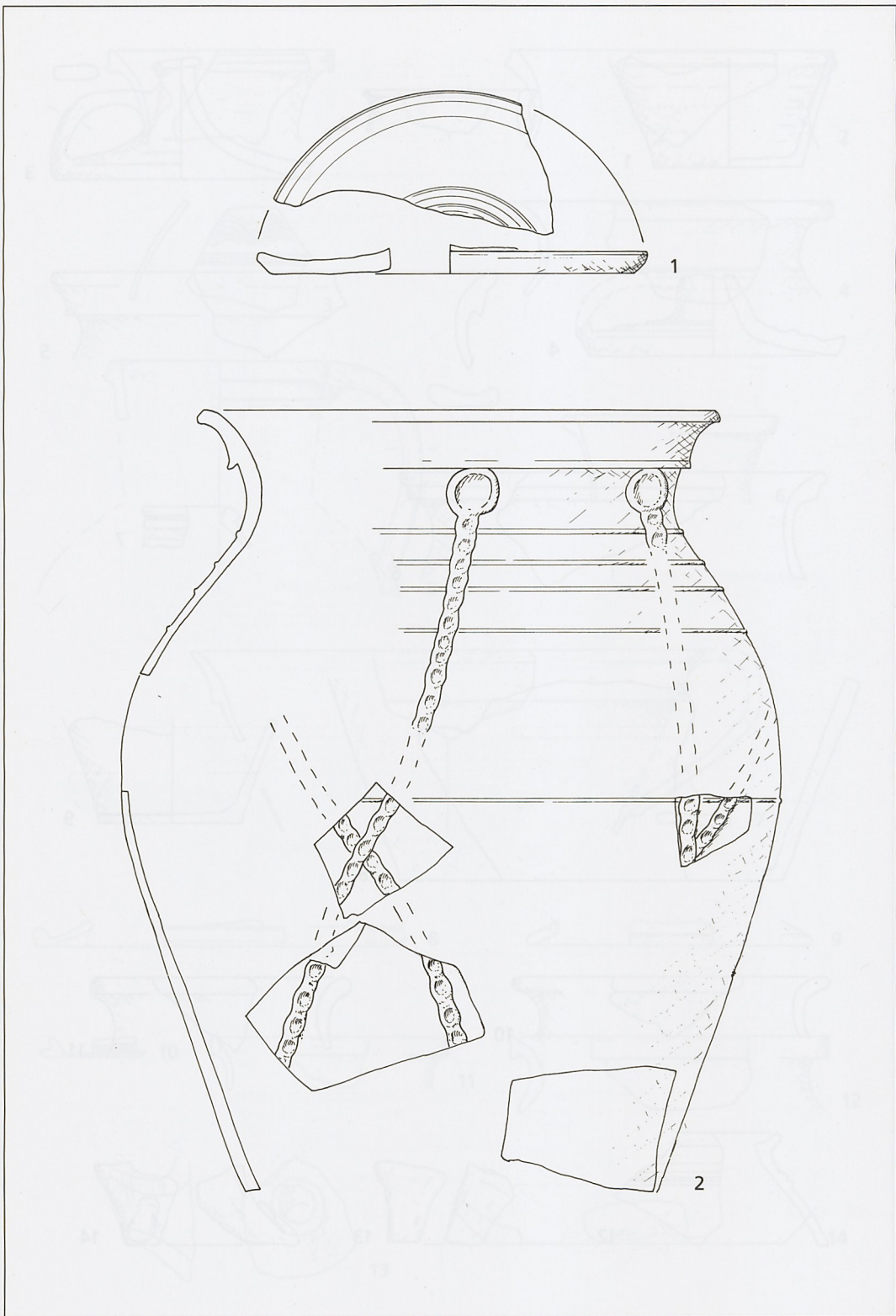

Ottenhöfen im Schwarzwald (Ortenaukreis). M 1 : 3.

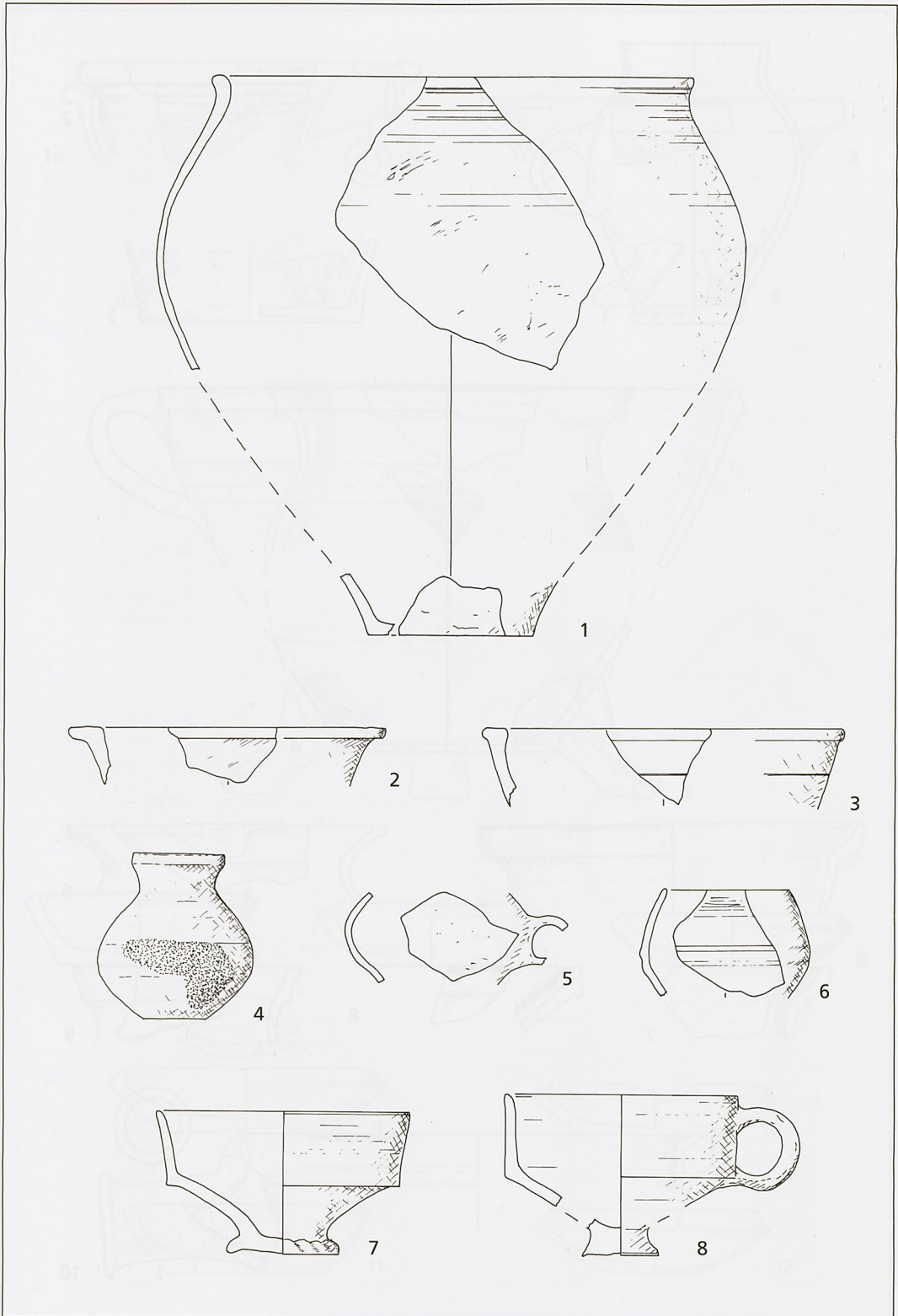

Ottenhöfen im Schwarzwald (Ortenaukreis). M 1 : 3.

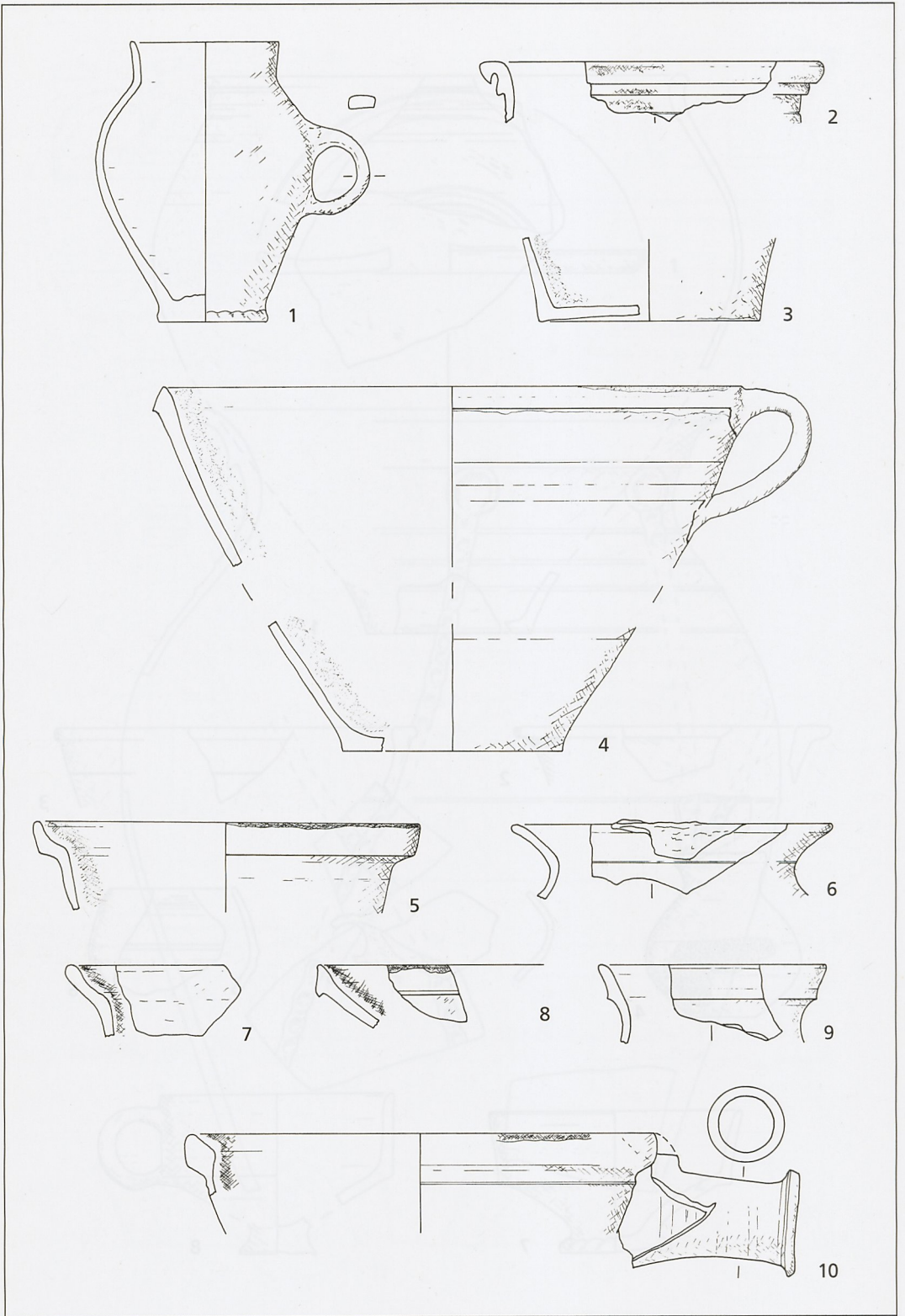

Ottenhöfen im Schwarzwald (Ortenaukreis). M 1 : 3.

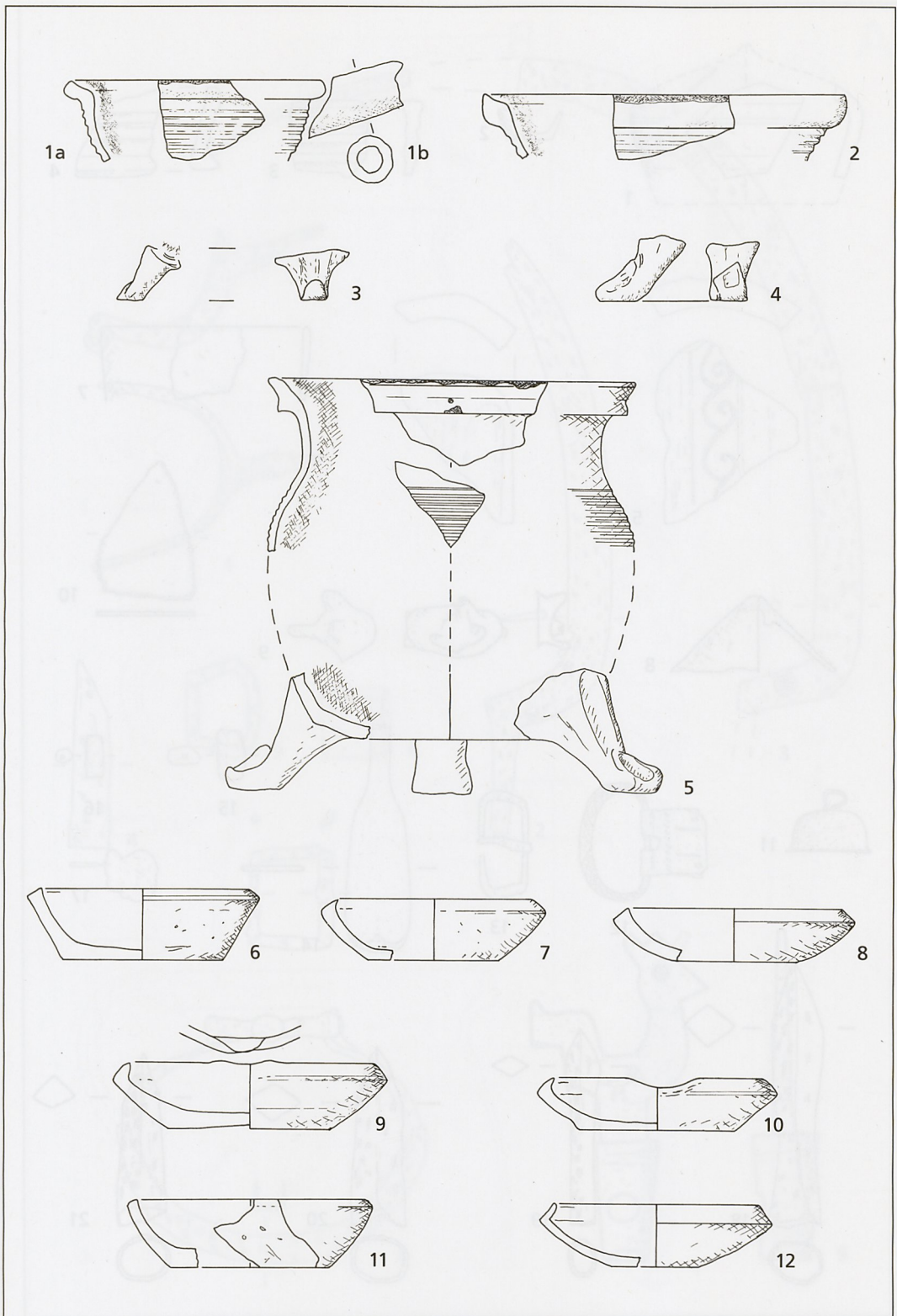

Ottenhöfen im Schwarzwald (Ortenaukreis). M 1 : 3.

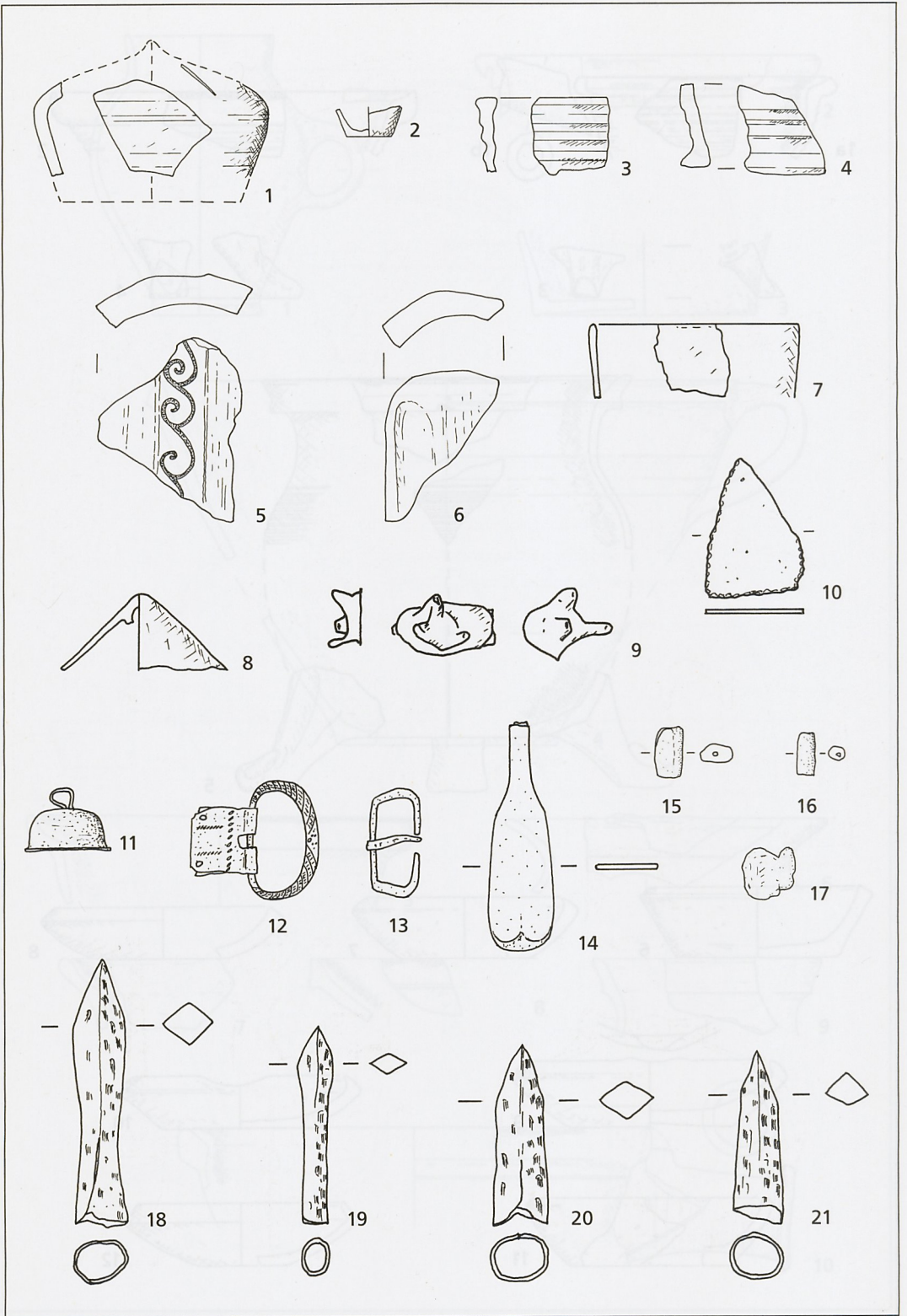

Ottenhöfen im Schwarzwald (Ortenaukreis). M 1 : 3; 7-21 M 1 : 2.

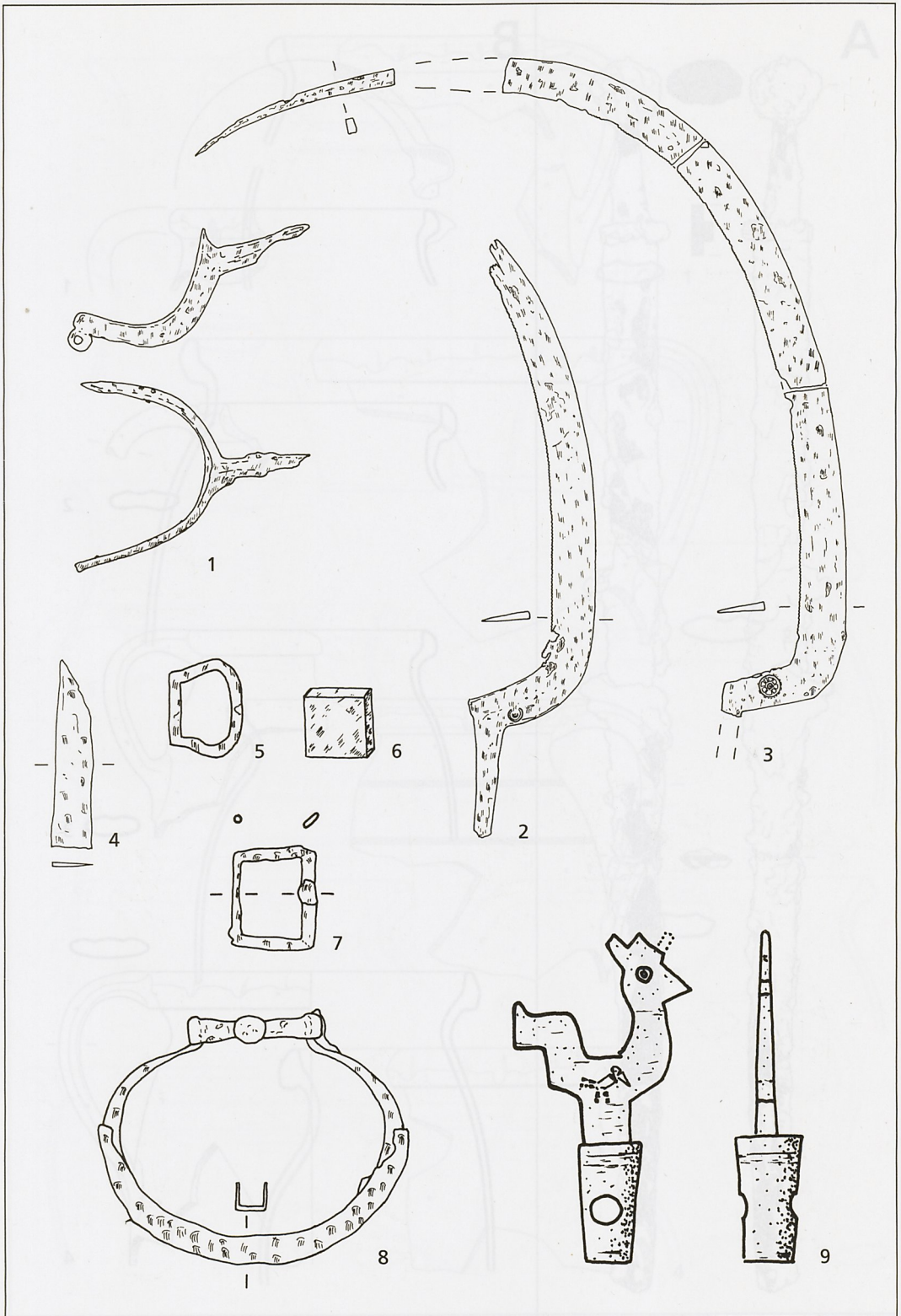

Ottenhöfen im Schwarzwald (Ortenaukreis). M 1 : 3.

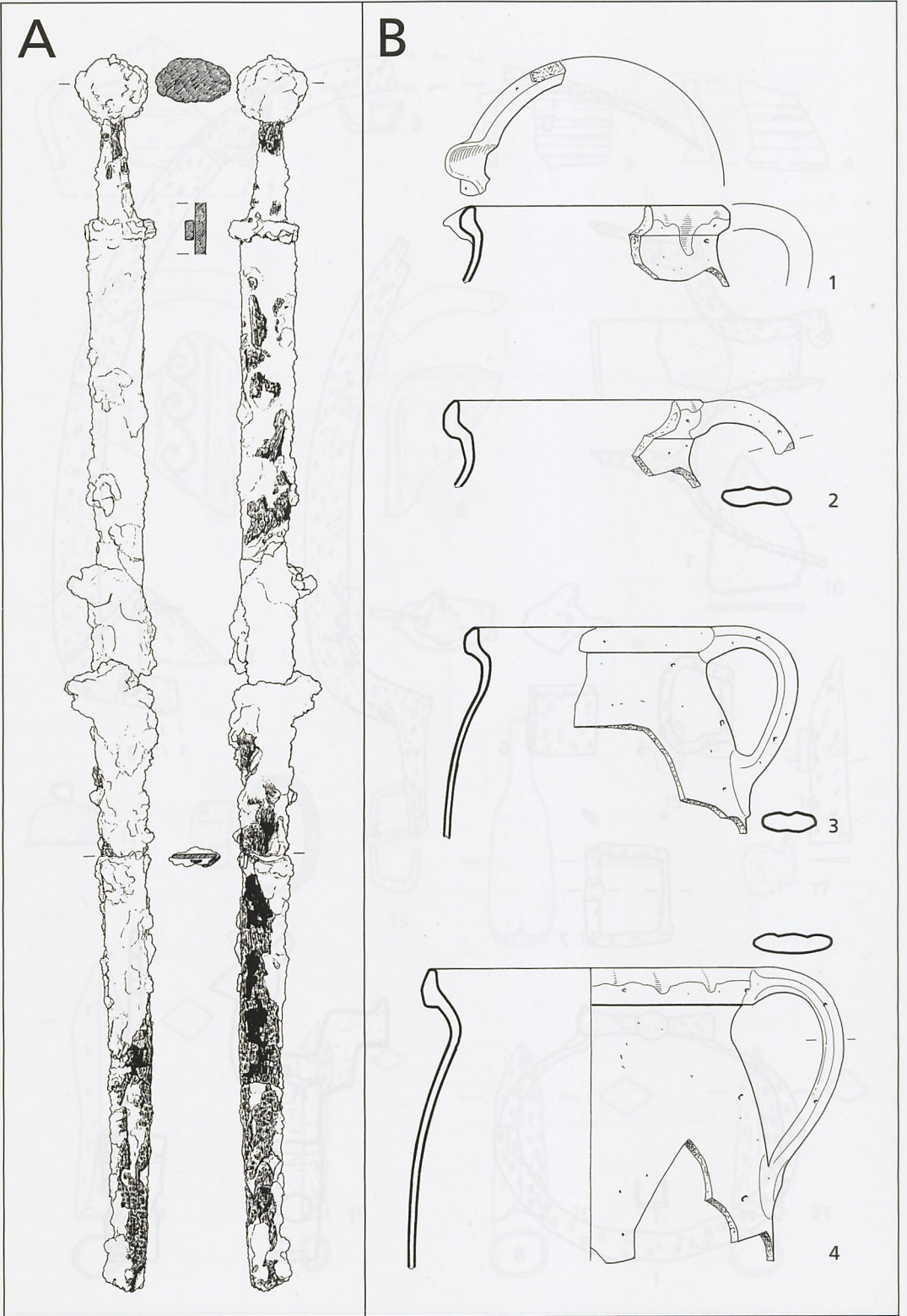

A Rottweil (Lkr. Rottweil). M 1 : 6. – B Schwäbisch Hall (Lkr. Schwäbisch Hall). M 1 : 3.

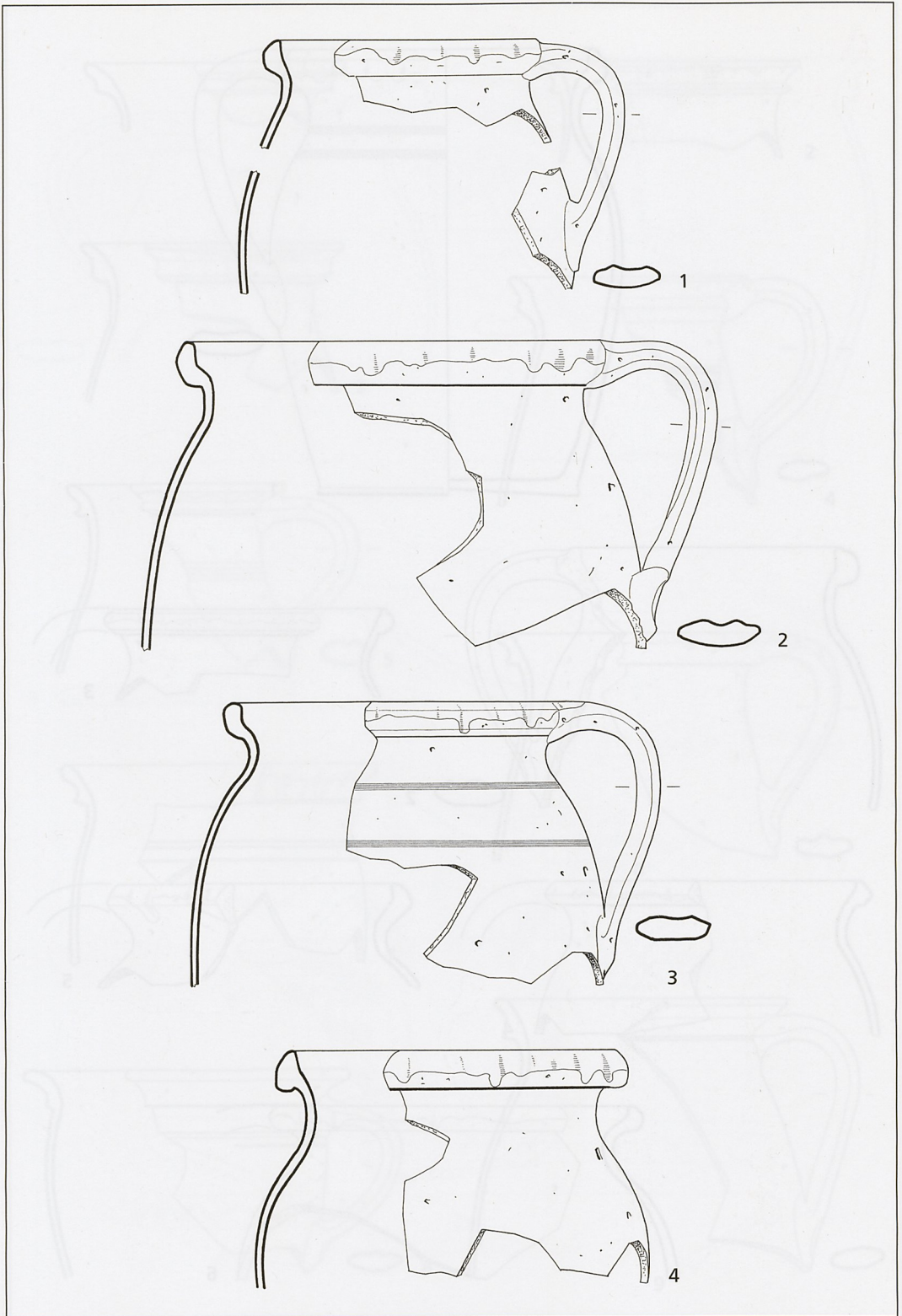

Schwäbisch Hall (Lkr. Schwäbisch Hall). M 1 : 3.

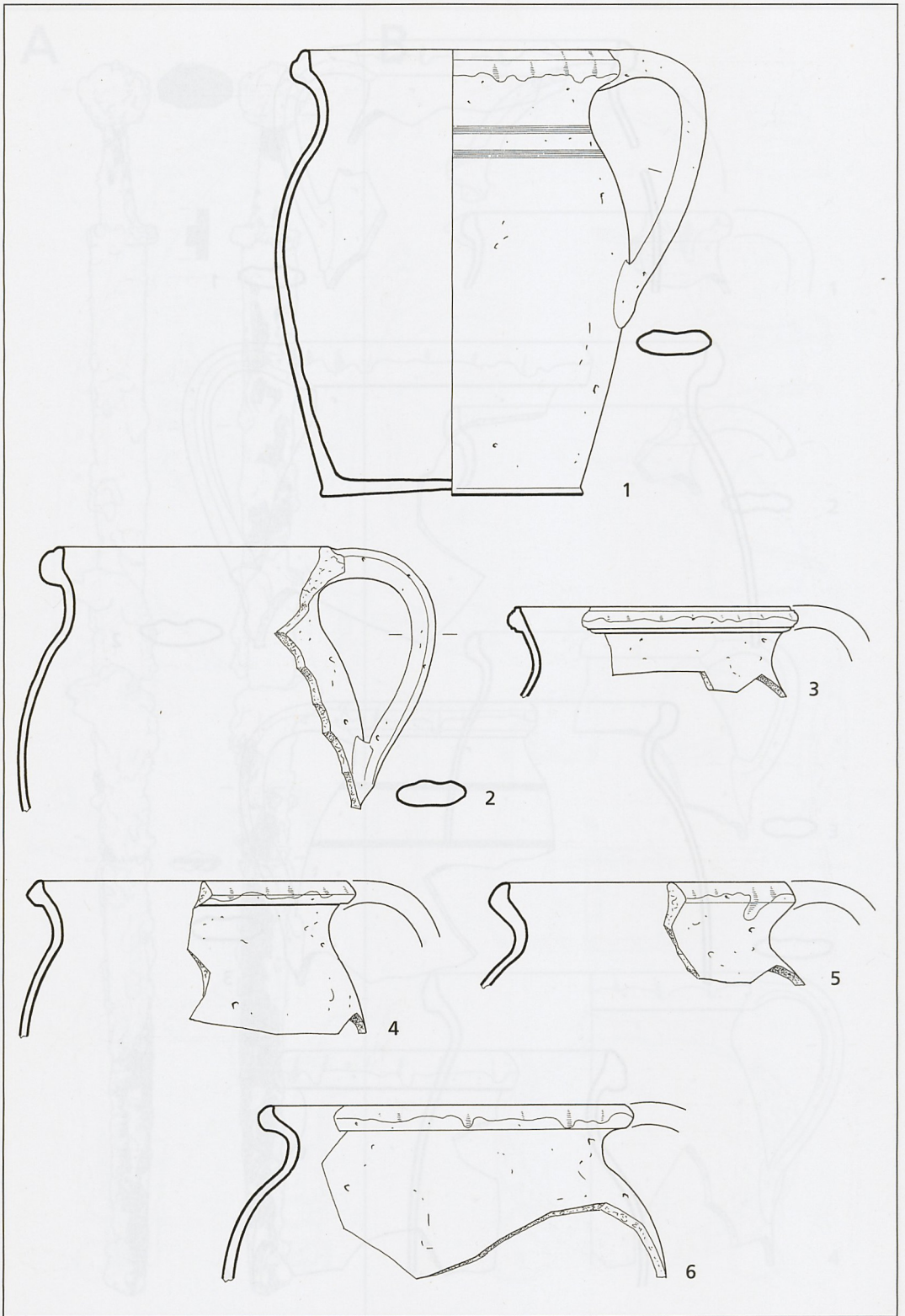

Schwäbisch Hall (Lkr. Schwäbisch Hall). M 1 : 3.

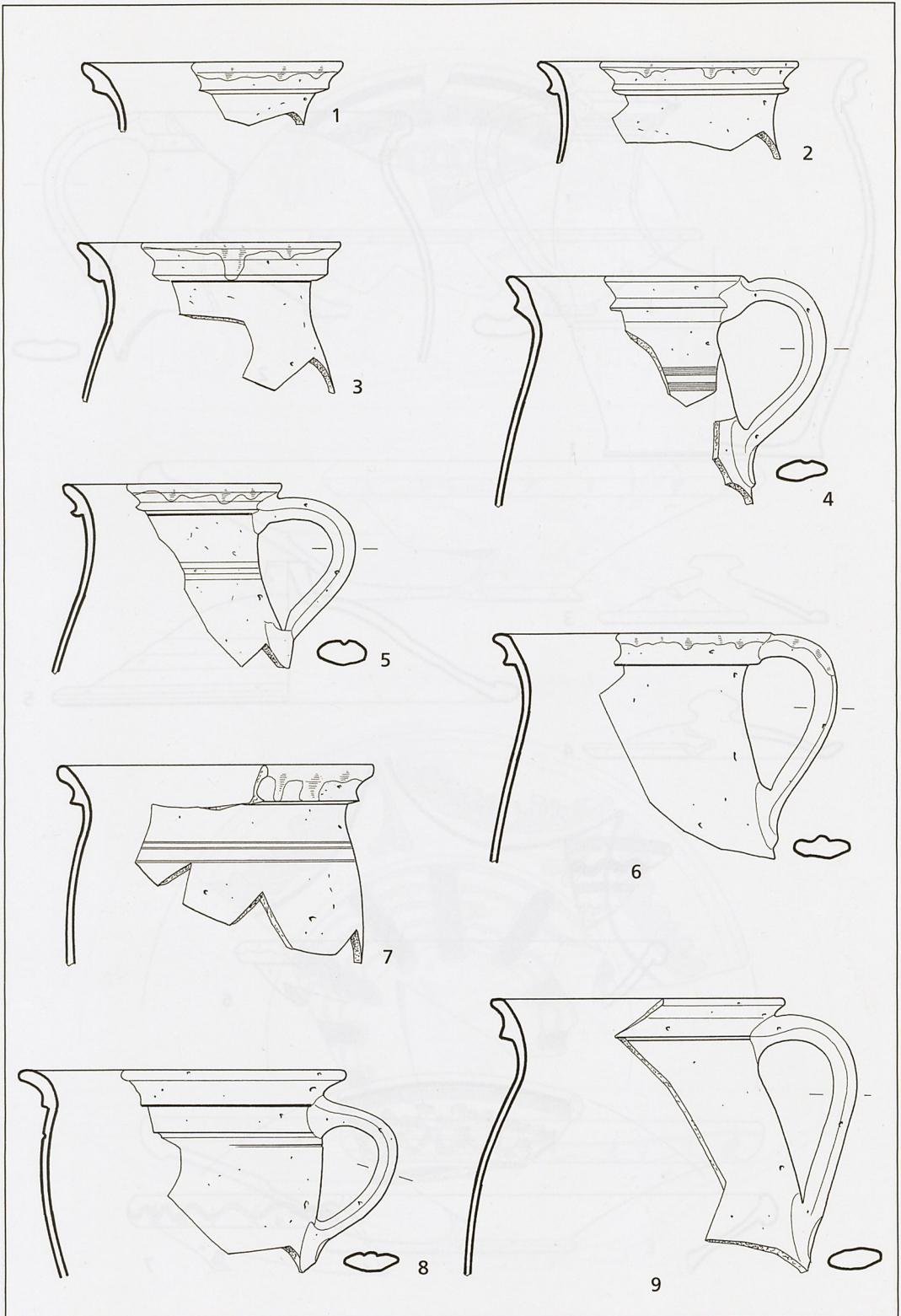

Schwäbisch Hall (Lkr. Schwäbisch Hall). M 1 : 3.

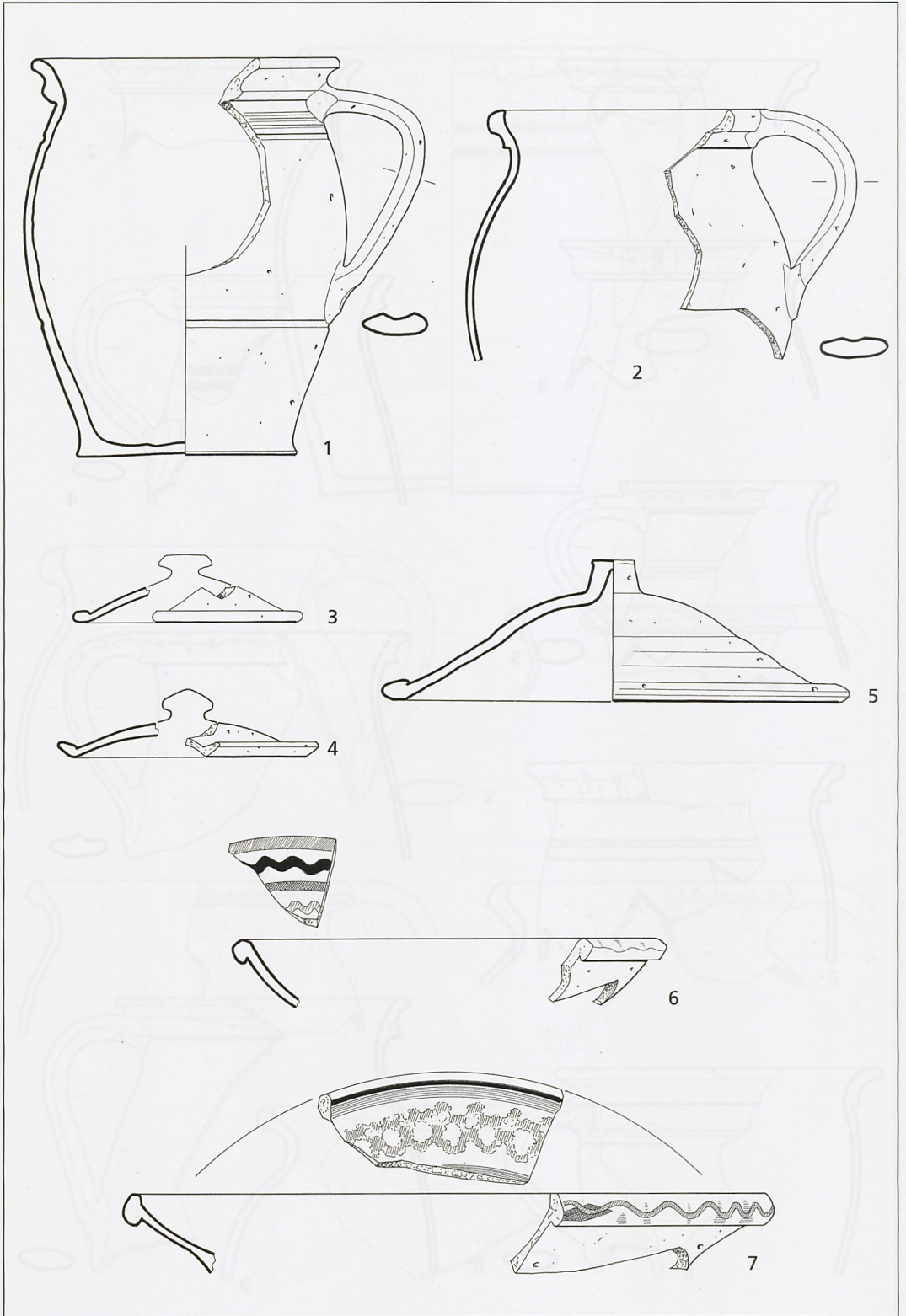

Schwäbisch Hall (Lkr. Schwäbisch Hall). M 1 : 3.

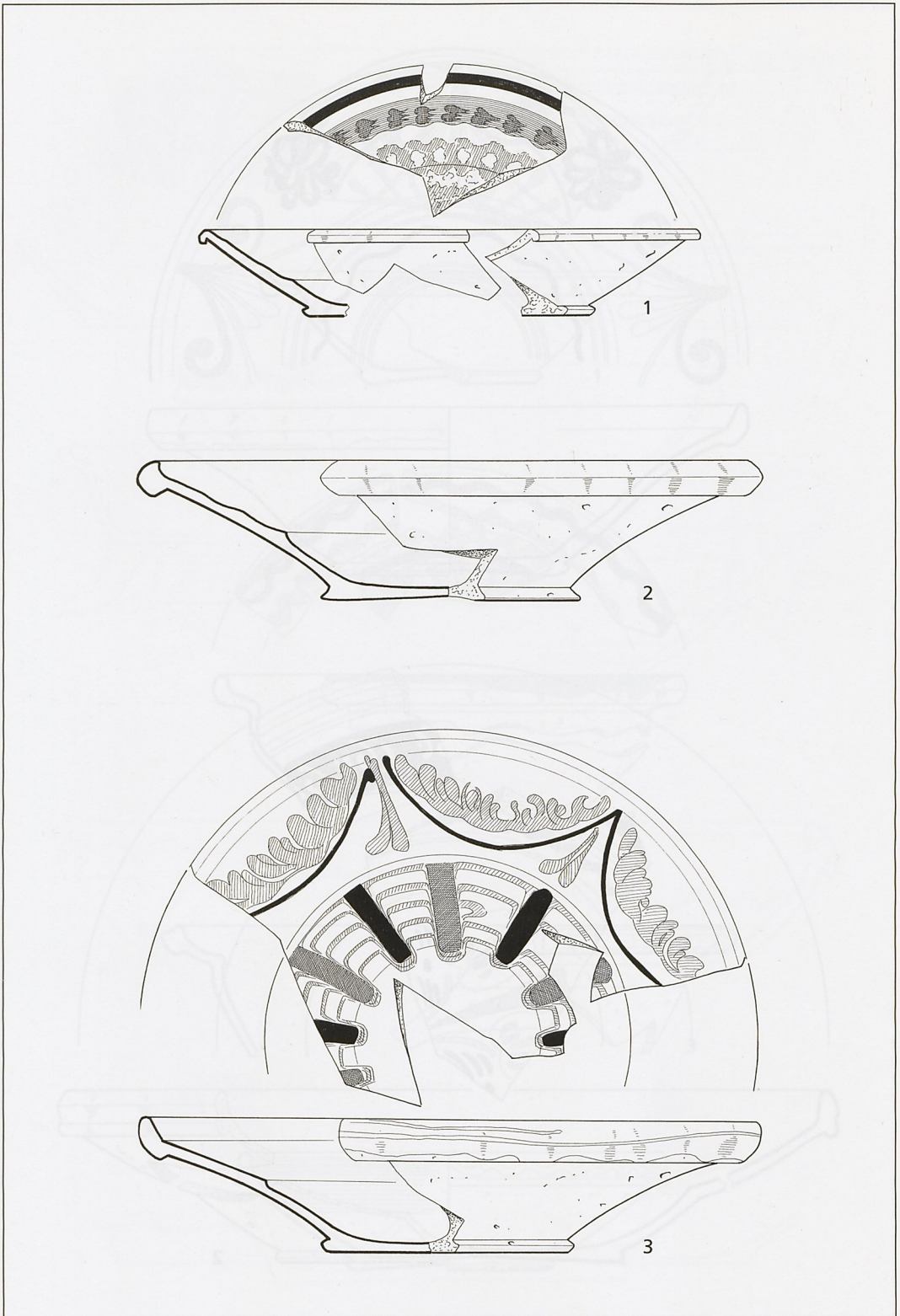

Schwäbisch Hall (Lkr. Schwäbisch Hall). M 1 : 3.

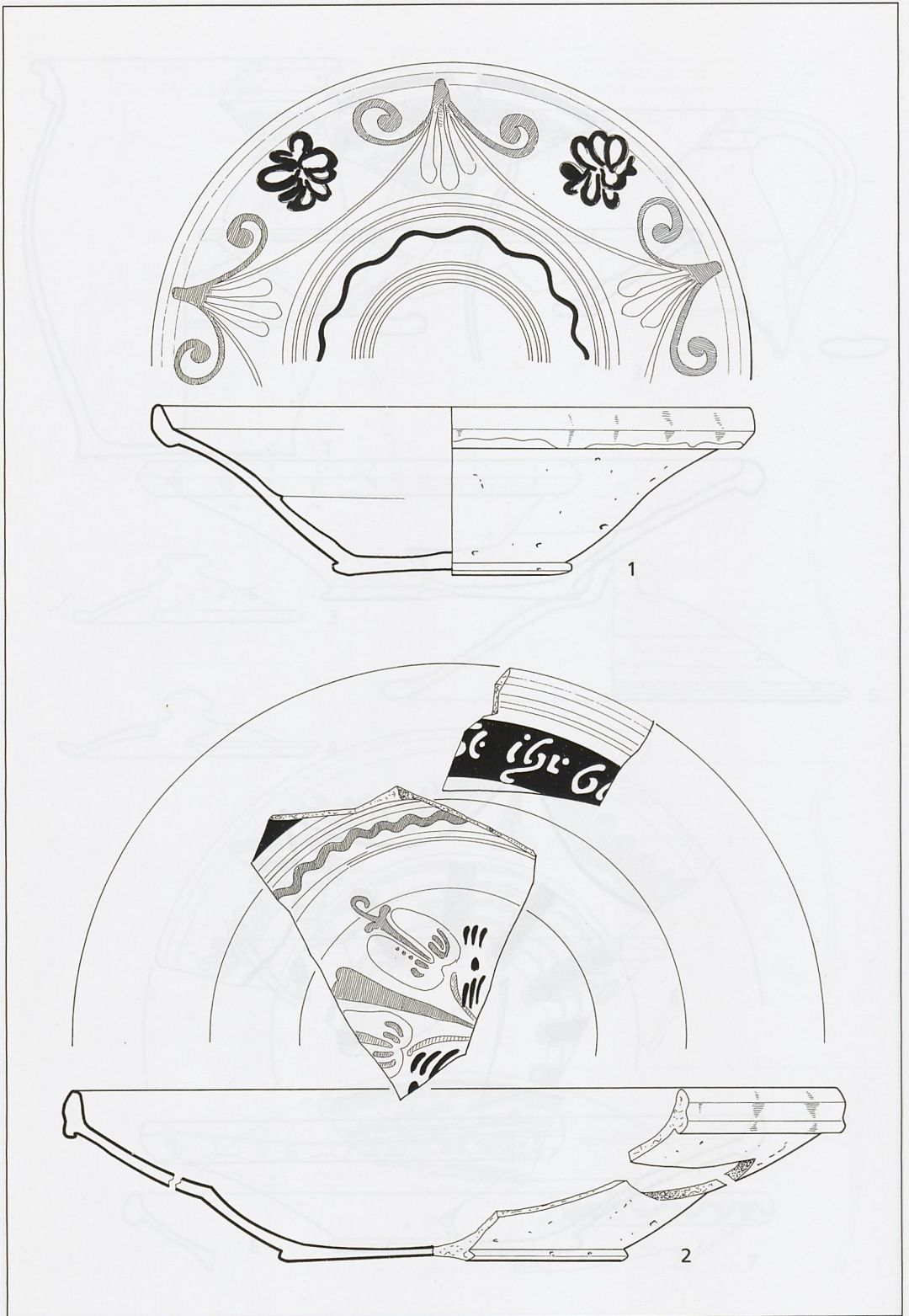

Schwäbisch Hall (Lkr. Schwäbisch Hall). M 1 : 3.

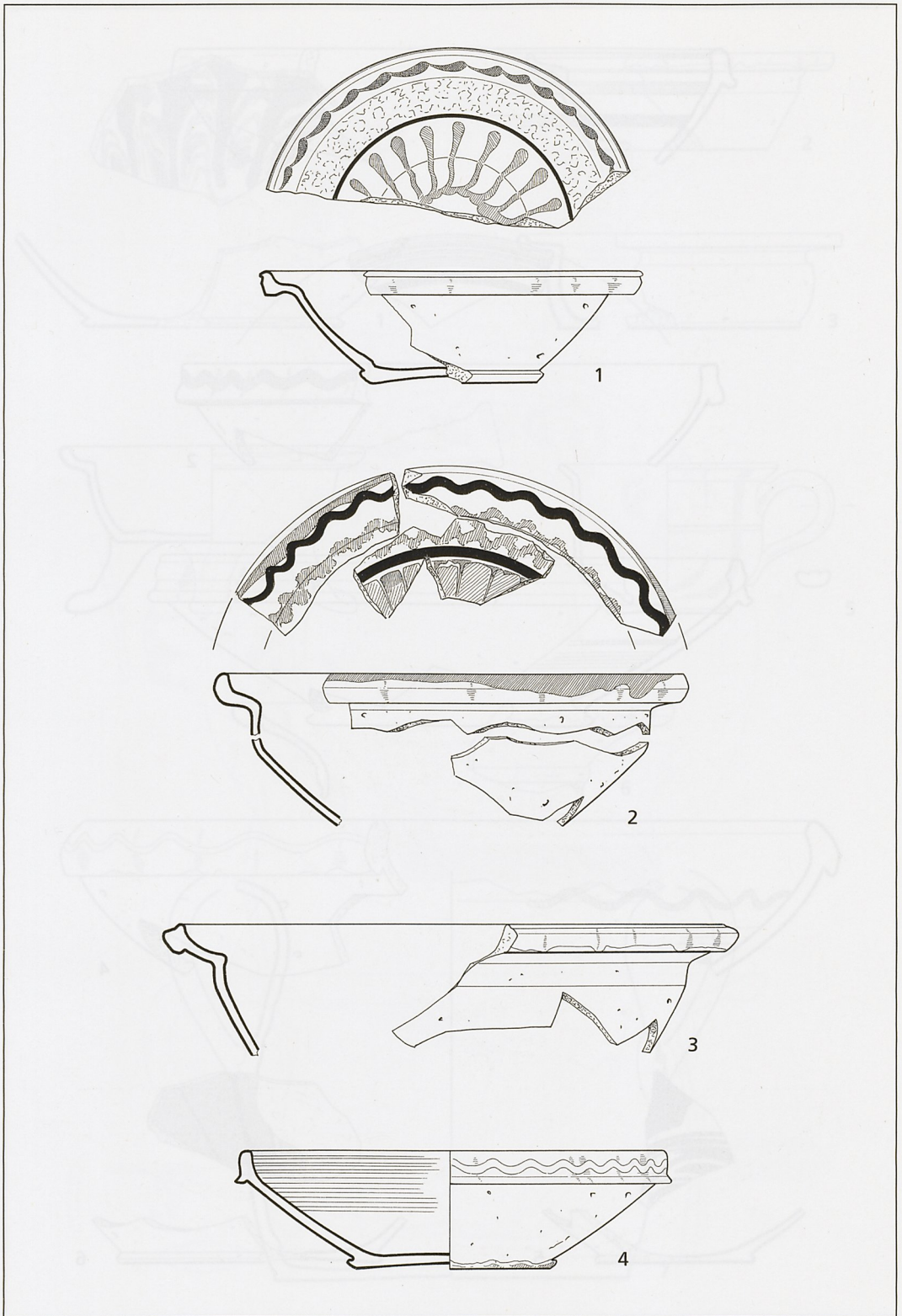

Schwäbisch Hall (Lkr. Schwäbisch Hall). M 1 : 3.

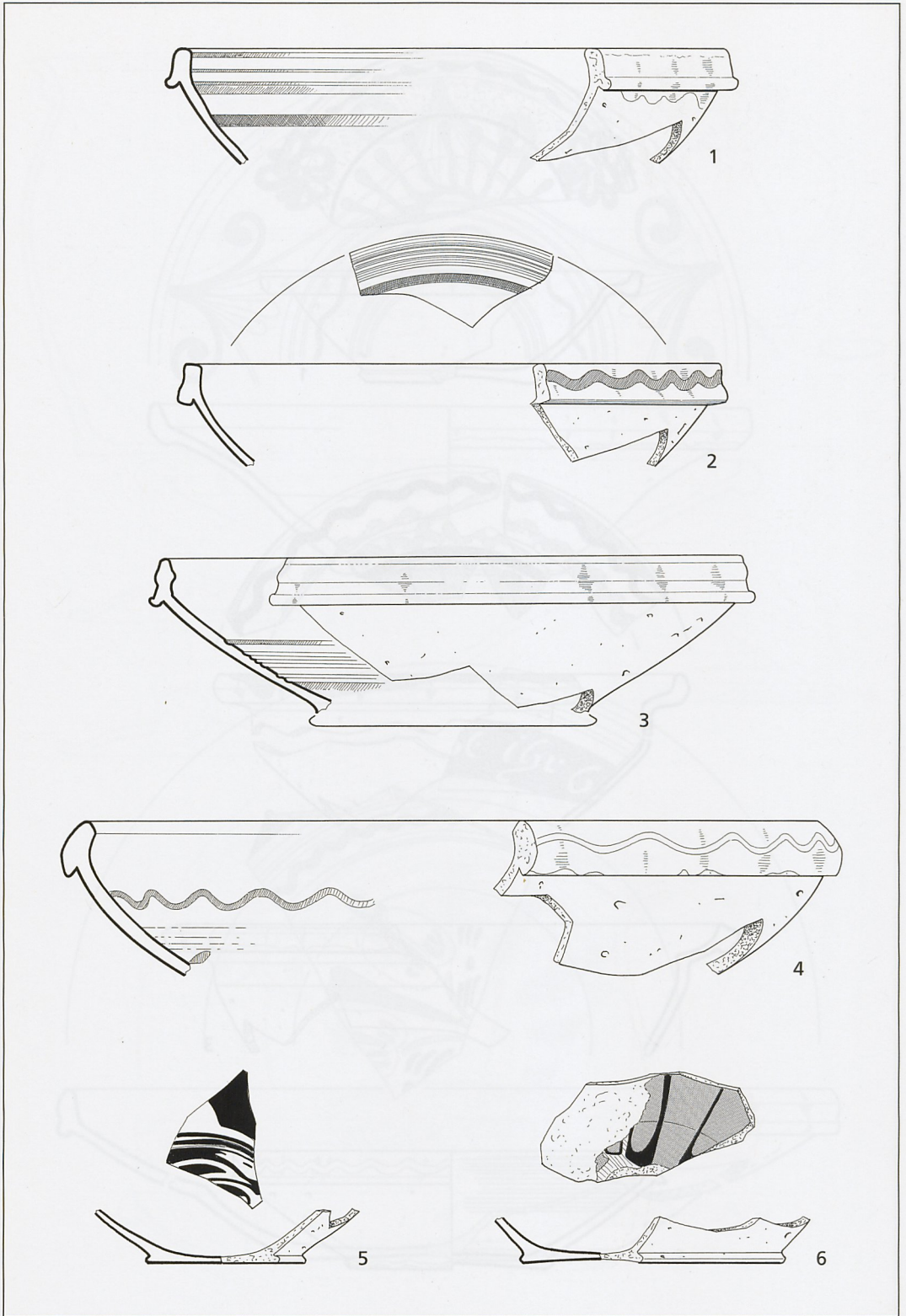

Schwäbisch Hall (Lkr. Schwäbisch Hall). M 1 : 3.

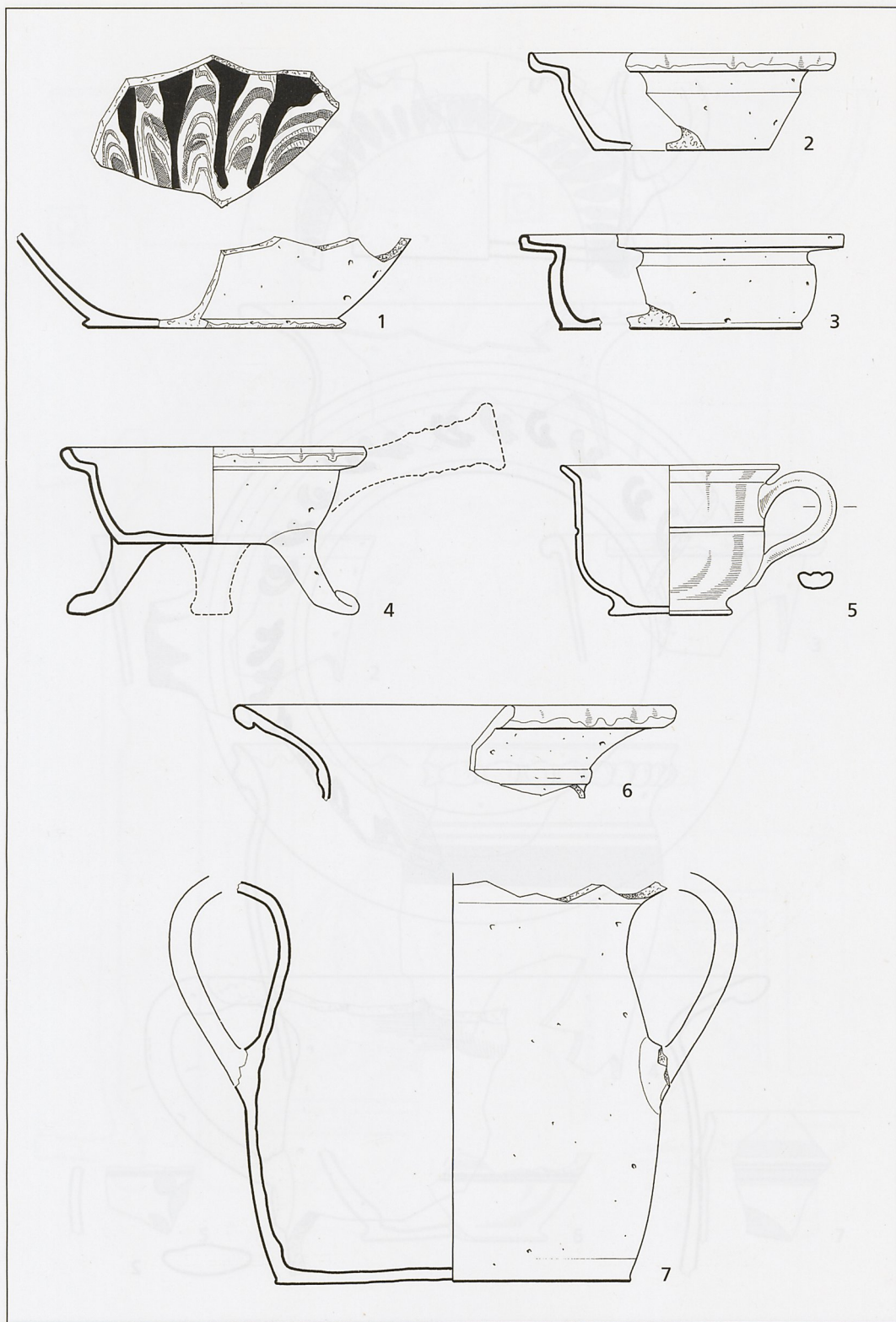

Schwäbisch Hall (Lkr. Schwäbisch Hall). M 1 : 3.

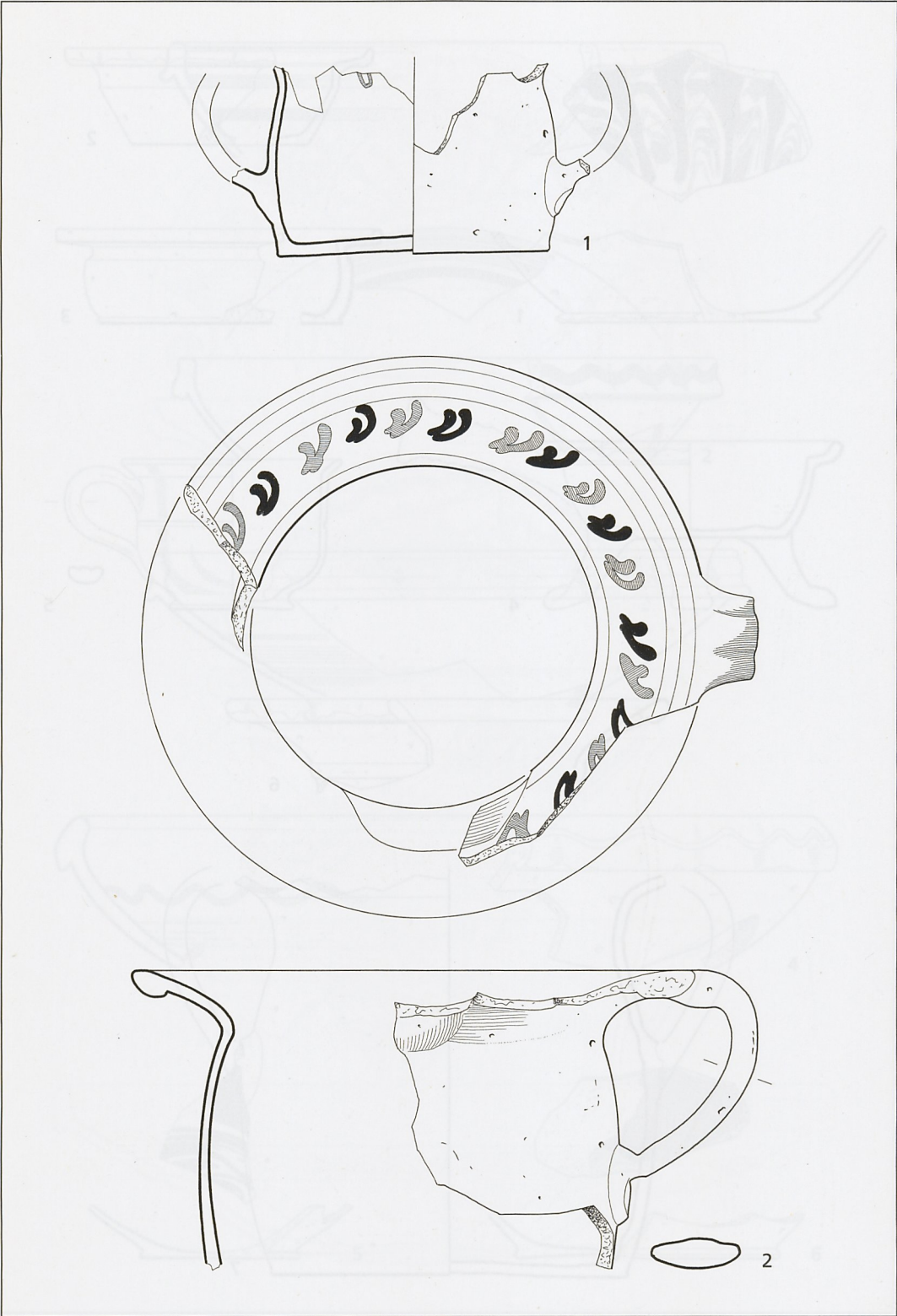

Schwäbisch Hall (Lkr: Schwäbisch Hall). M 1 : 3.

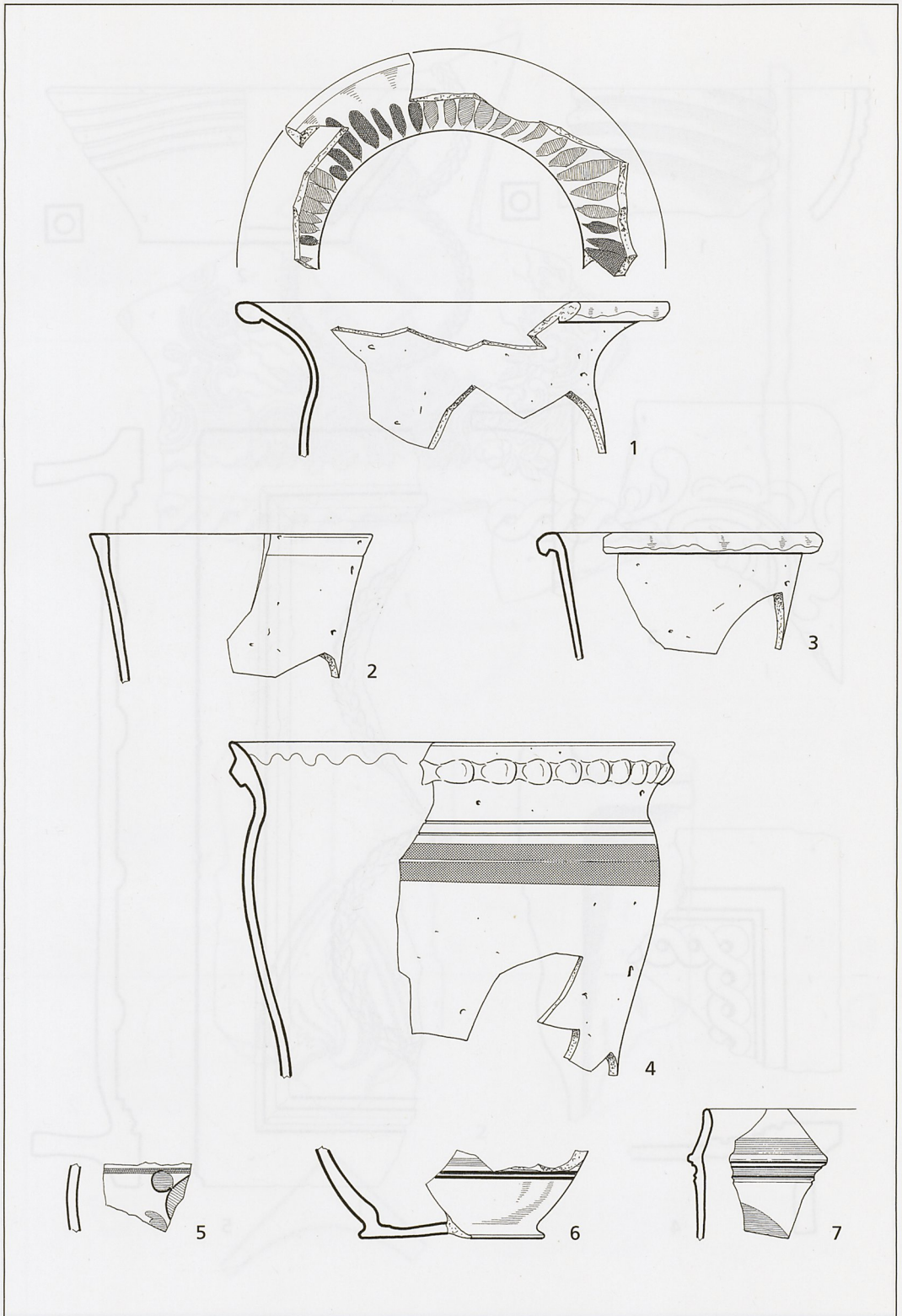

Schwäbisch Hall (Lkr. Schwäbisch Hall). M 1 : 3.

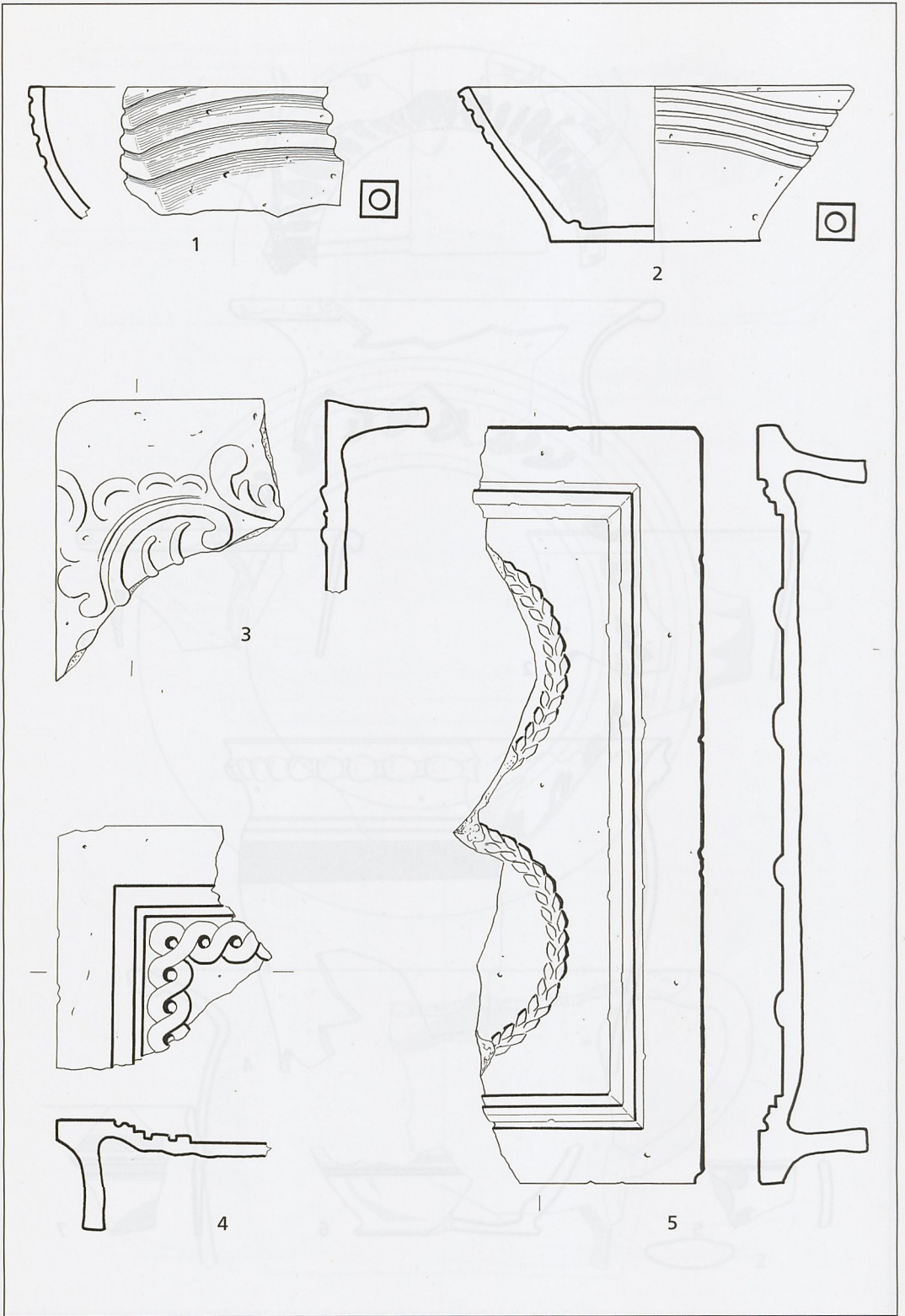

Schwäbisch Hall (Lkr. Schwäbisch Hall). M 1 : 3.

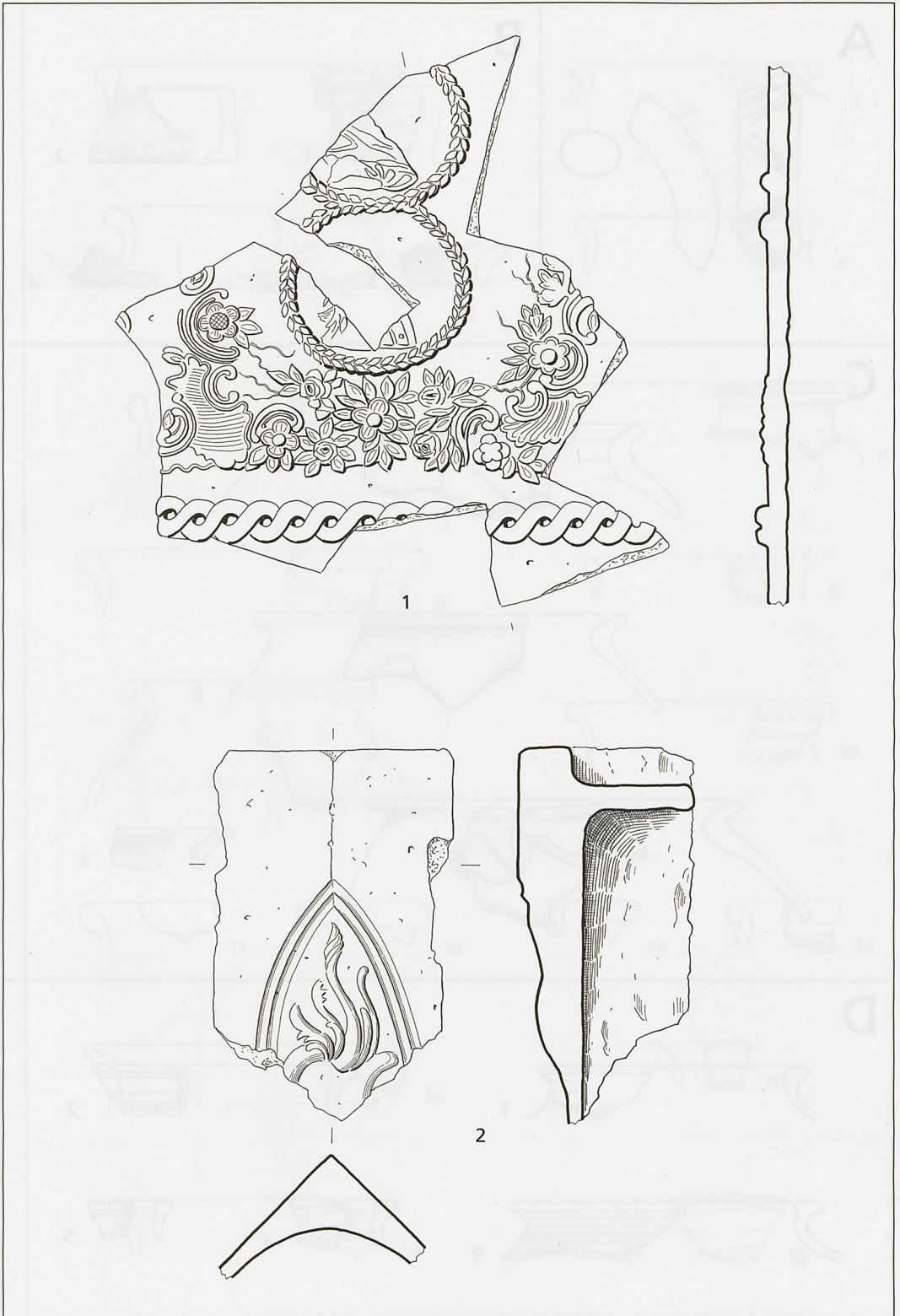

Schwäbisch Hall (Lkr. Schwäbisch Hall). M 1 : 3.

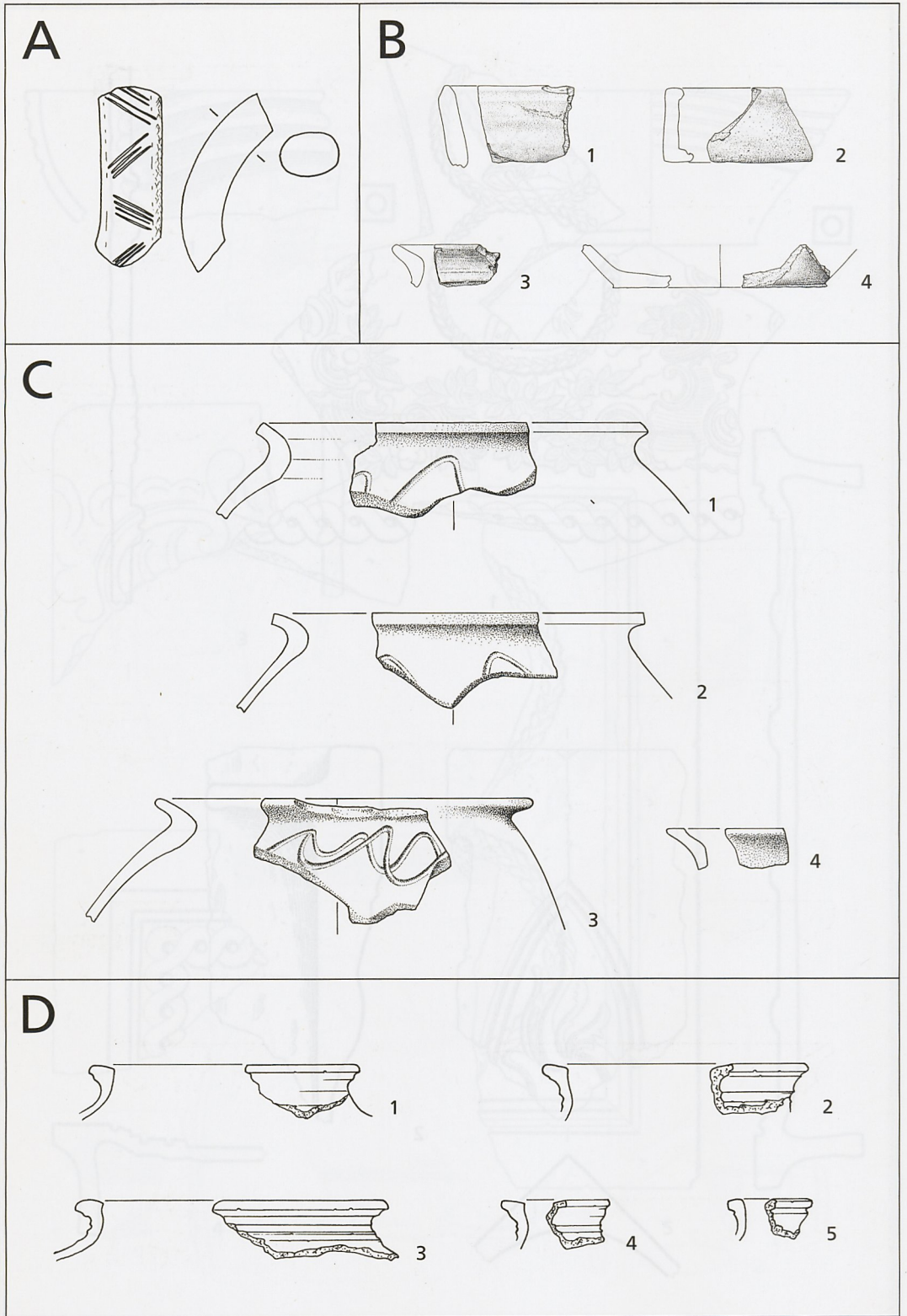

A Seelbach Schönberg (Ortenaukreis). M 1:3. - B Stuttgart Weilimdorf. M 1:3. - C Tuttlingen Möhringen (Lkr. Tuttlingen). M 1:3. - D Ubstadt-Weiher Weiher (Lkr. Karlsruhe). M 1:3.

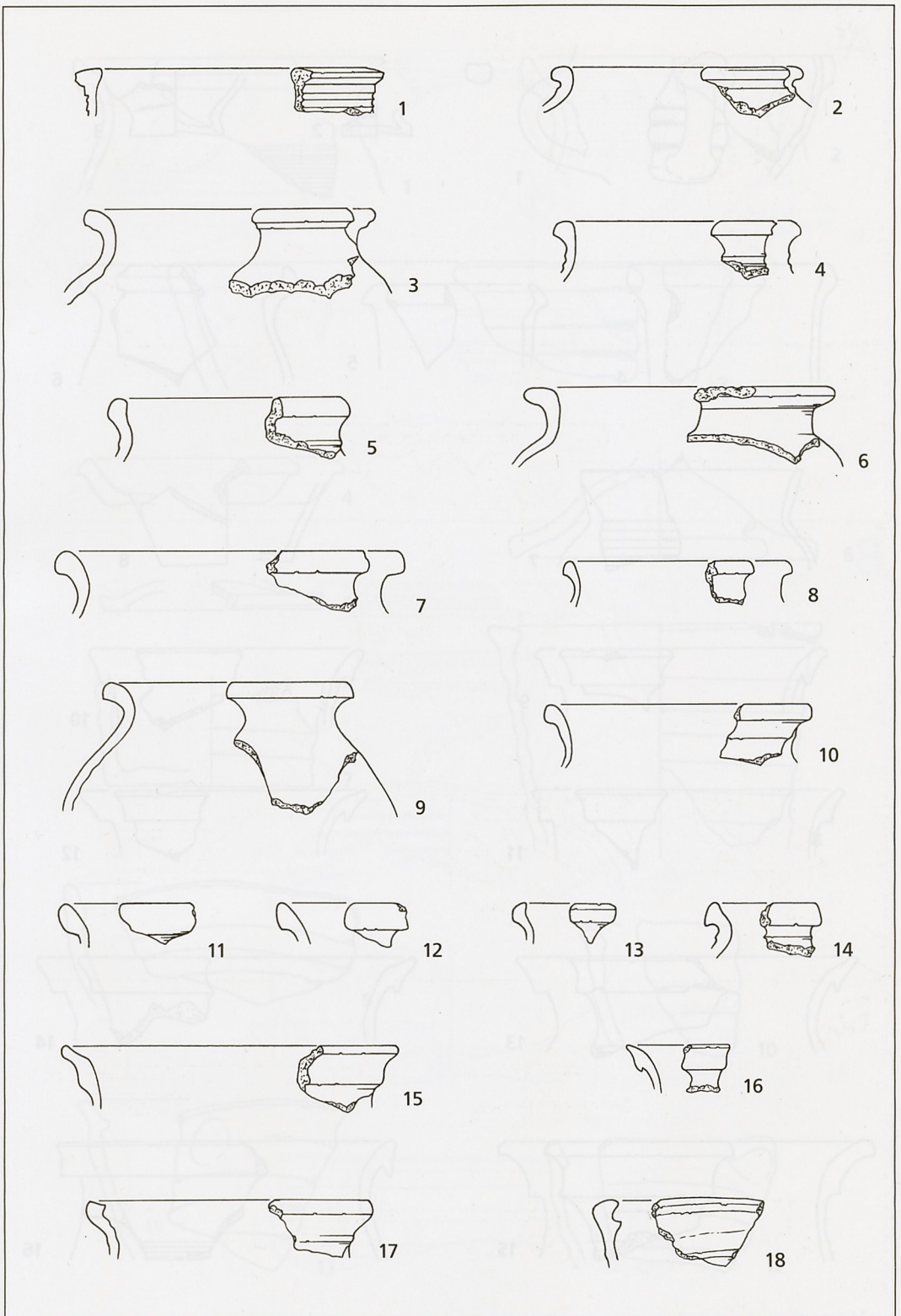

Ubstadt-Weiher Weiher (Lkr. Karlsruhe). M 1 : 3.

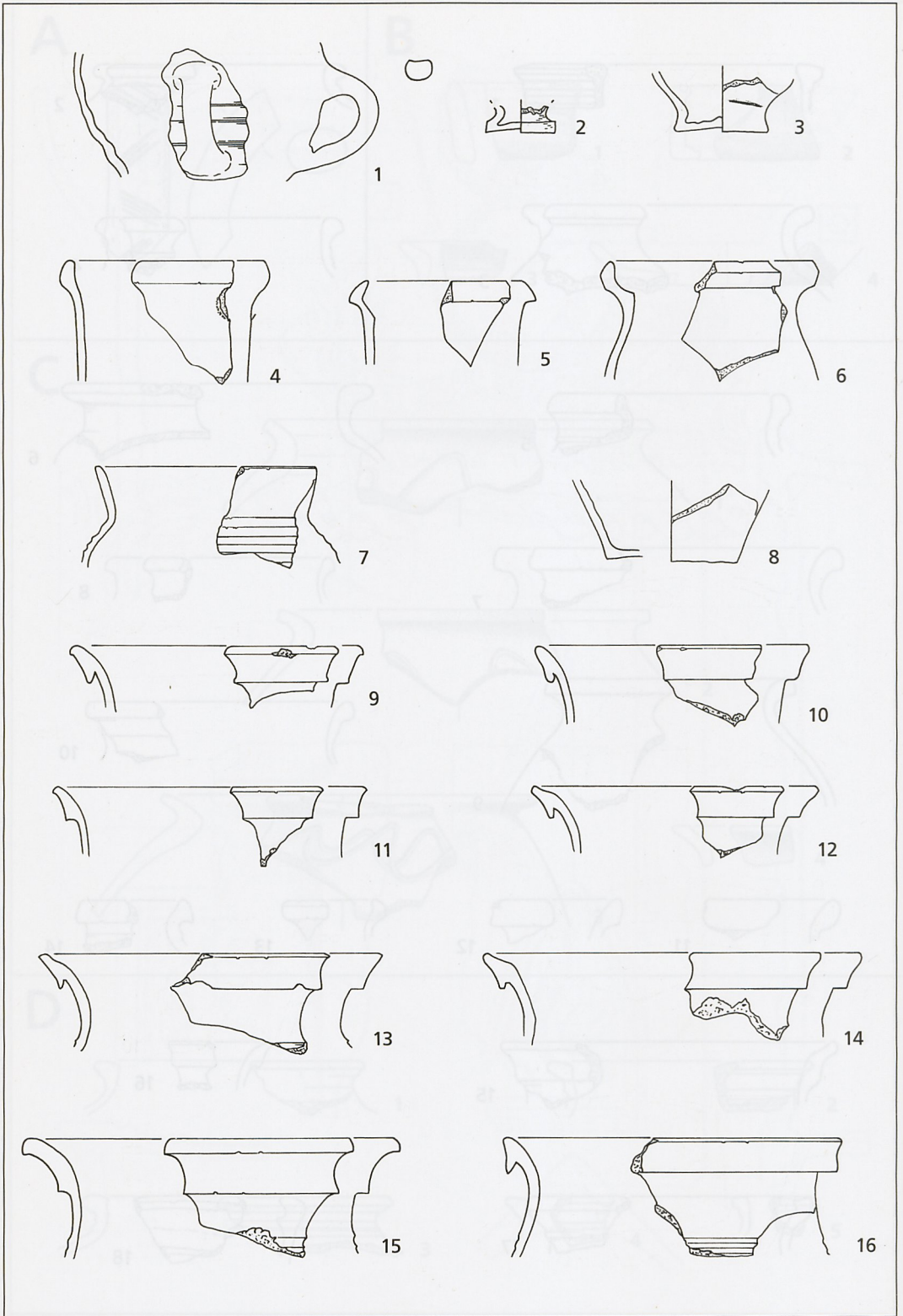

Unterensingen (Lkr. Esslingen). M 1 : 3.

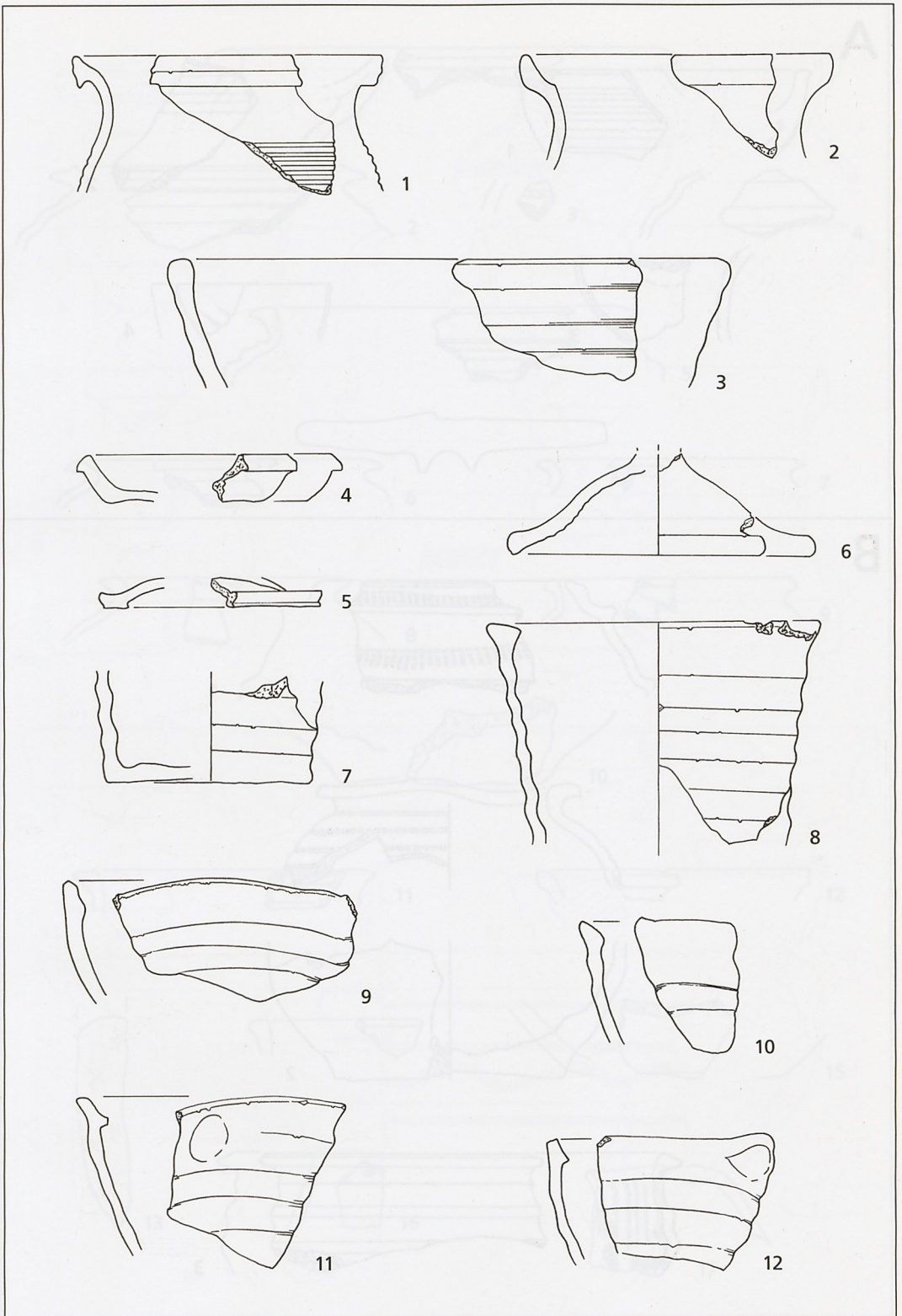

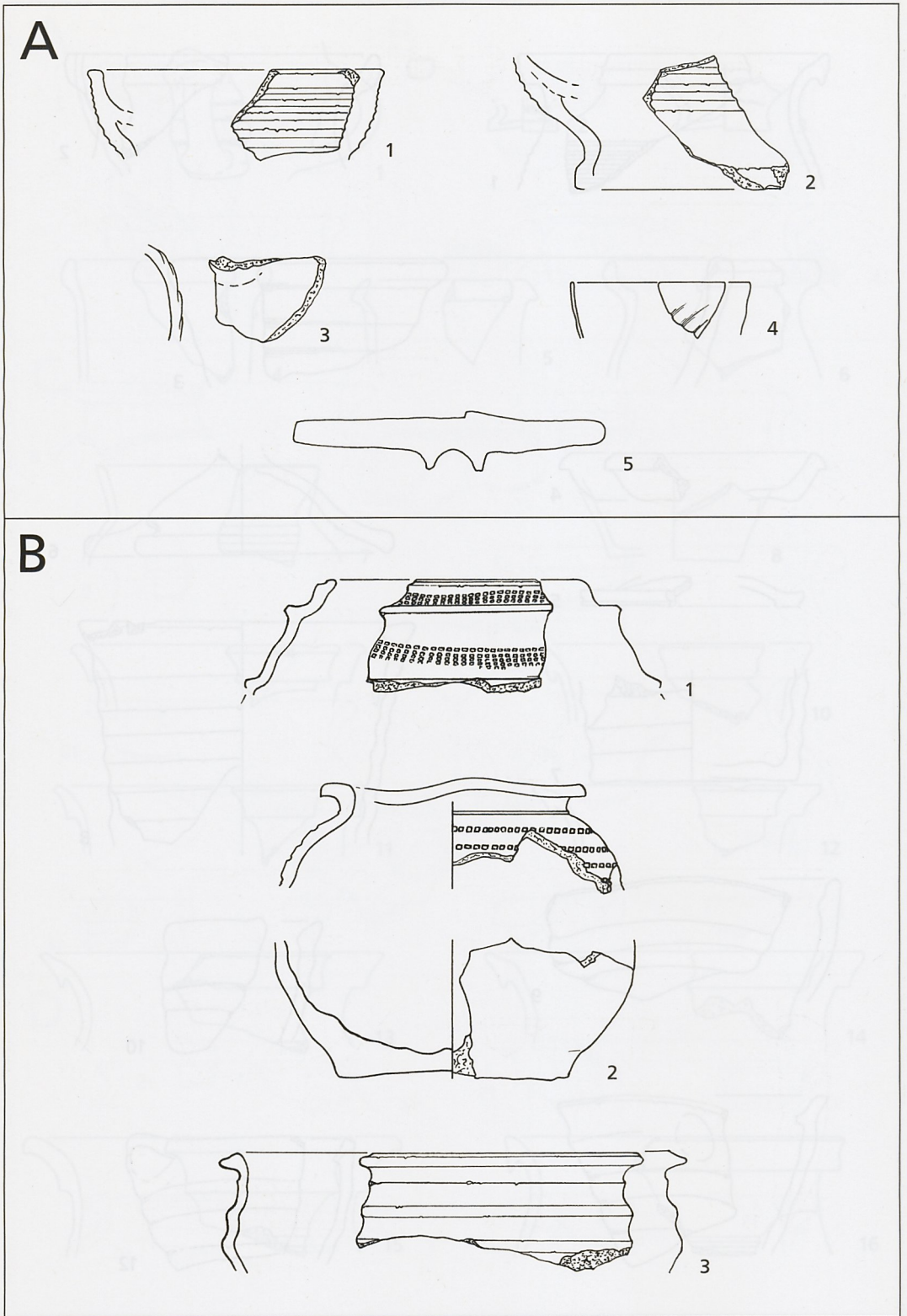

A Unterensingen (Lkr. Esslingen). M 1 : 3. – B Walldorf (Rhein-Neckar-Kreis). Fdst. 1. M 1 : 3.

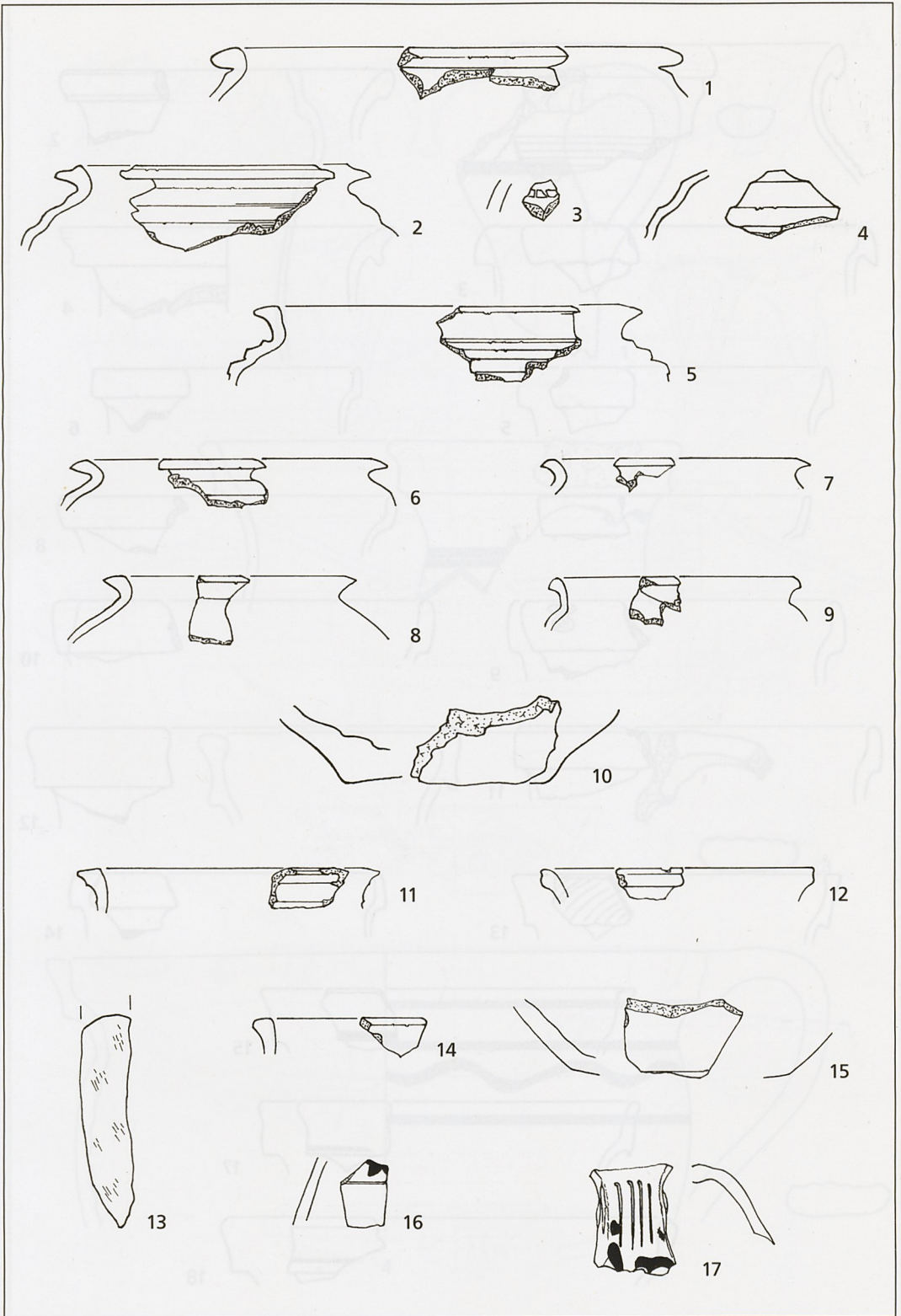

Walldorf (Rhein-Neckar-Kreis). Fdst. 1. M 1 : 3.

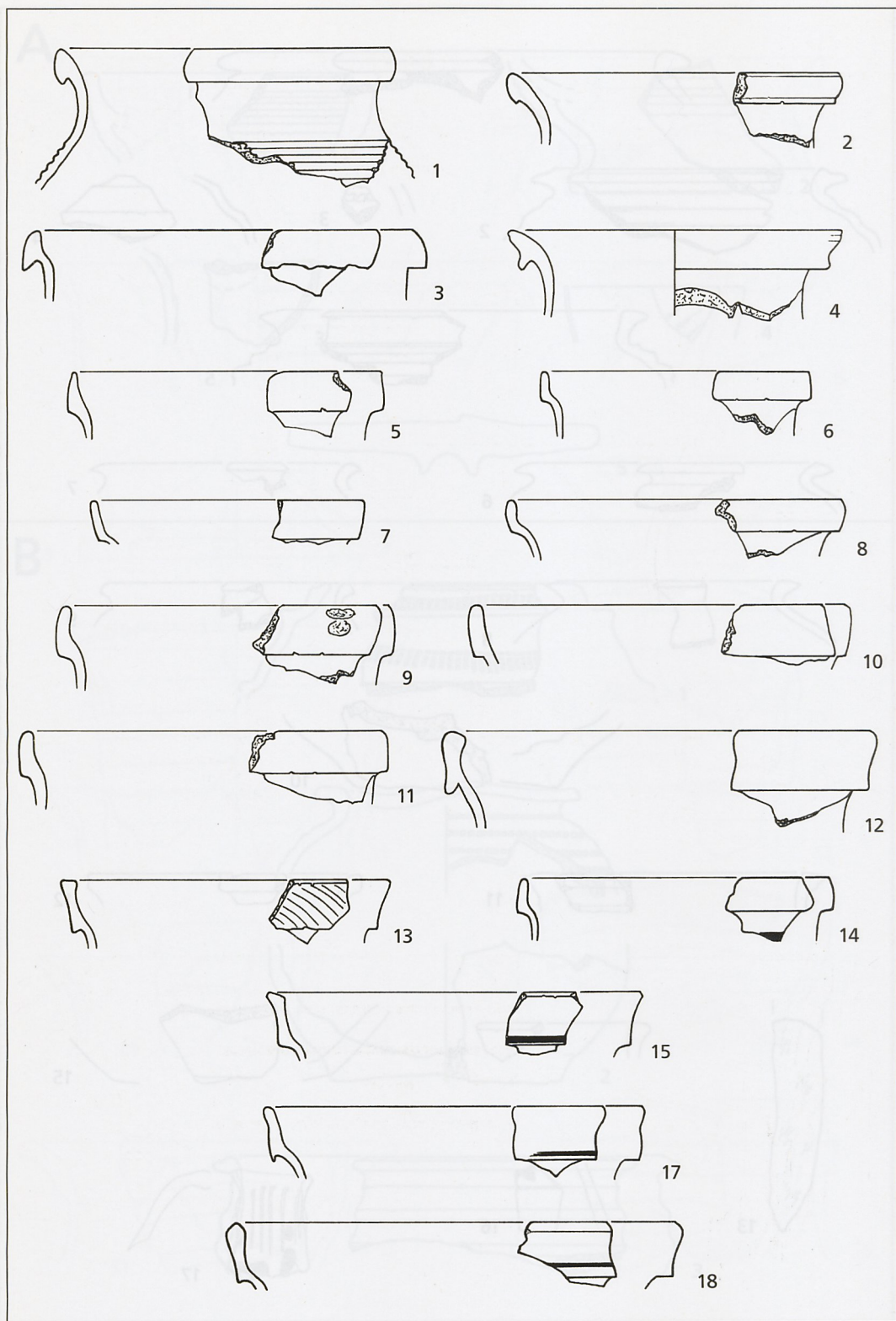

Walldorf (Rhein-Neckar-Kreis). Fdst. 2. M 1 : 3.

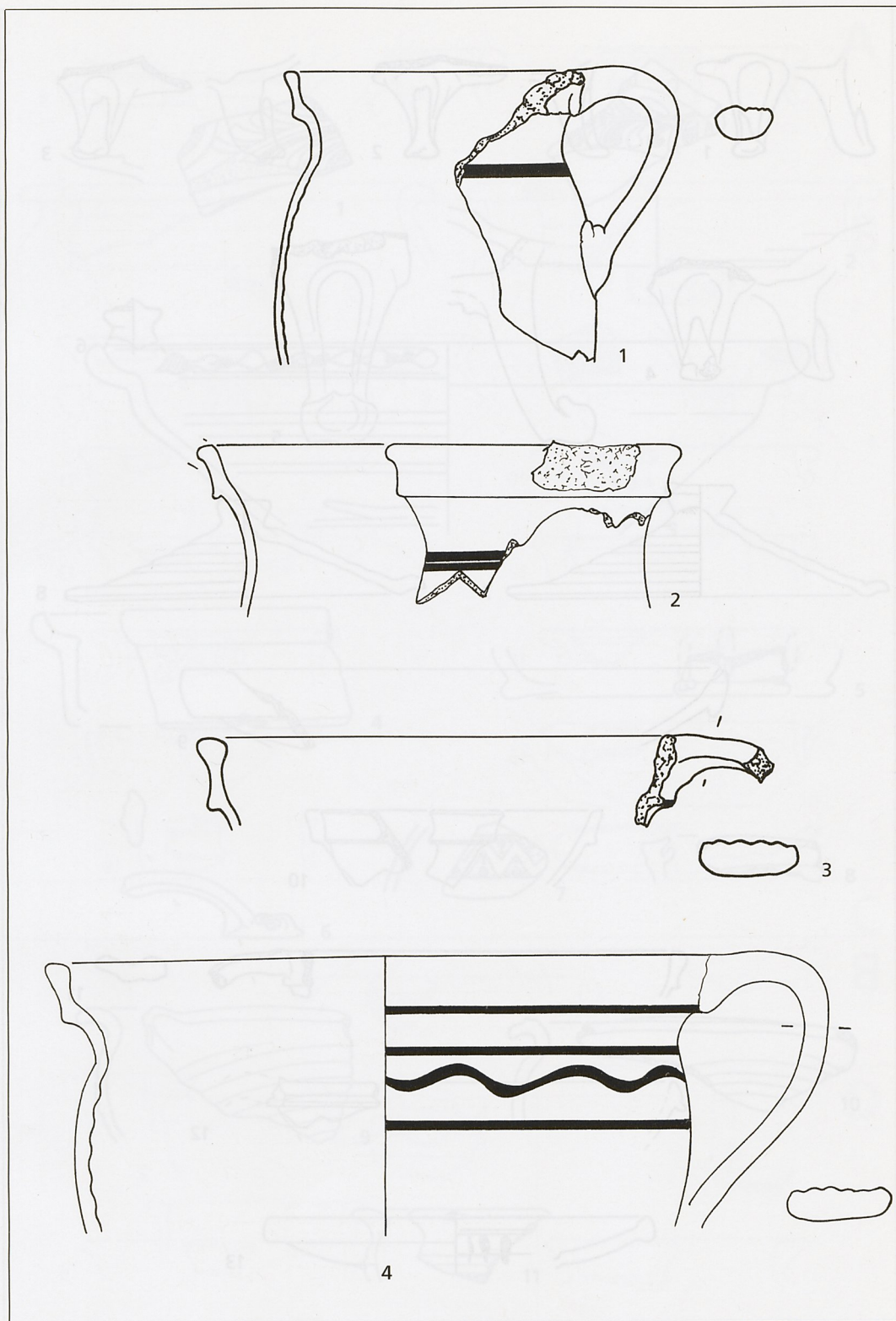

Walldorf (Rhein-Neckar-Kreis). Fdst. 2. M 1 : 3.

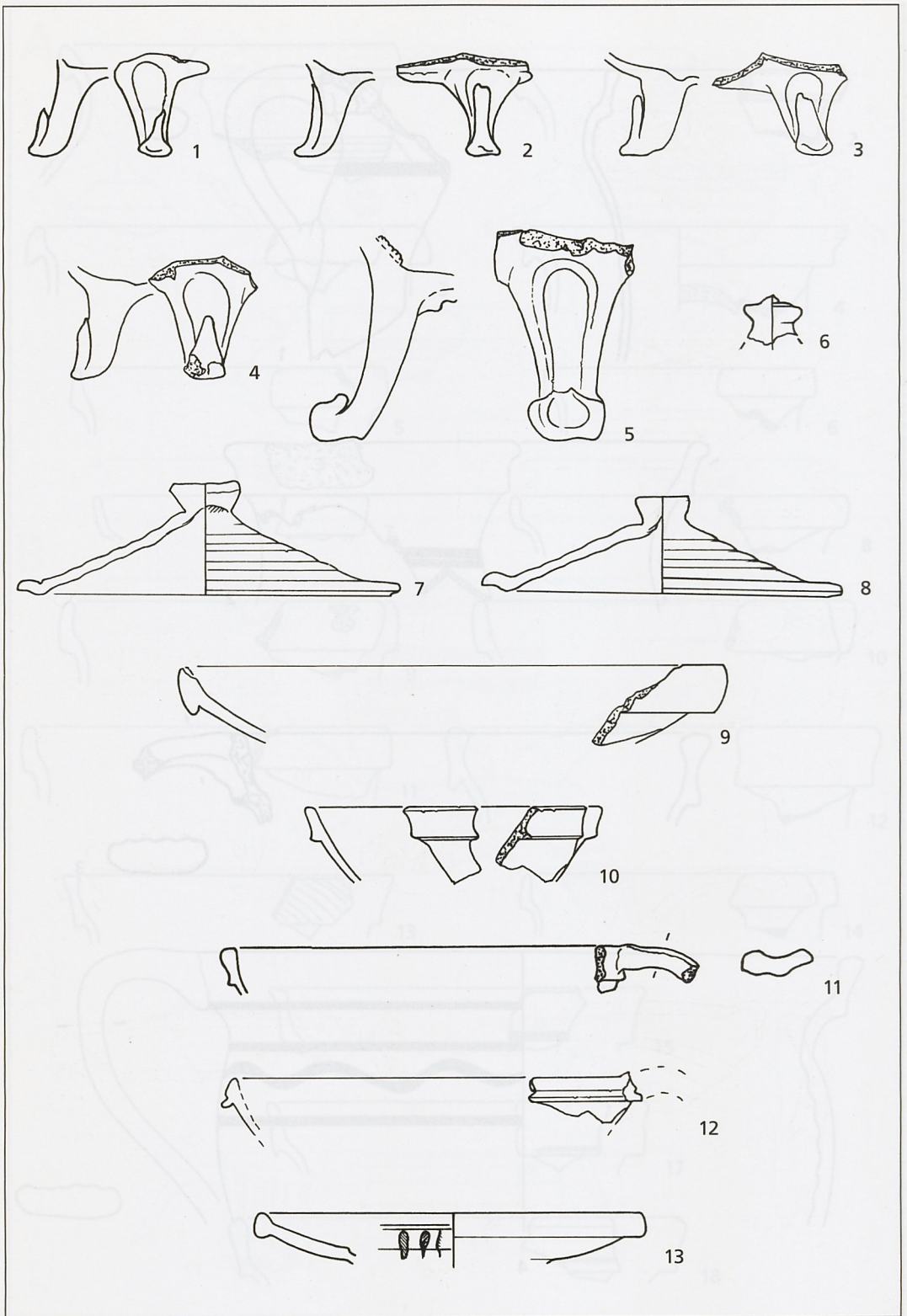

Walldorf (Rhein-Neckar-Kreis). Fdst. 2. M 1 : 3.

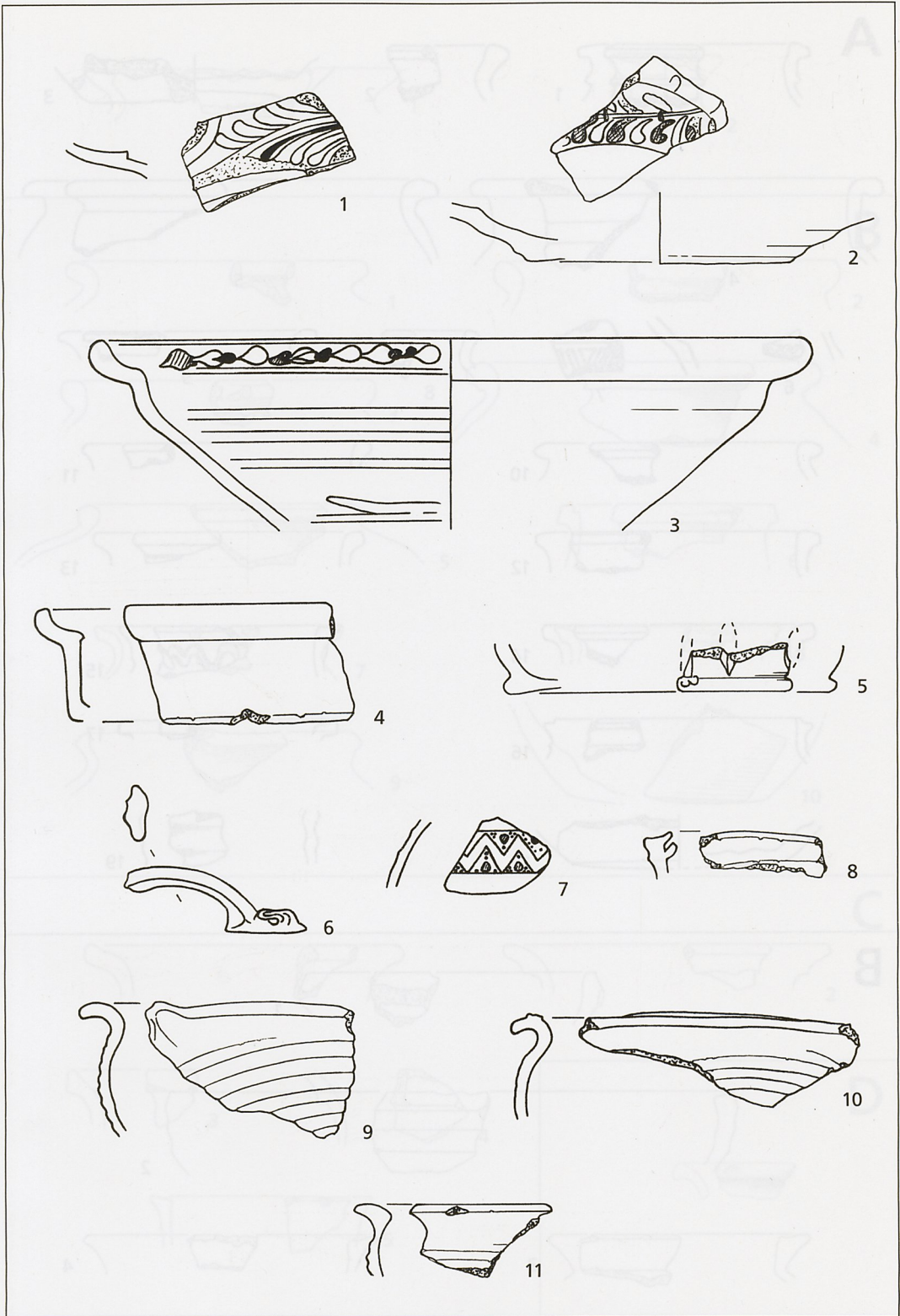

Waldorf (Rhein-Neckar-Kreis). Fdst. 2. M 1 : 3.

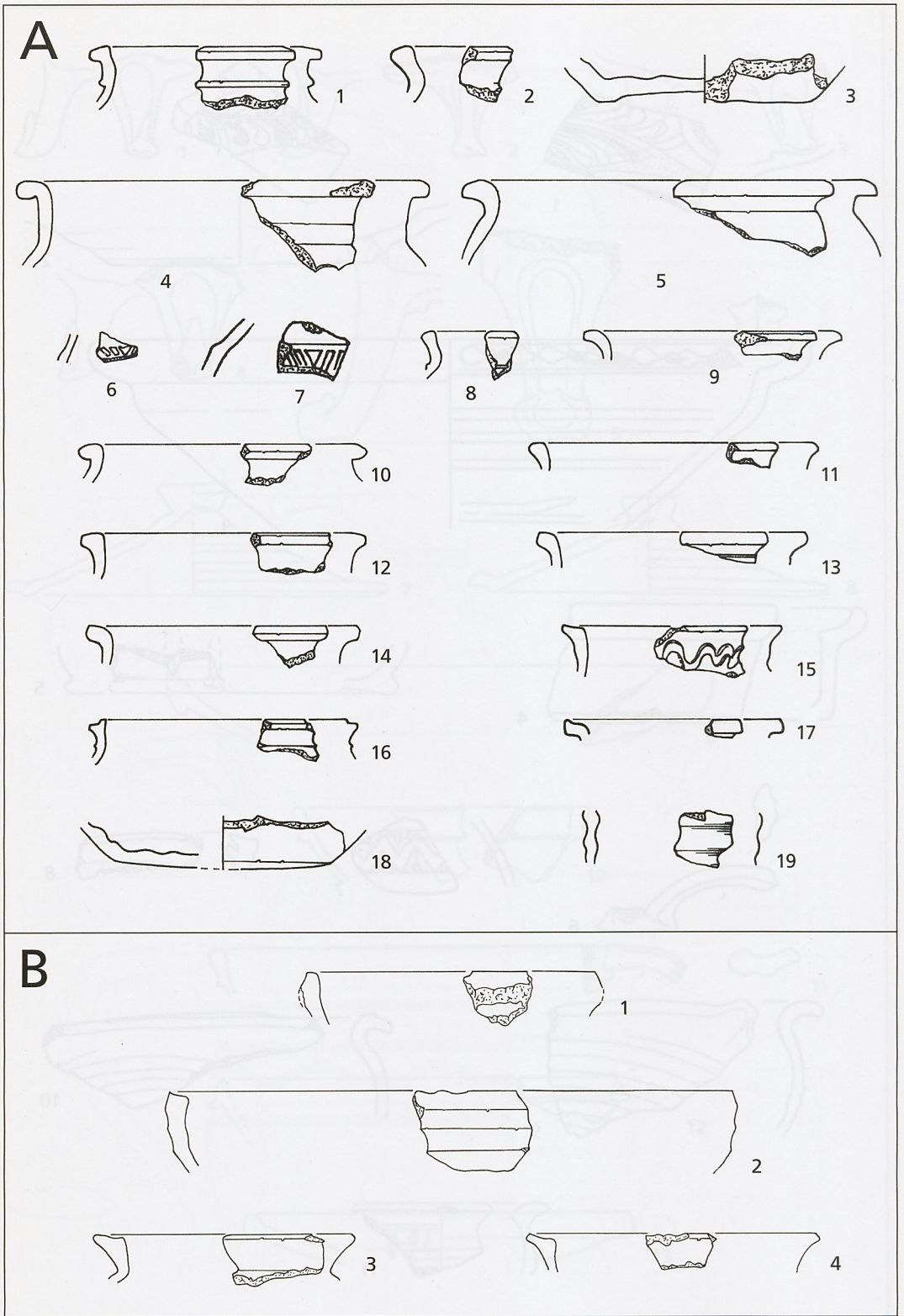

A Walldorf (Rhein-Neckar-Kreis). Fdst. 3. M 1 : 3. – B Weilheim a. d. Teck (Lkr. Esslingen). M 1 : 3.

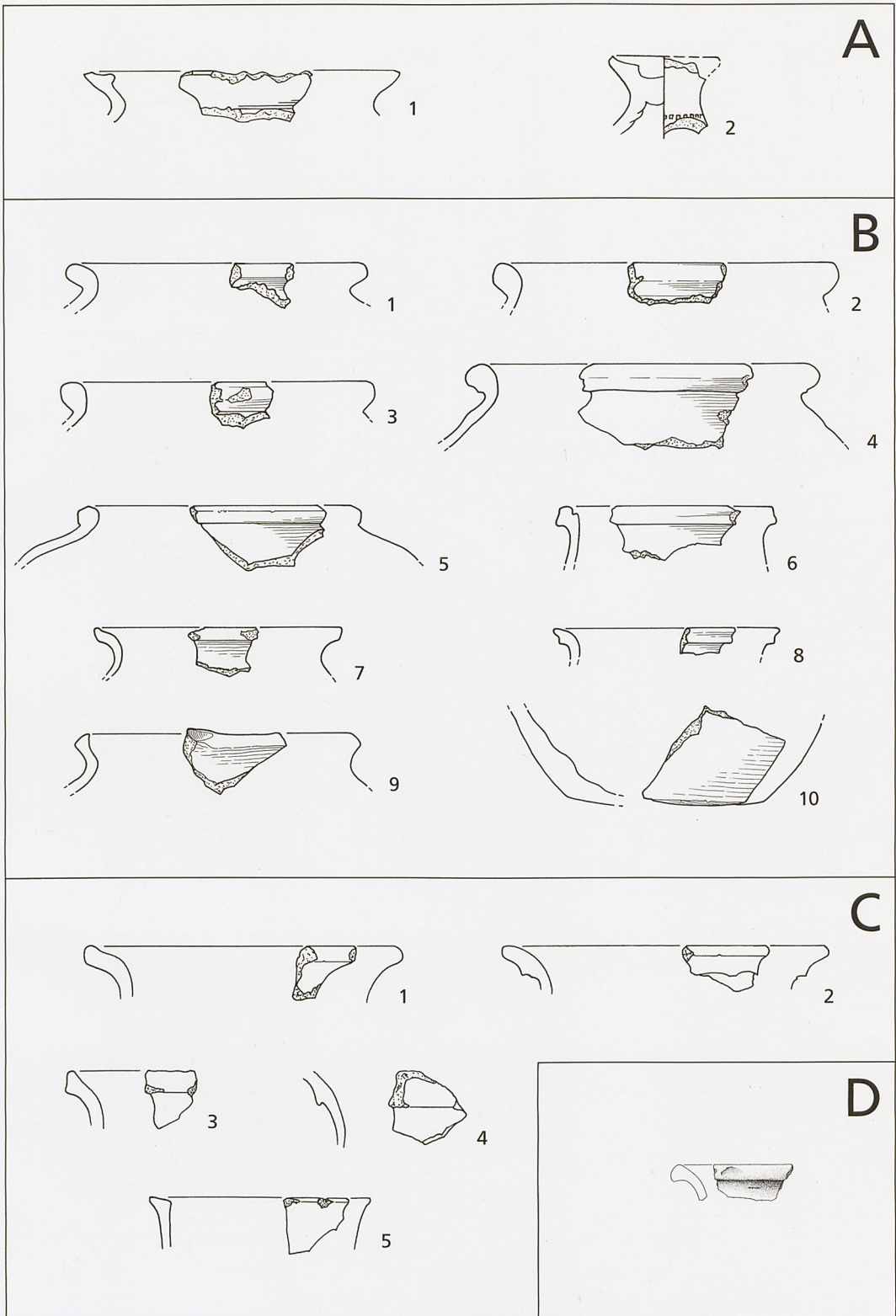

A Weilheim a. d. Teck (Lkr. Esslingen). M 1 : 3. – B Wertheim Reicholzheim (Main-Tauber-Kreis). M 1 : 3. – C Wolfschlugen (Lkr. Esslingen). M 1 : 3. – D Ditzingen (Lkr. Ludwigsburg). M 1 : 3.