

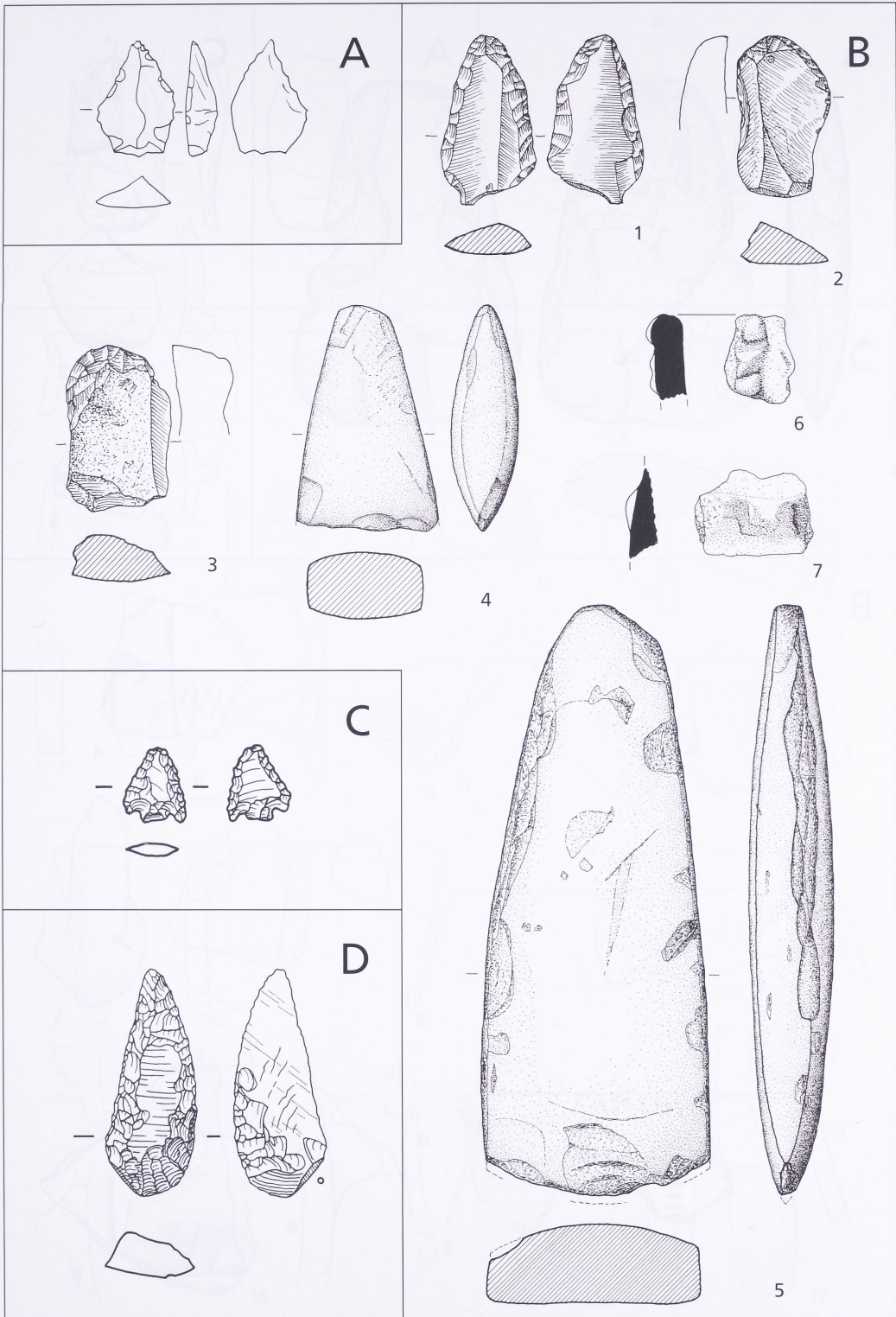

Tafeln 1-46

A Badenweiler, St. Ursulahof (Alt. Badens Hochdörferswald), M 2-3. - B Elmog, Mittel
 Bismstegen (Alt. Lössen), 1-3 M 2, 3-4 M 1, 2. - C Elmog, Kirchen, Hottling, 1-2 (Alt.
 Lössen), Ftbl. 1, M 2/3. - D Elmog, Kirchen, Hottling, 1-2 (Alt. Lössen), Ftbl. 2, M 2/3.



A Badenweiler Schweighof (Lkr. Breisgau-Hochschwarzwald). M 2:3. – B Efringen-Kirchen Blansingen (Lkr. Lörrach). 1–3 M 2:3; 4–7 M 1:2. – C Efringen-Kirchen Huttingen (Lkr. Lörrach). Fdst. 1. M 2:3. – D Efringen-Kirchen Huttingen (Lkr. Lörrach). Fdst. 2. M 2:3.

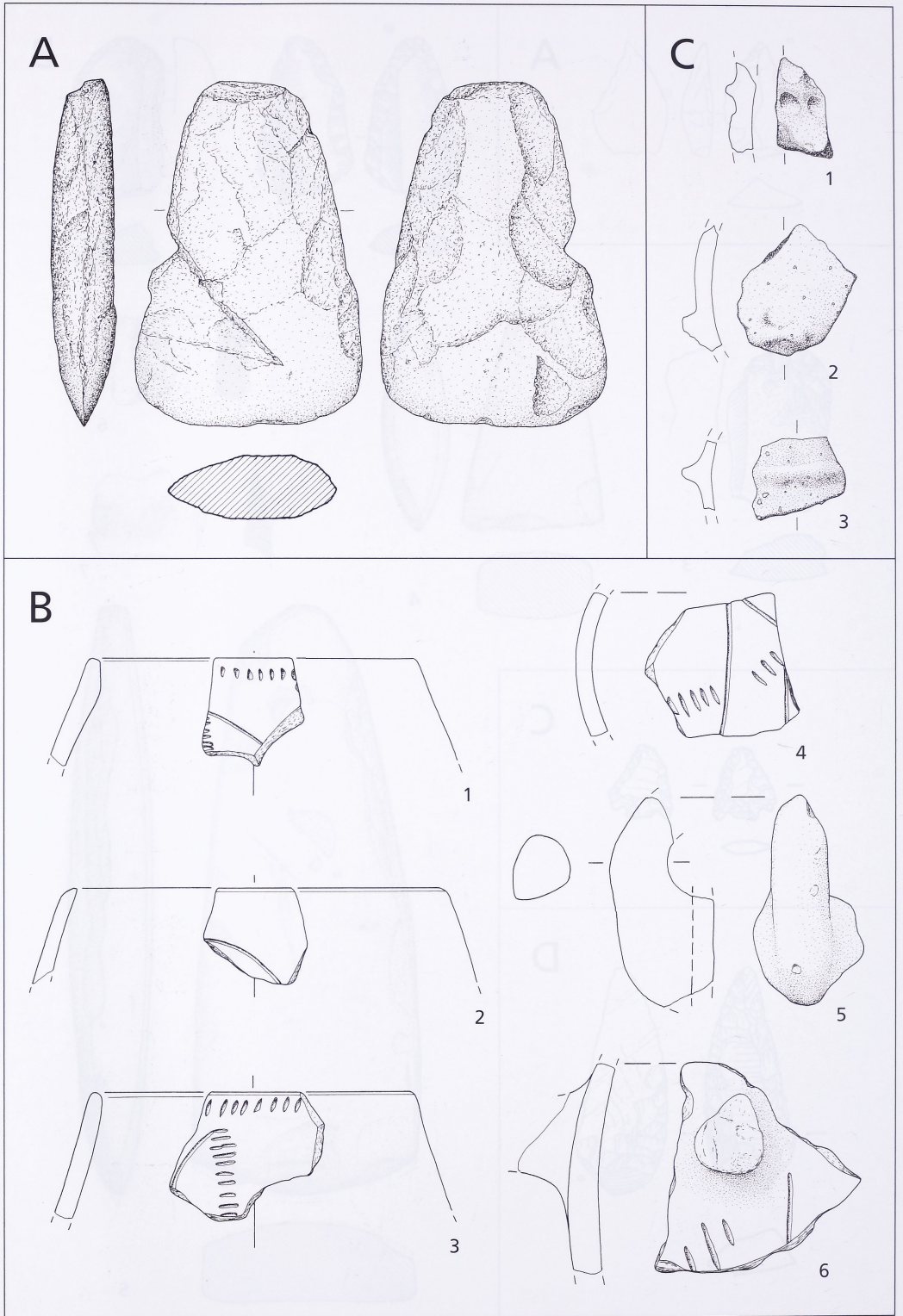

A Efringen-Kirchen B l a n s i n g e n (Lkr. Lörrach). M 1:2. - B Fellbach (Rems-Murr-Kreis).
M 1:2. - C Forchheim (Lkr. Emmendingen). Fdst. 2. M 1:3.

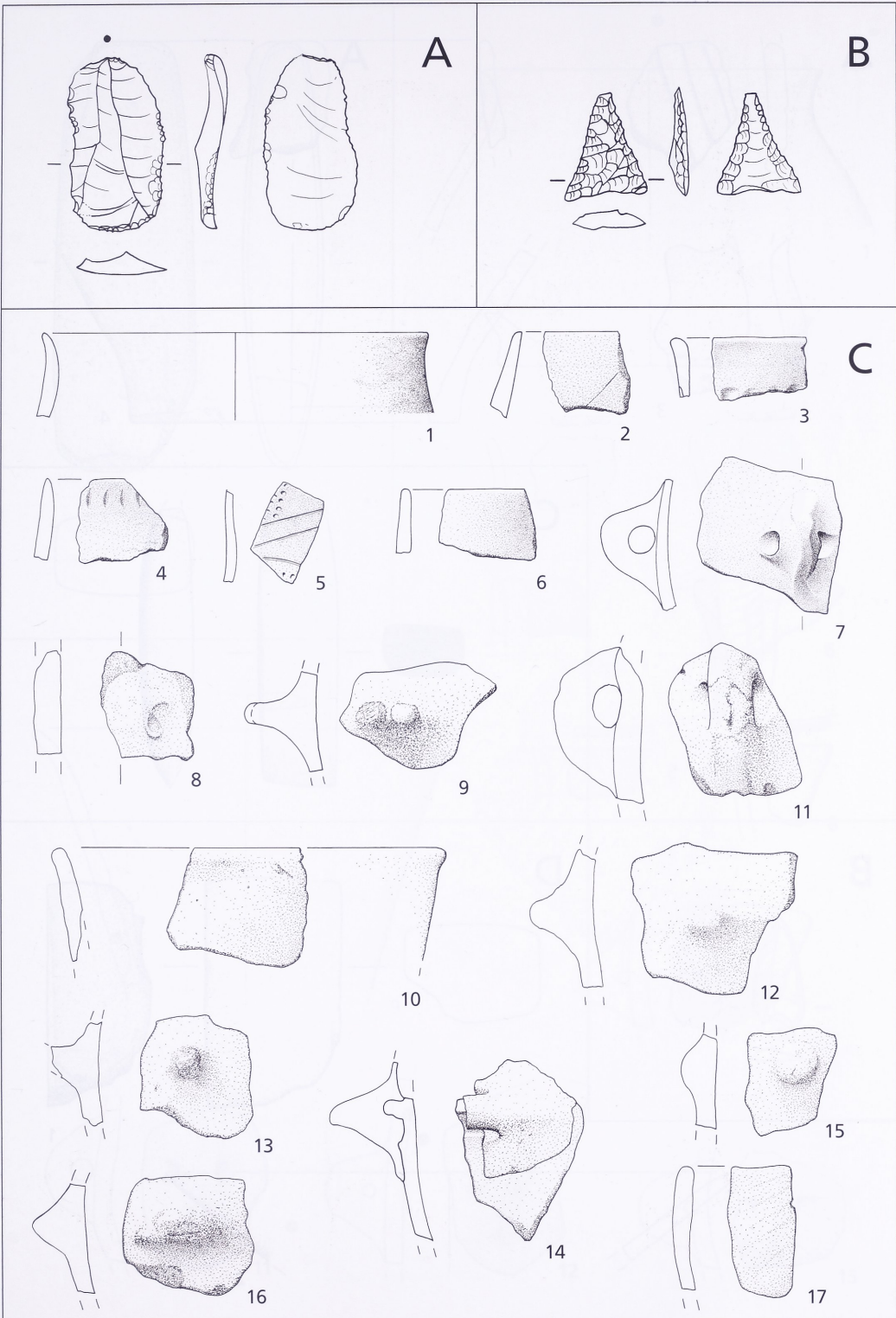

A Forchheim (Lkr. Emmendingen). Fdst. 1. M 2:3. – B Forchheim (Lkr. Emmendingen). Fdst. 2. M 2:3. – C Freiburg im Breisgau O p f i n g e n. M 1:3.

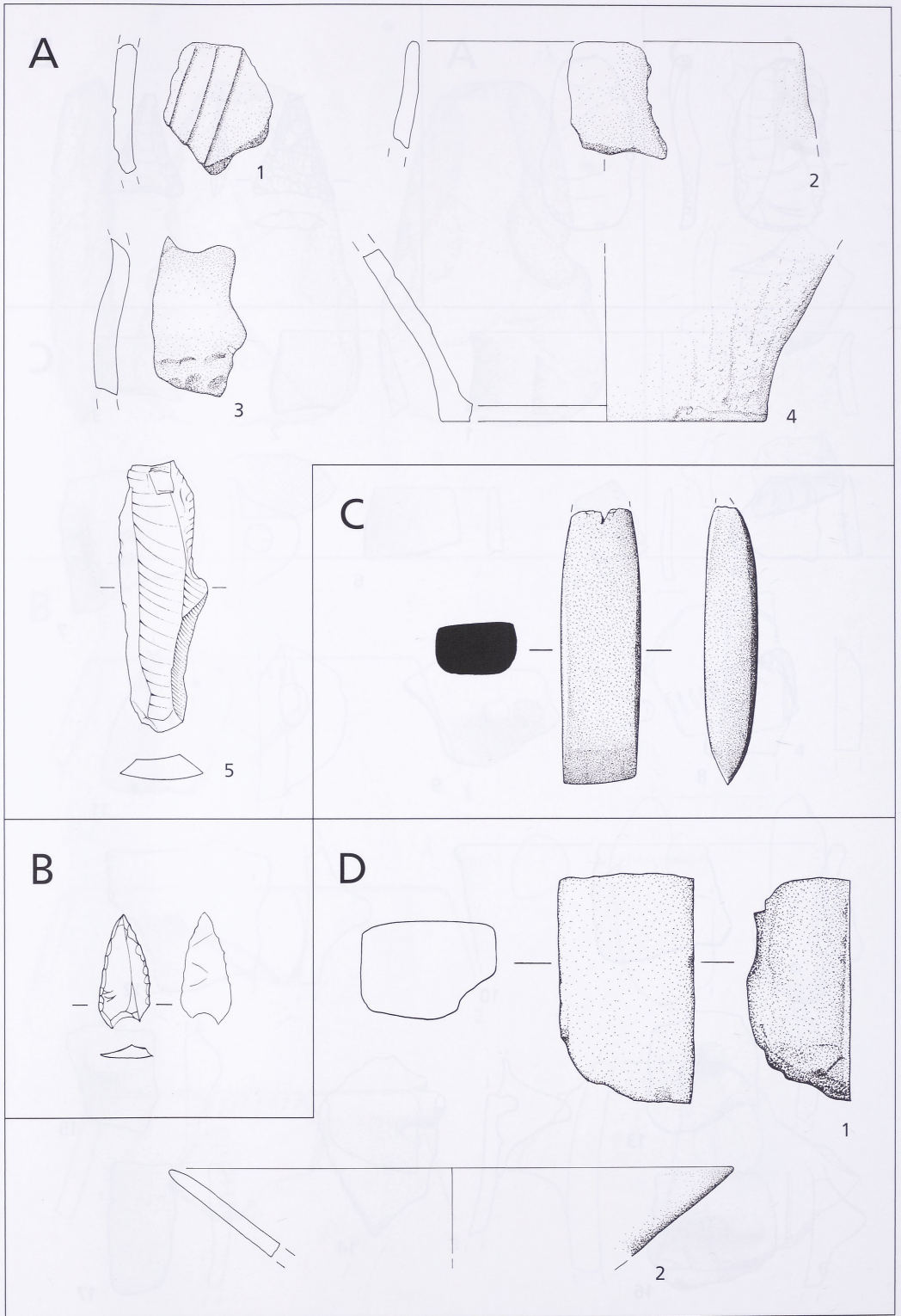

A Freiburg im Breisgau Opfingen. 1-4 M 1:3; 5 M 2:3. - B Kirchzarten Zarten (Lkr. Breisgau-Hochschwarzwald). M 2:3. - C Müllheim (Lkr. Breisgau-Hochschwarzwald). M 1:2. - D Riegel (Lkr. Emmendingen). Fdst. 1. 1 M 1:2; 2 M 1:3.

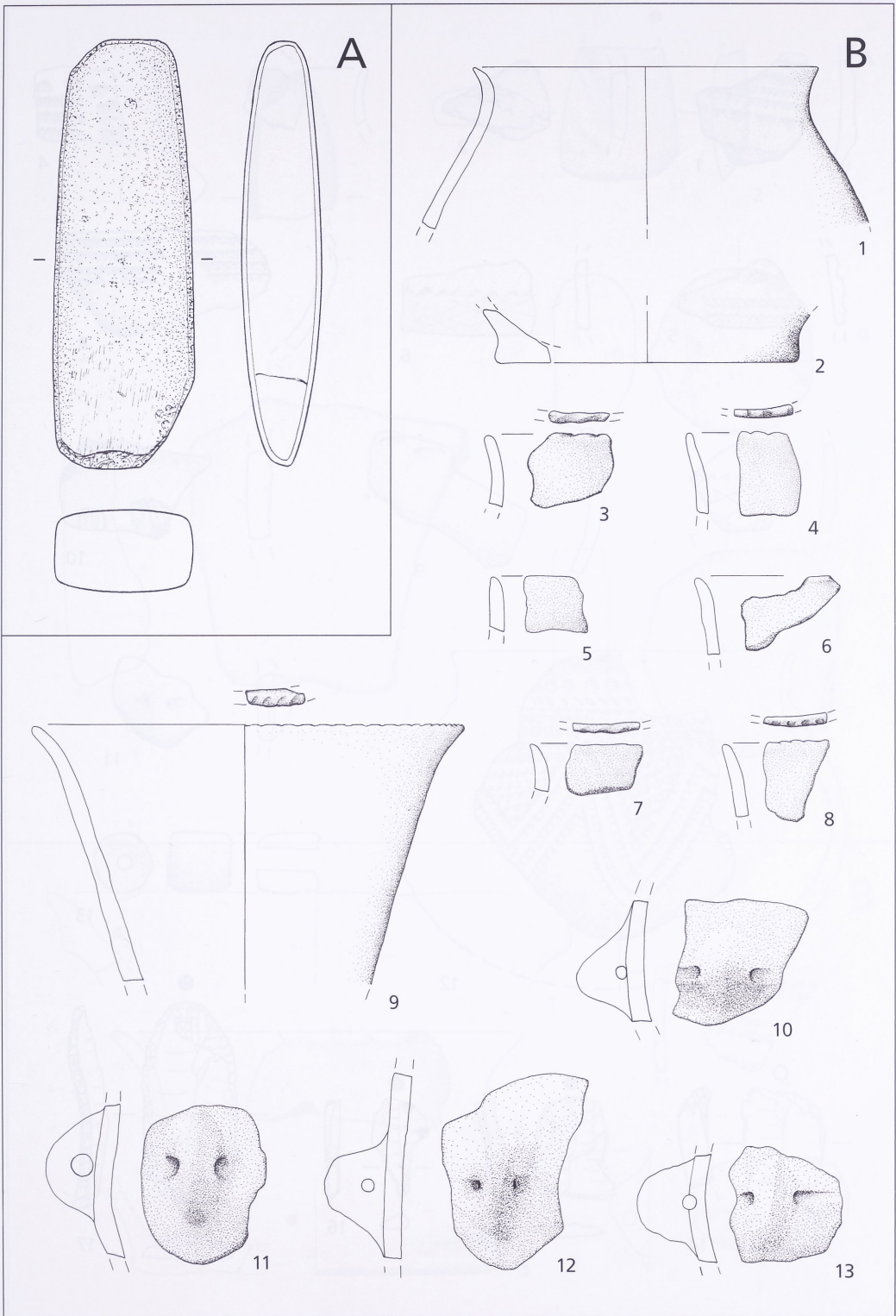

A Öhningen W a n g e n (Lkr. Konstanz). M 1:2. – B Riegel (Lkr. Emmendingen). Fdst. 1.
M 1:3.

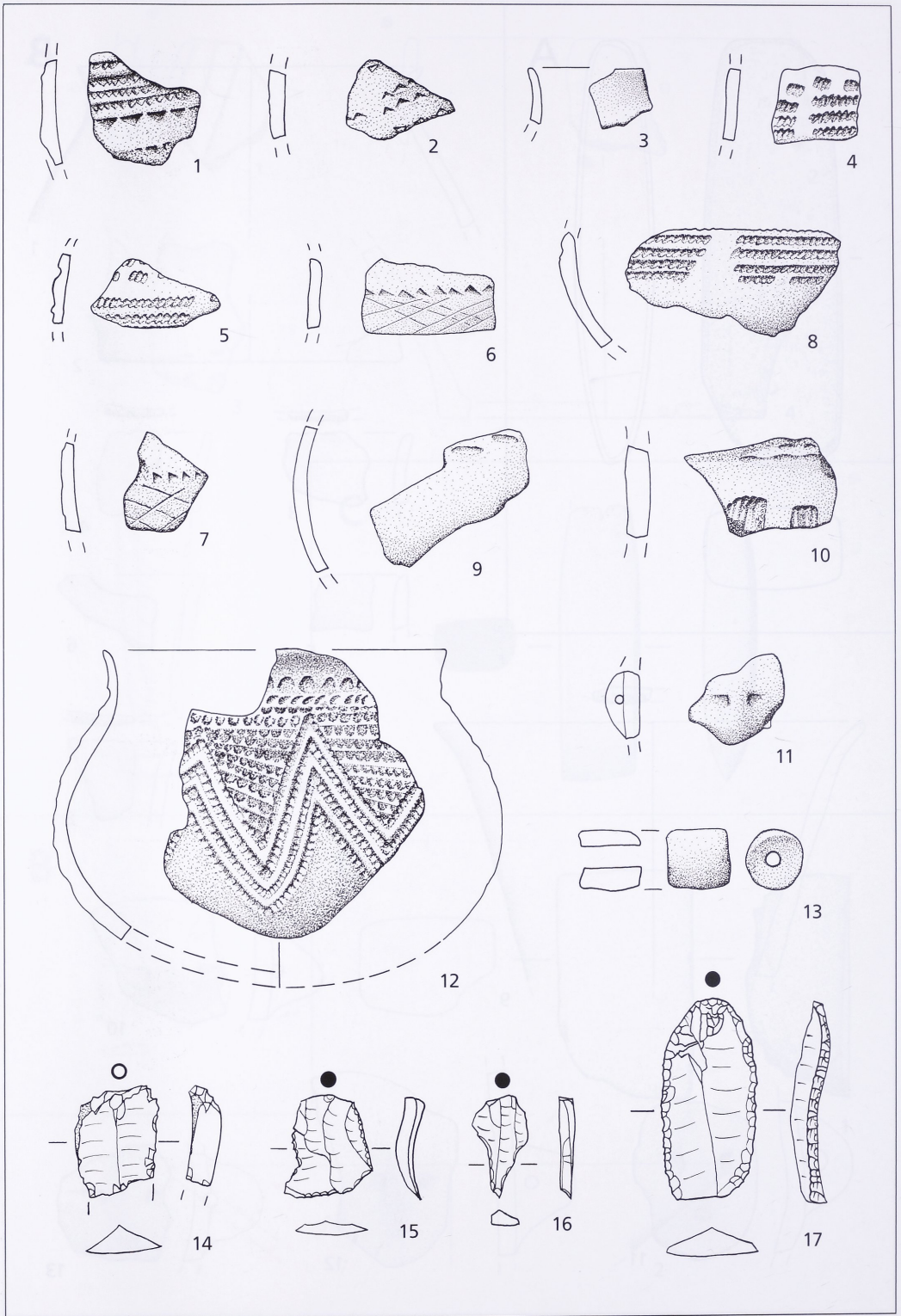

Riegel (Lkr. Emmendingen). Fdst. 1. 1-13 M 1:2; 14-17 M 2:3.

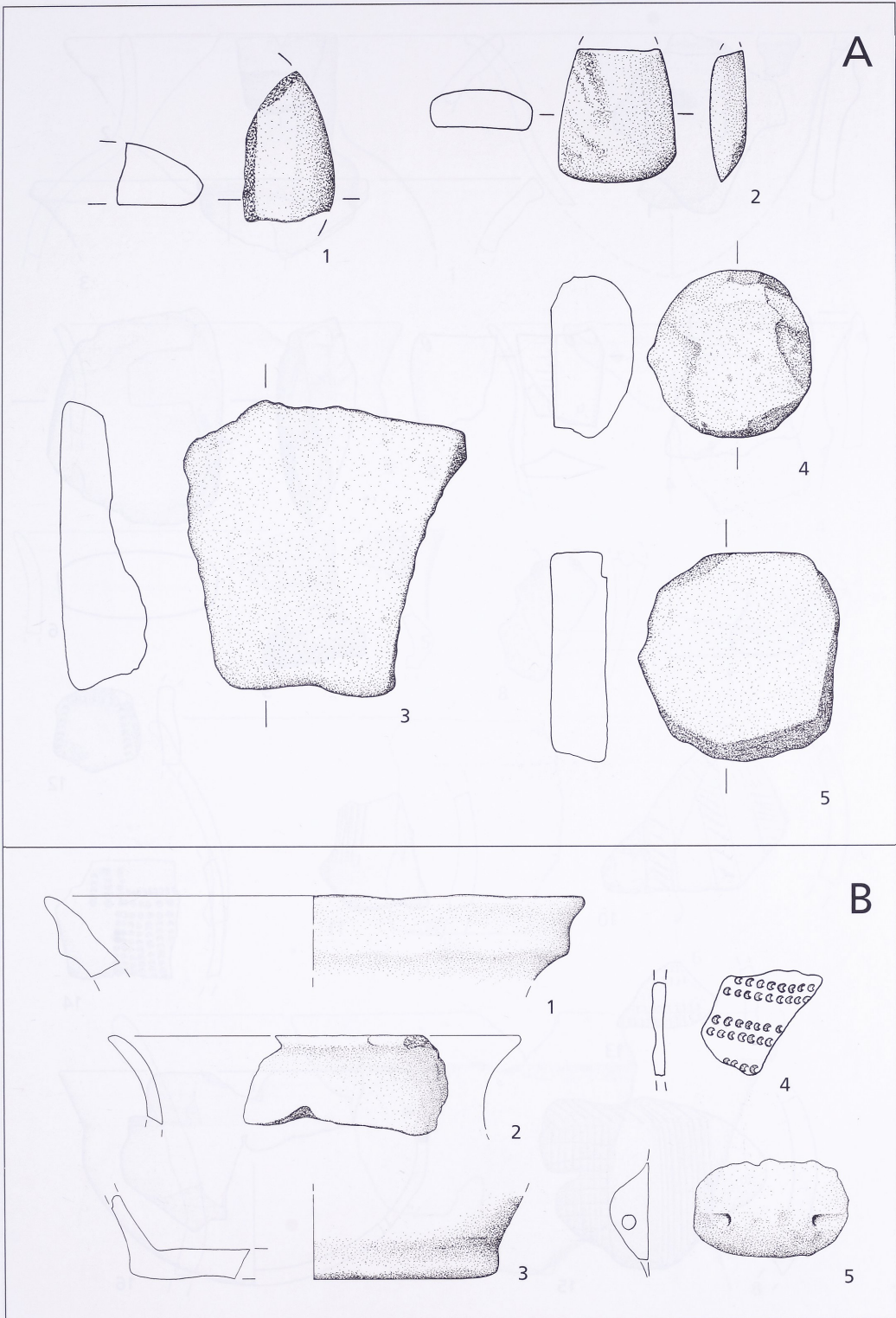

A Riegel (Lkr. Emmendingen). Fdst. 1. 1 u. 2 M 1:2; 3-5 M 1:3. – B Riegel (Lkr. Emmendingen).
Fdst. 2. 1-3 u. 5 M 1:3; 4 M 1:2.

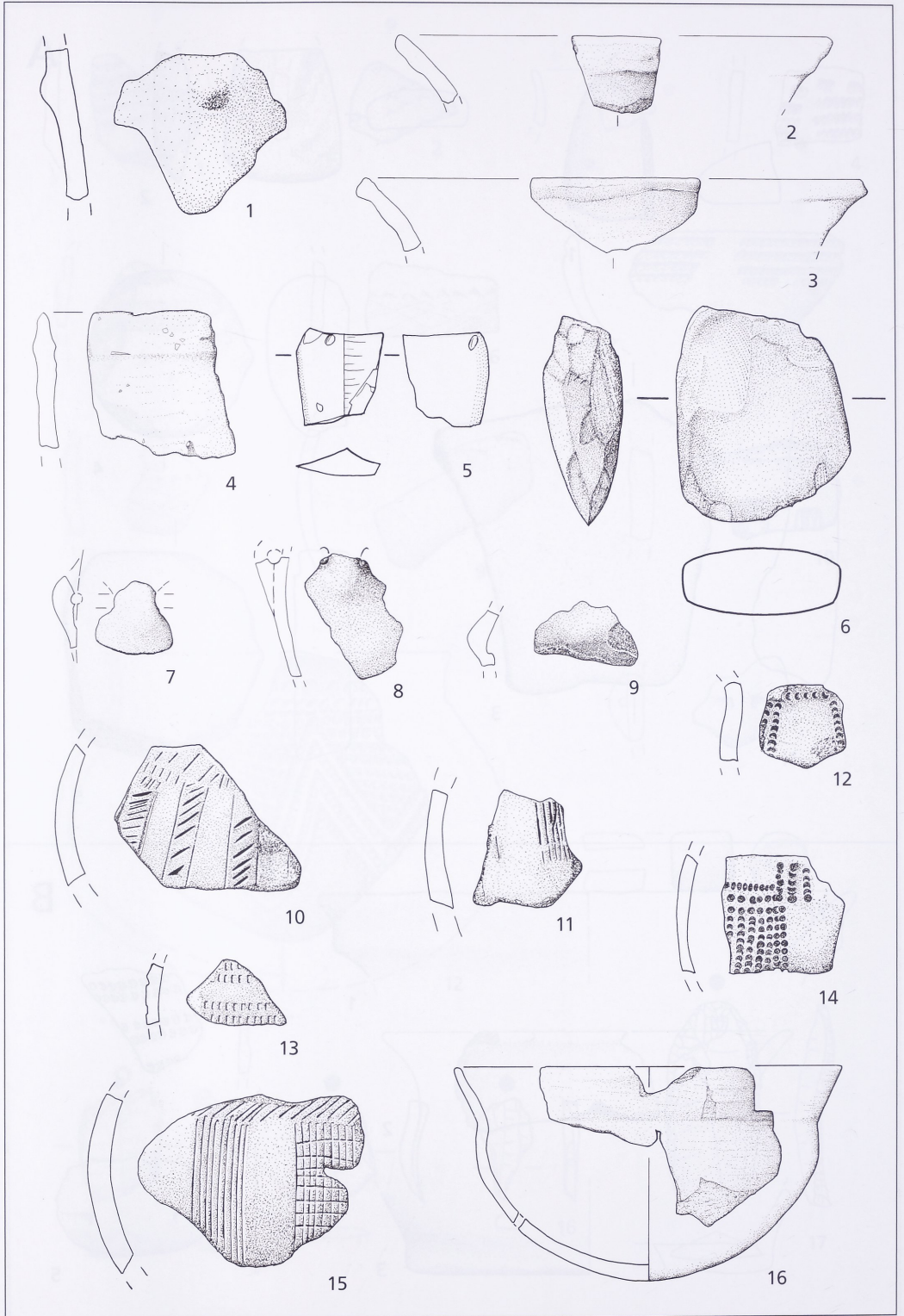

Riegel (Lkr. Emmendingen). Fdst. 2. 1-4-7-9 u. 16 M 1:3; 5 M 2:3; 6.10-15 M 1:2.

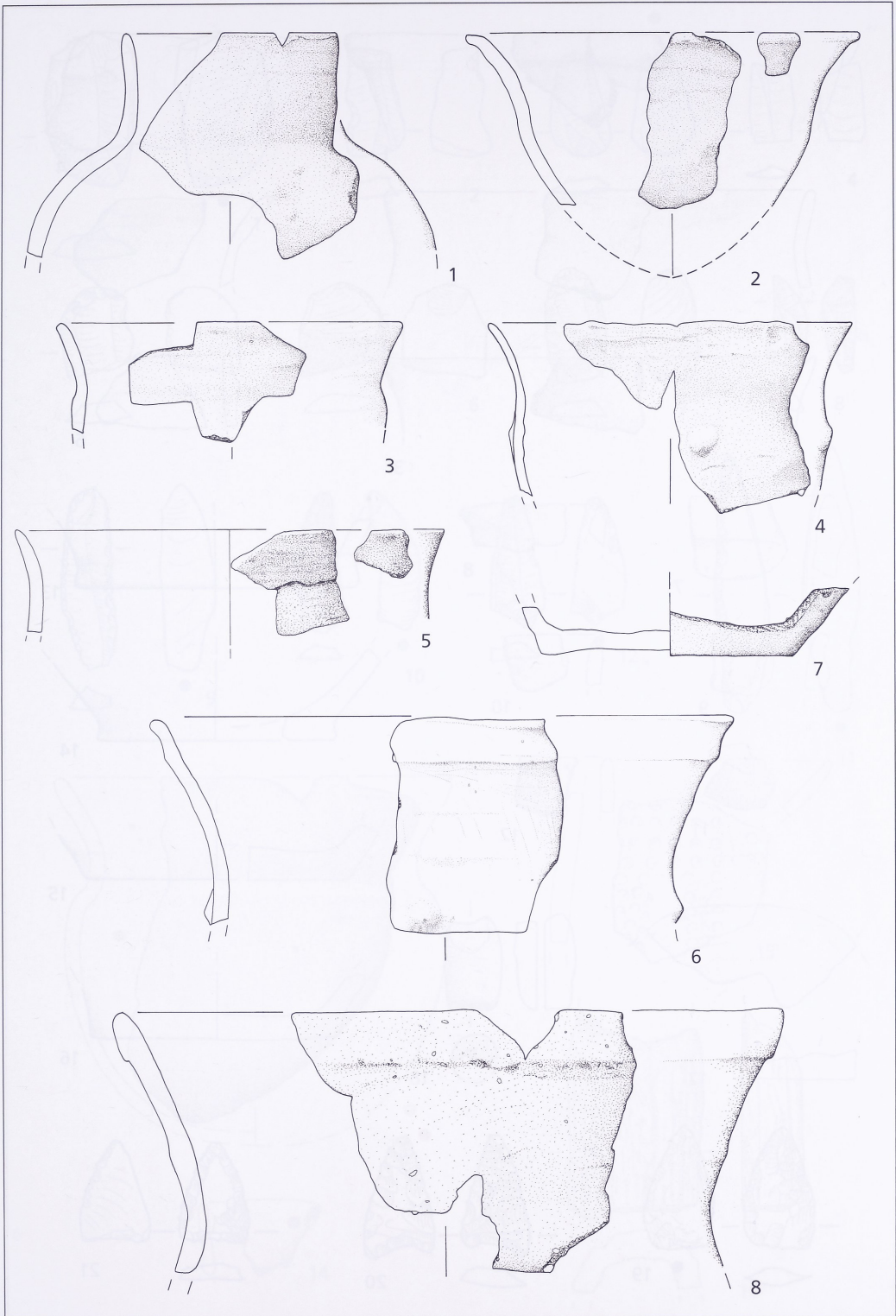

Riegel (Lkr. Emmendingen). Fdst. 2. M 1:3.

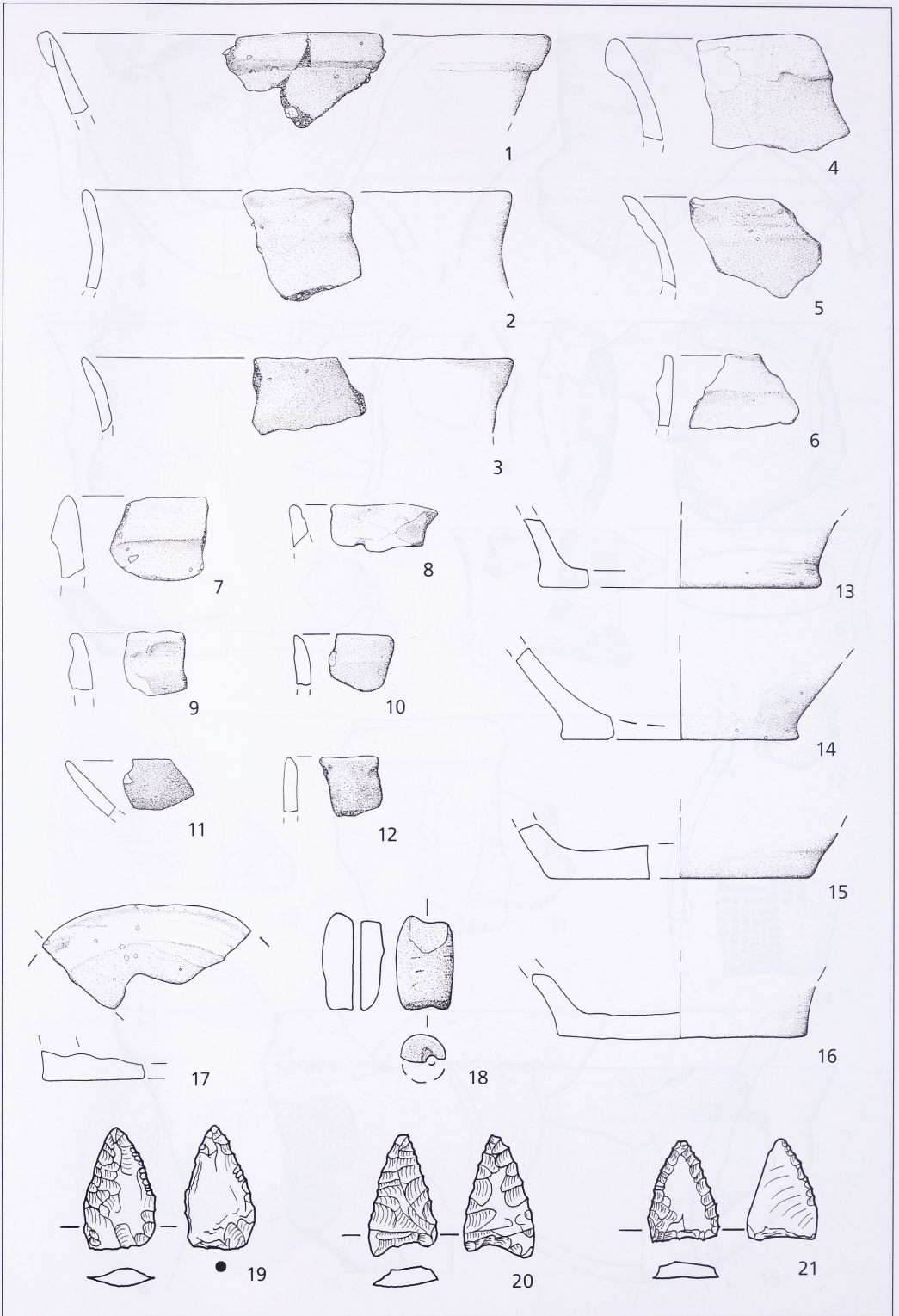

Riegel (Lkr. Emmendingen). Fdst. 2. 1-17 M 1:3; 18 M 1:2; 19-21 M 2:3.

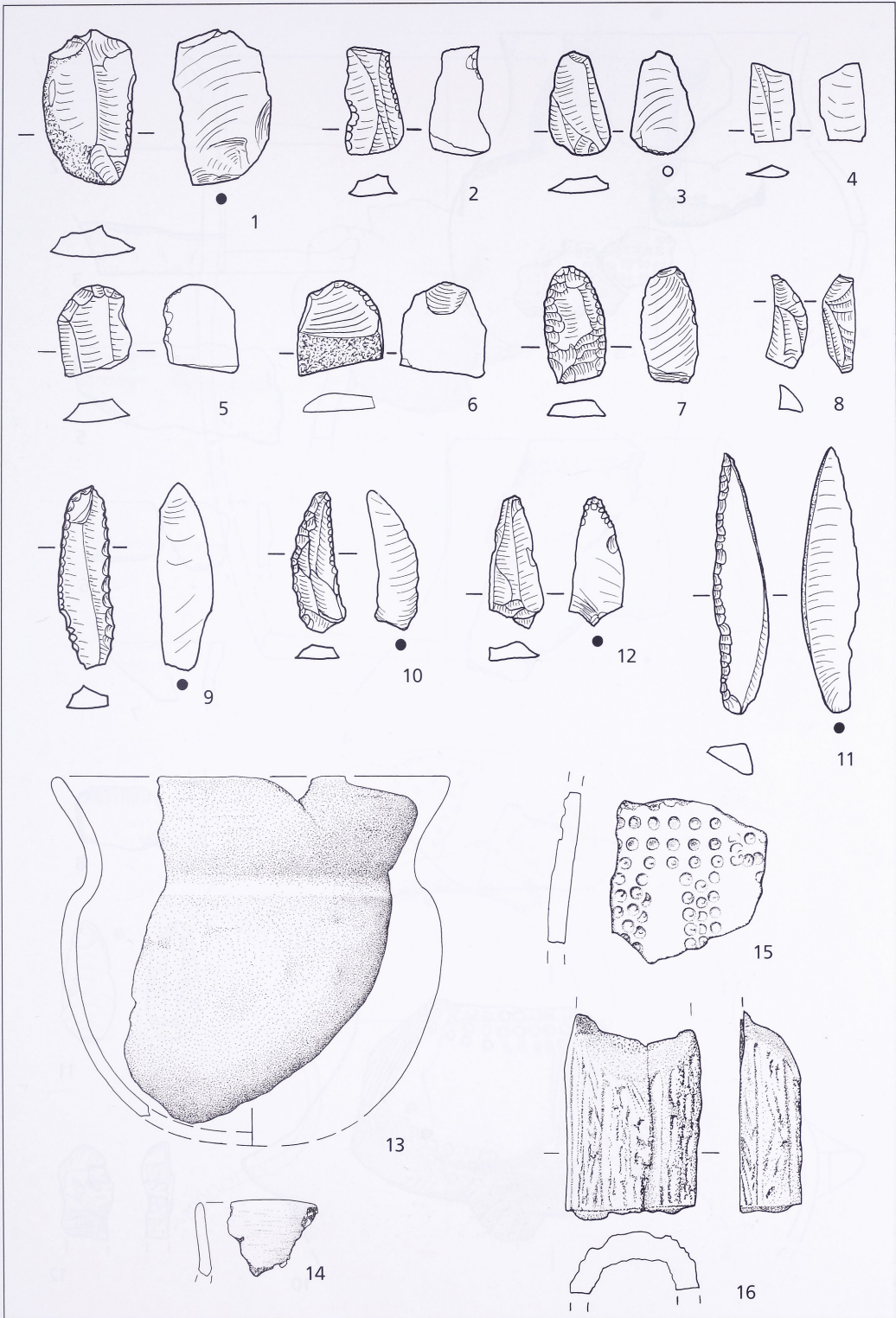

Riegel (Lkr. Emmendingen). Fdst. 2. 1-12 M 2:3; 13 u. 14 M 1:3; 15 u. 16 M 1:2.

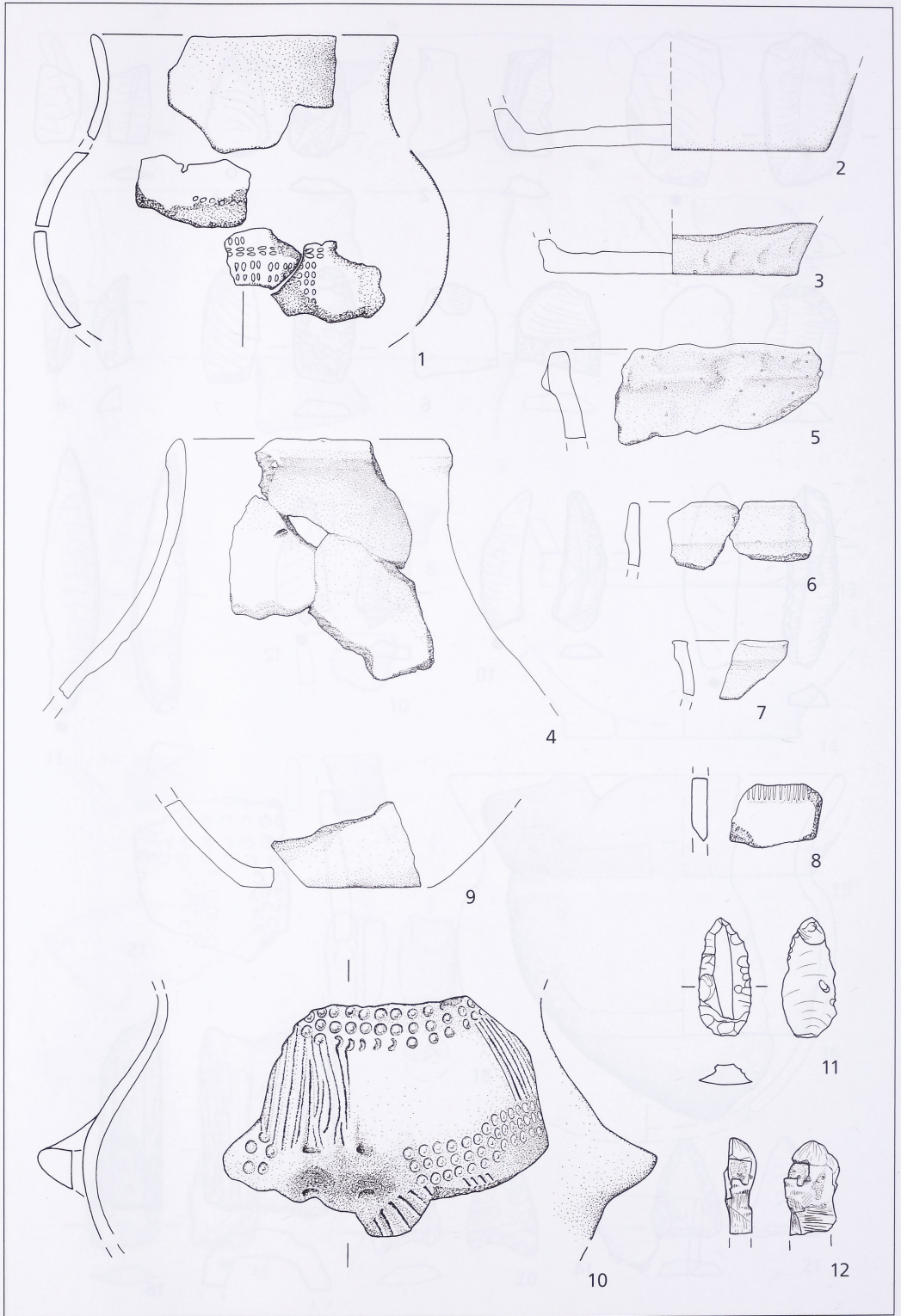

Riegel (Lkr. Emmendingen). Fdst. 2. 1.8.10-12 M 1:2; 2.3-7 u. 9 M 1:3.

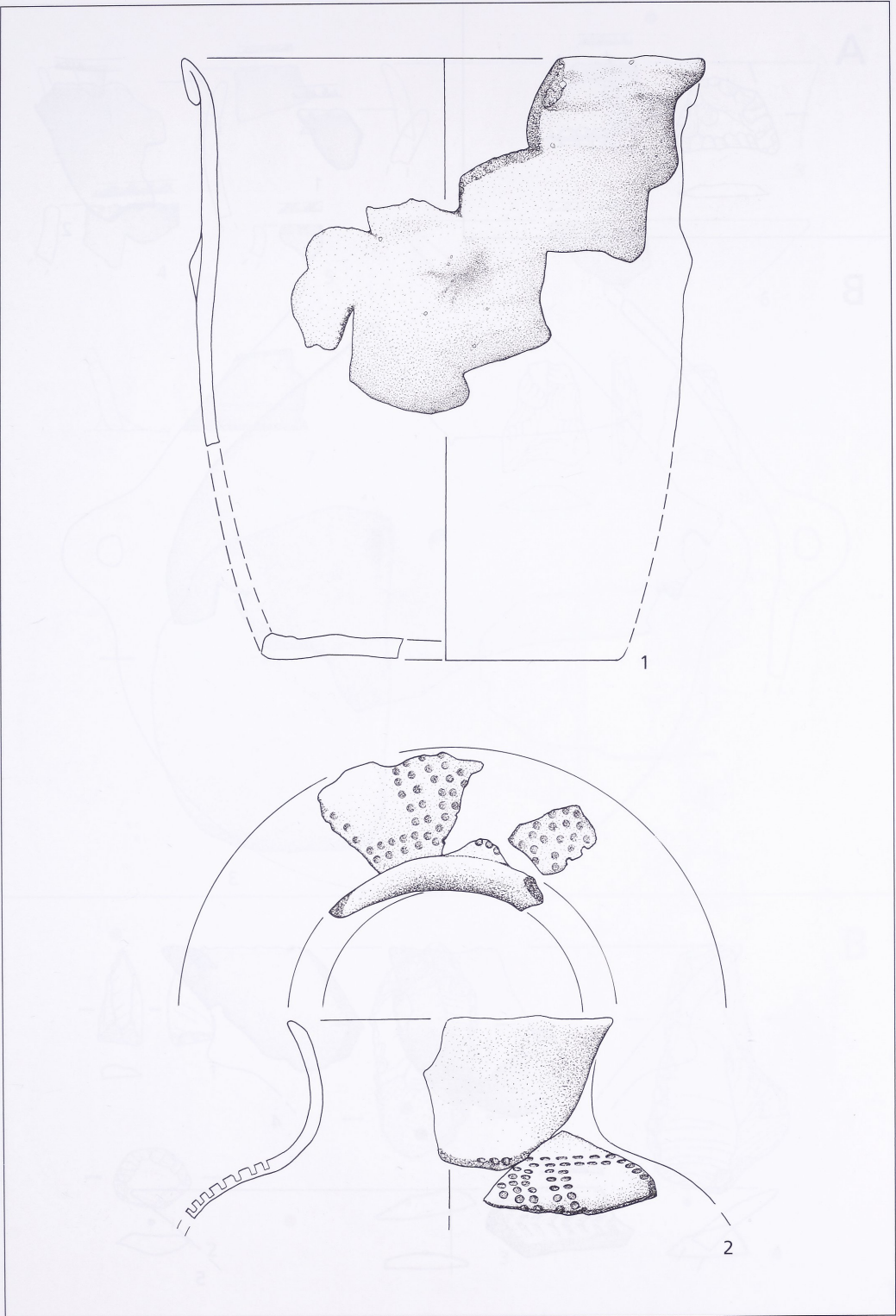

Riegel (Lkr. Emmendingen). Fdst. 2. 1 M 1:3; 2 M 1:2.

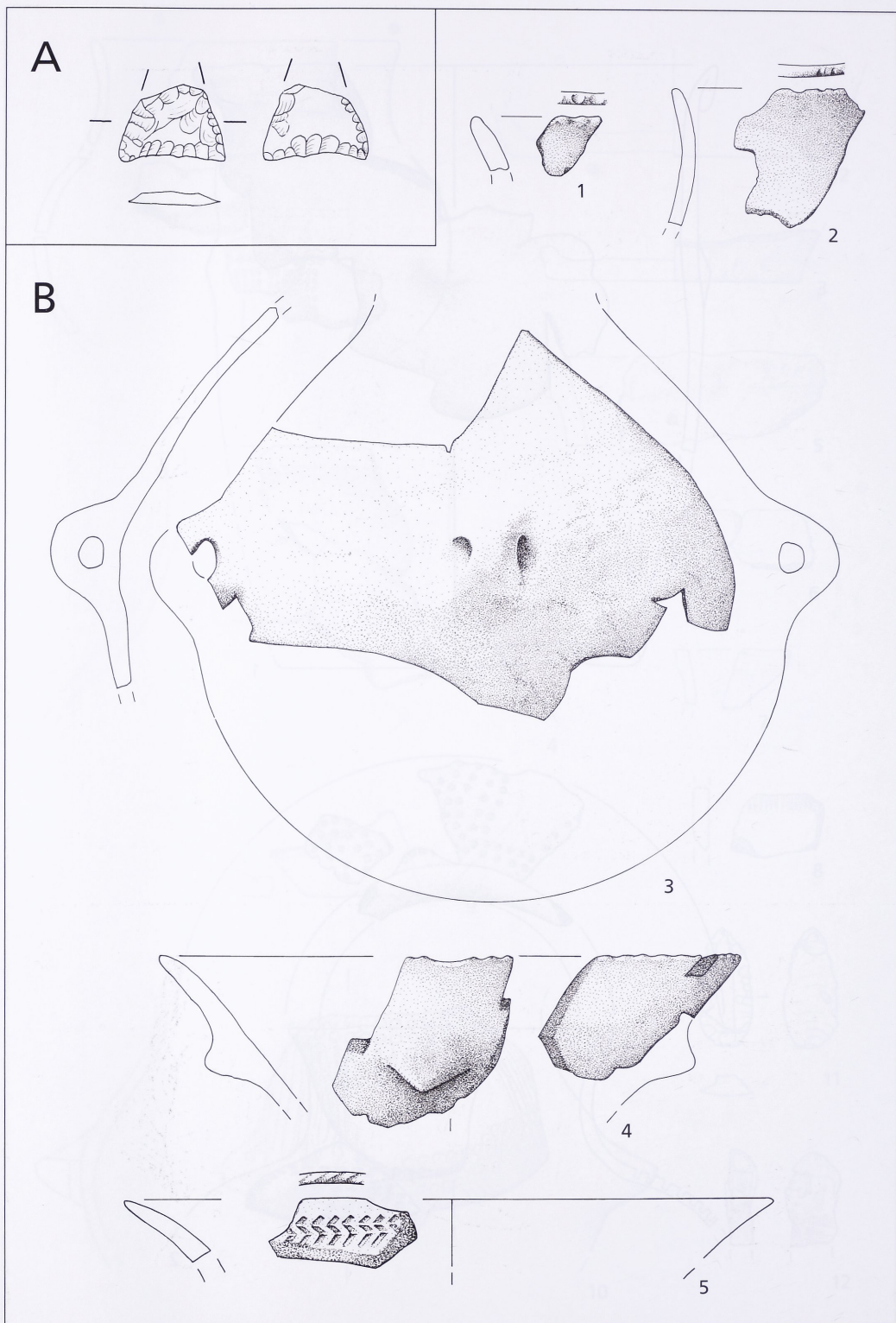

A Riegel (Lkr. Emmendingen). Fdst. 3. M 2:3. – B Riegel (Lkr. Emmendingen). Fdst. 4.
1–4 M 1:3; 5 M 1:2.

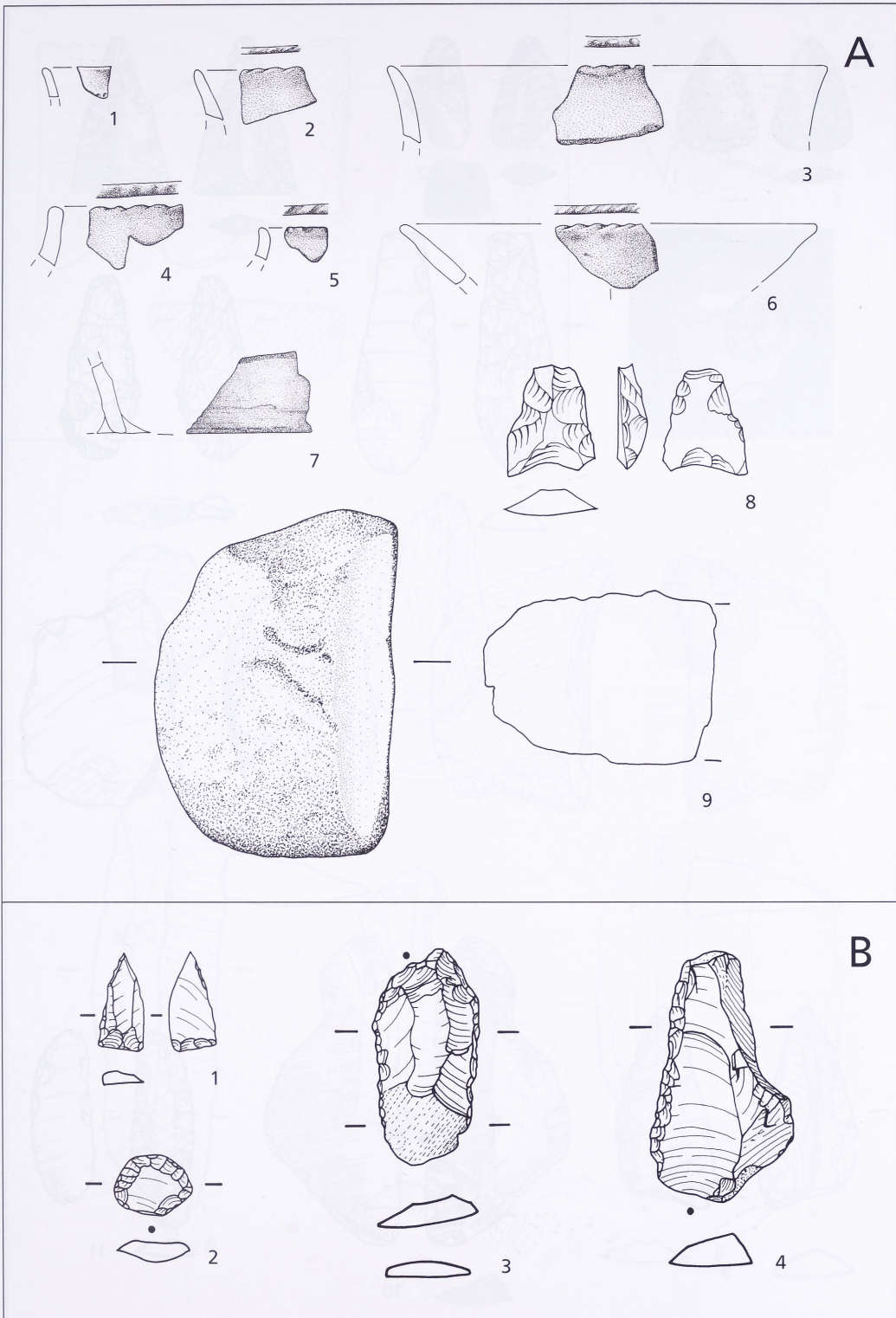

A Riegel (Lkr. Emmendingen). Fdst. 4. 1-7 M 1:3; 8 M 1:1; 9 M 1:2. -

B Schliengen Liel (Lkr. Lörrach). Fdst. „grün“. M 2:3.

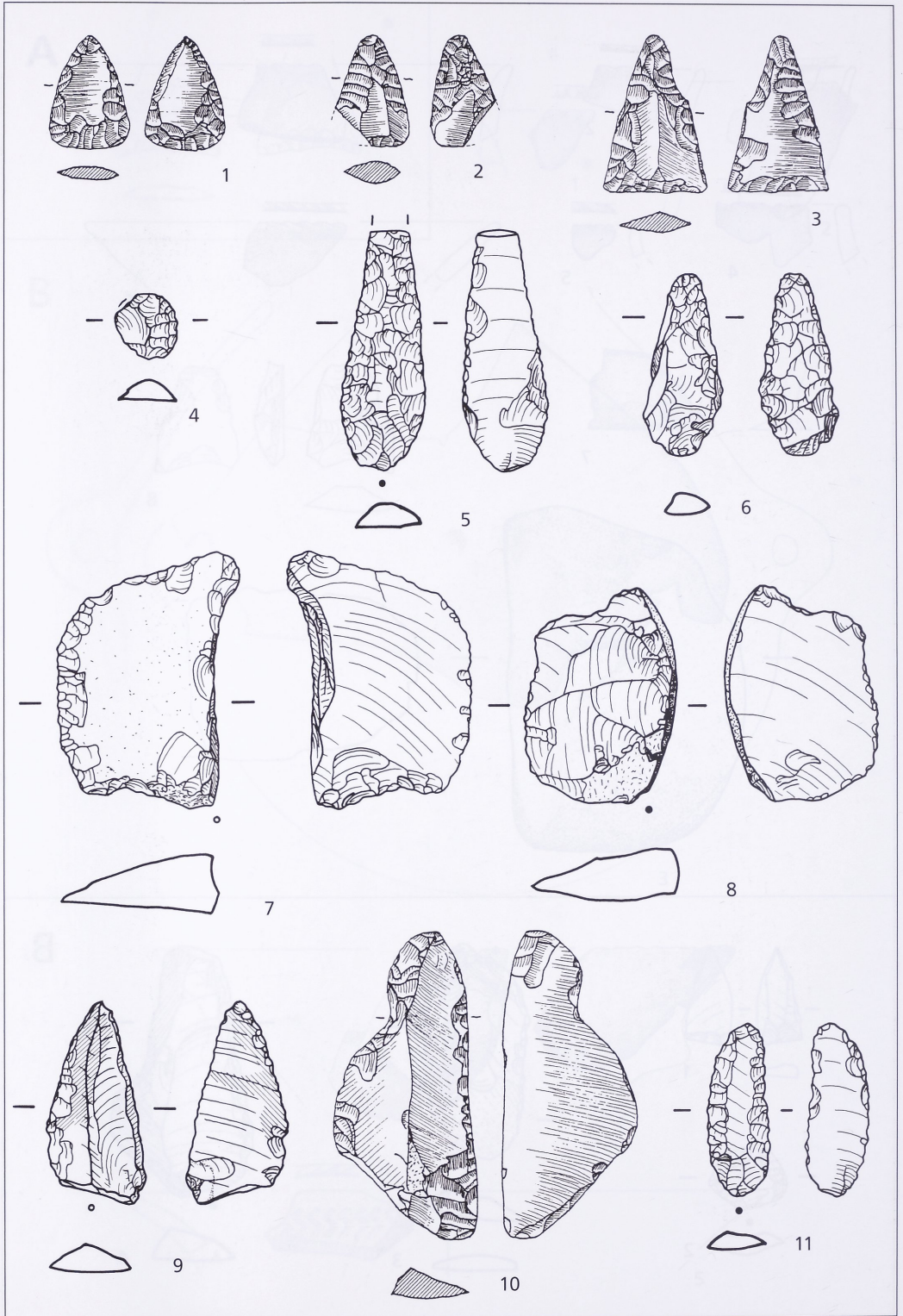

A Schliengen L i e l (Lkr. Lörrach). Fdst. ‚gelb‘. M 2:3.

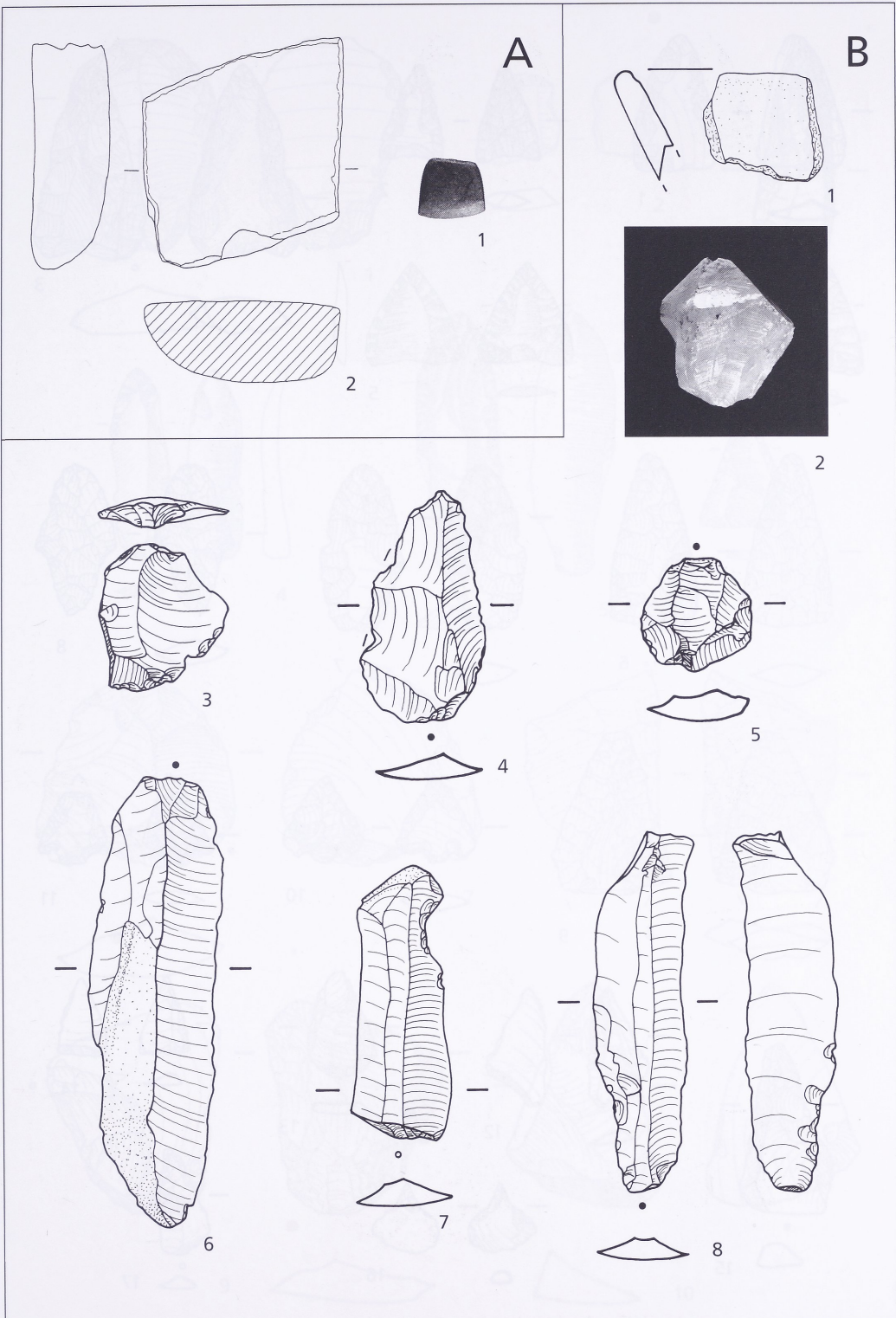

A Schliengen Liel (Lkr. Lörrach). Fdst. ,gelb'. 1 M 1:2; 2 M 1:4. –
 B Schliengen Liel (Lkr. Lörrach). Fdst. ,blau'. 1 M 1:2; 2–8 M 2:3.

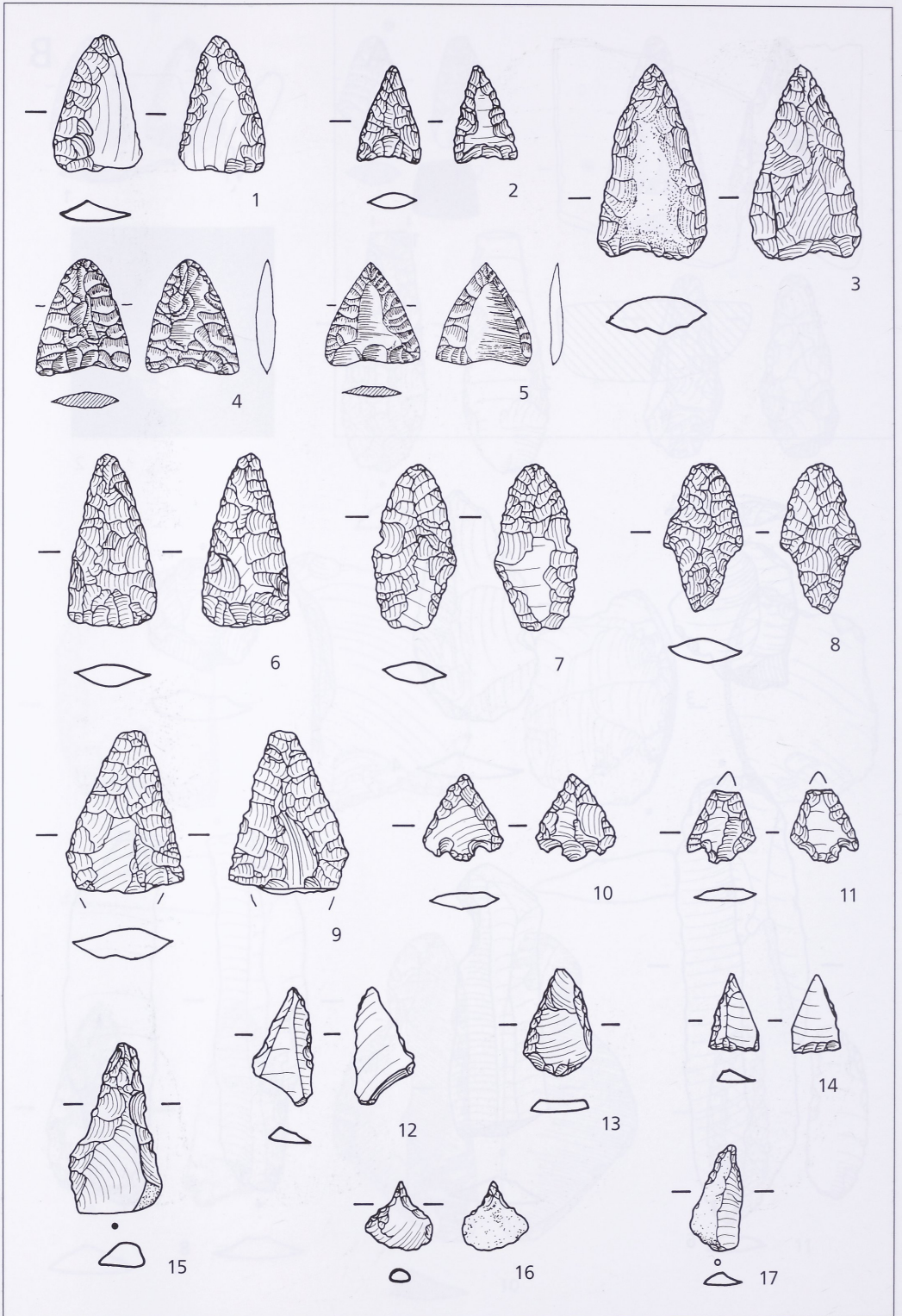

A Schliengen L i e l (Lkr. Lörrach). Fdst. ‚blau‘. M 2:3.

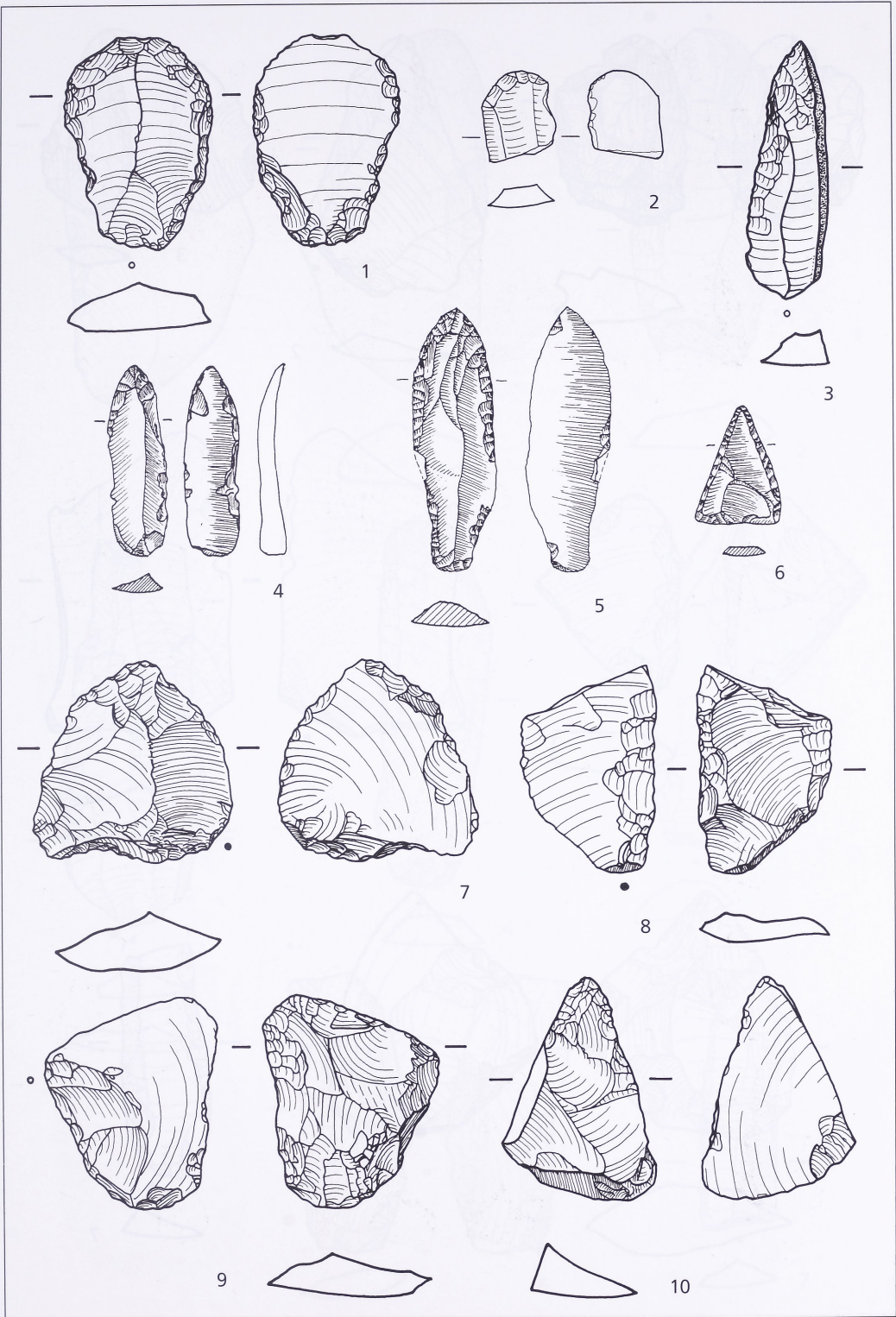

A Schliengen L i e l (Lkr. Lörrach). Fdst. ‚blau‘. M 2:3.

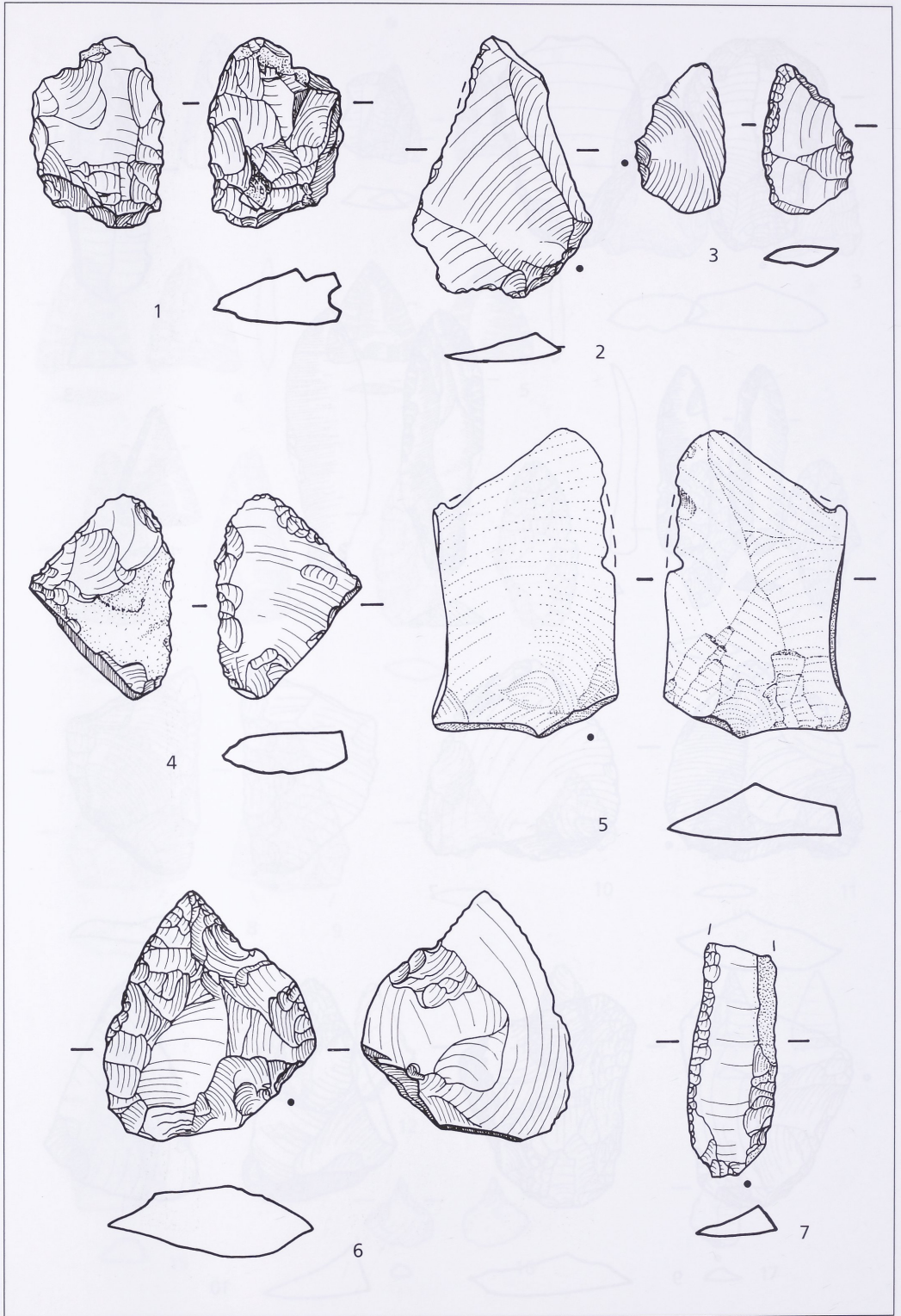

Schliengen Liel (Lkr. Lörrach). Fdst. ,blau'. M 2:3.

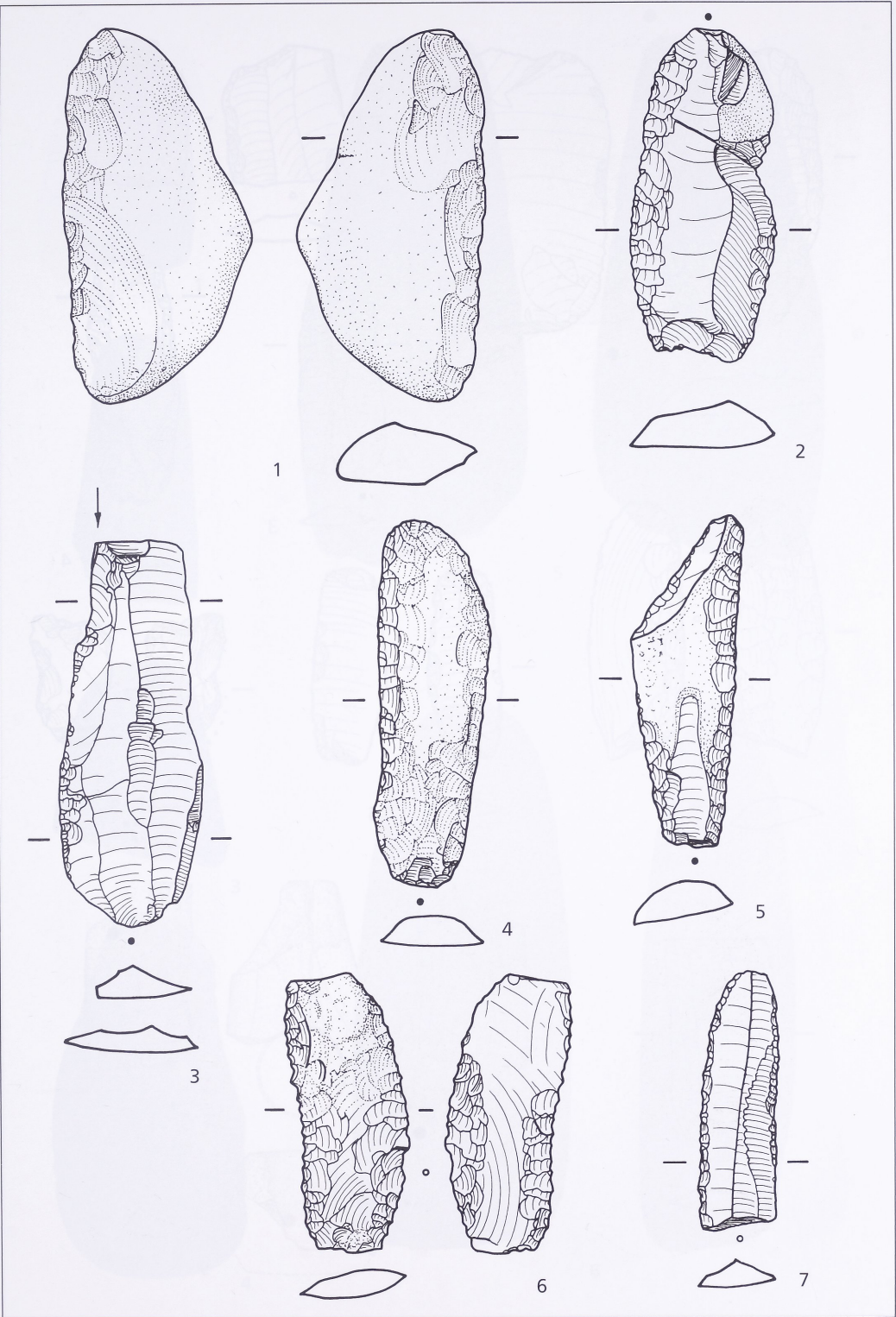

Schliengen L i e l (Lkr. Lörrach). Fdst. ‚blau‘. M 2:3.

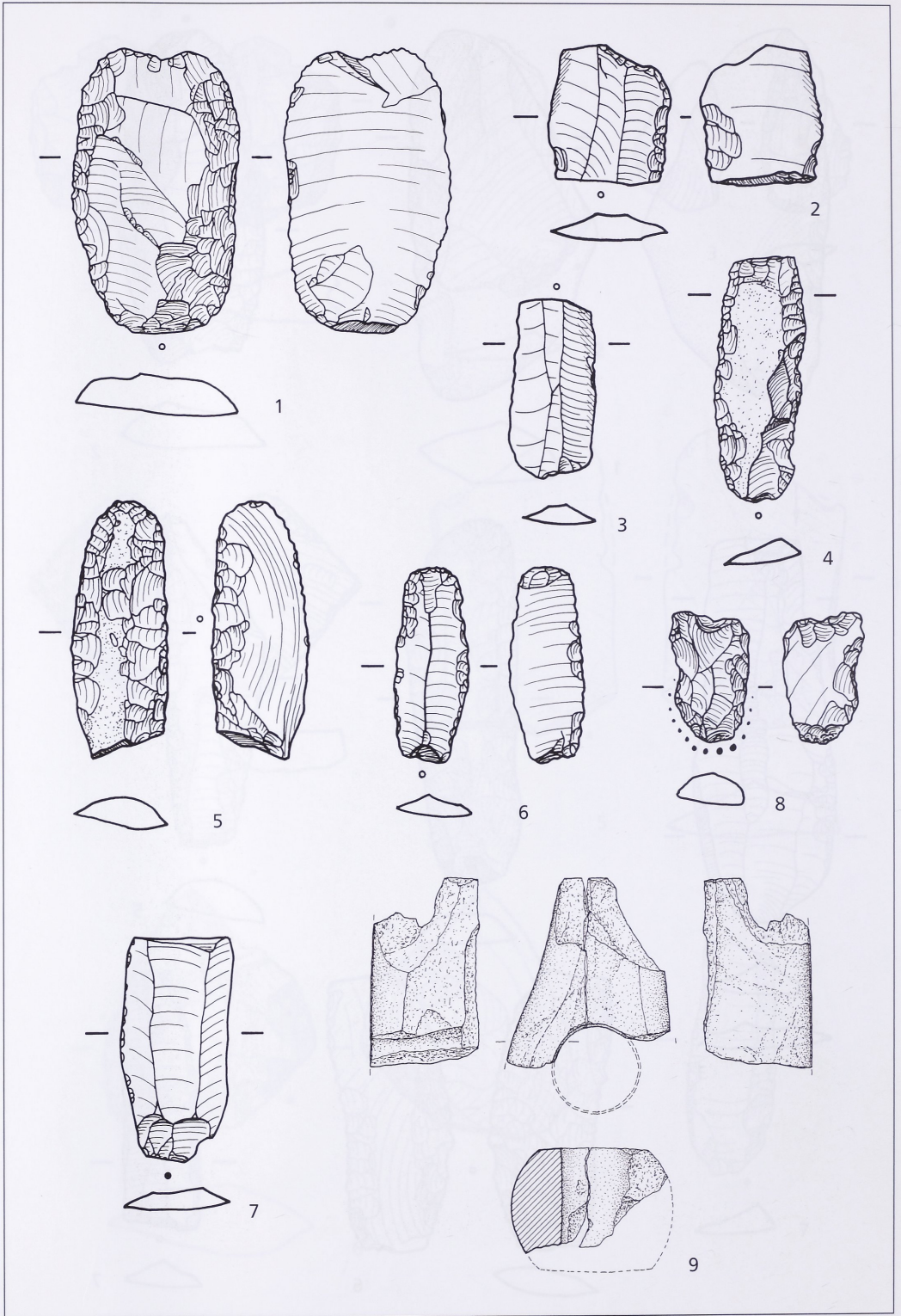

Schliengen L i e l (Lkr. Lörrach). Fdst. ,blau'. 1-8 M 2:3; 9 M 1:2.



Schliengen L i e l (Lkr. Lörrach). Fdst. ‚blau‘. M 1:2.

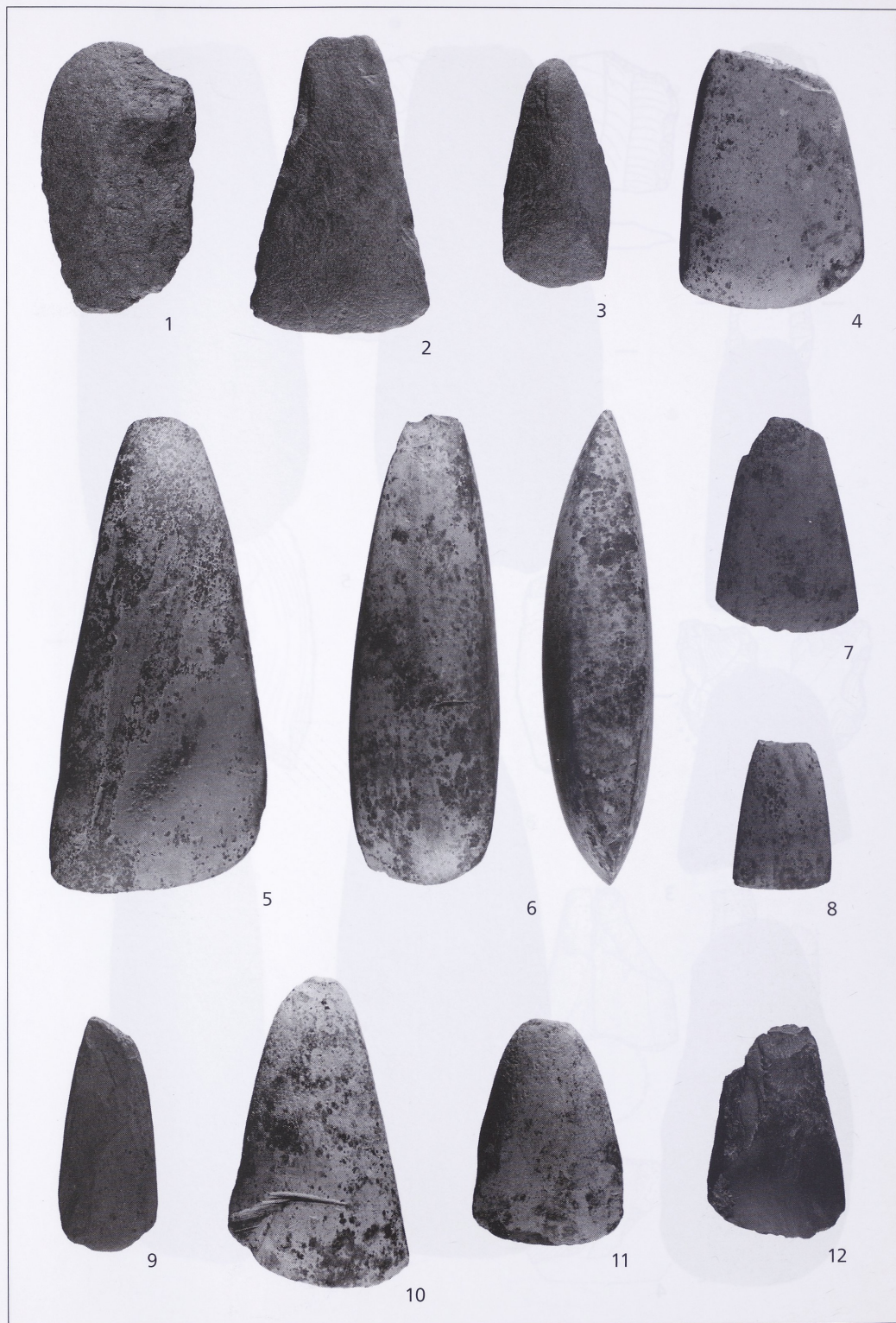

Schliengen L i e l (Lkr. Lörrach). Fdst. ‚blau‘. M 1 : 2.

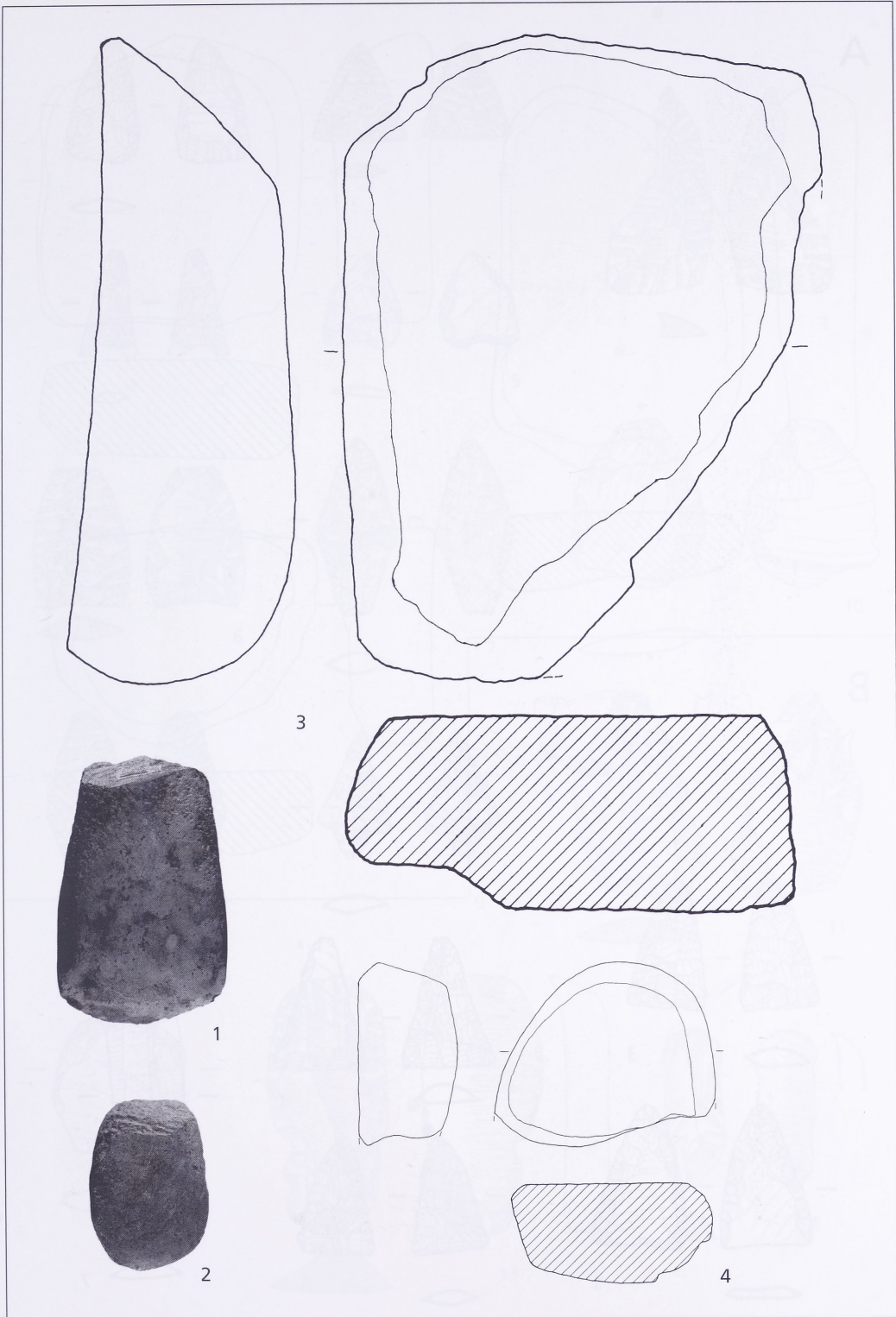

Schliengen L i e l (Lkr. Lörrach). Fdst. ‚blau‘. 1 u. 2 M 1:2; 3 M 1:5; 4 M 1:4.

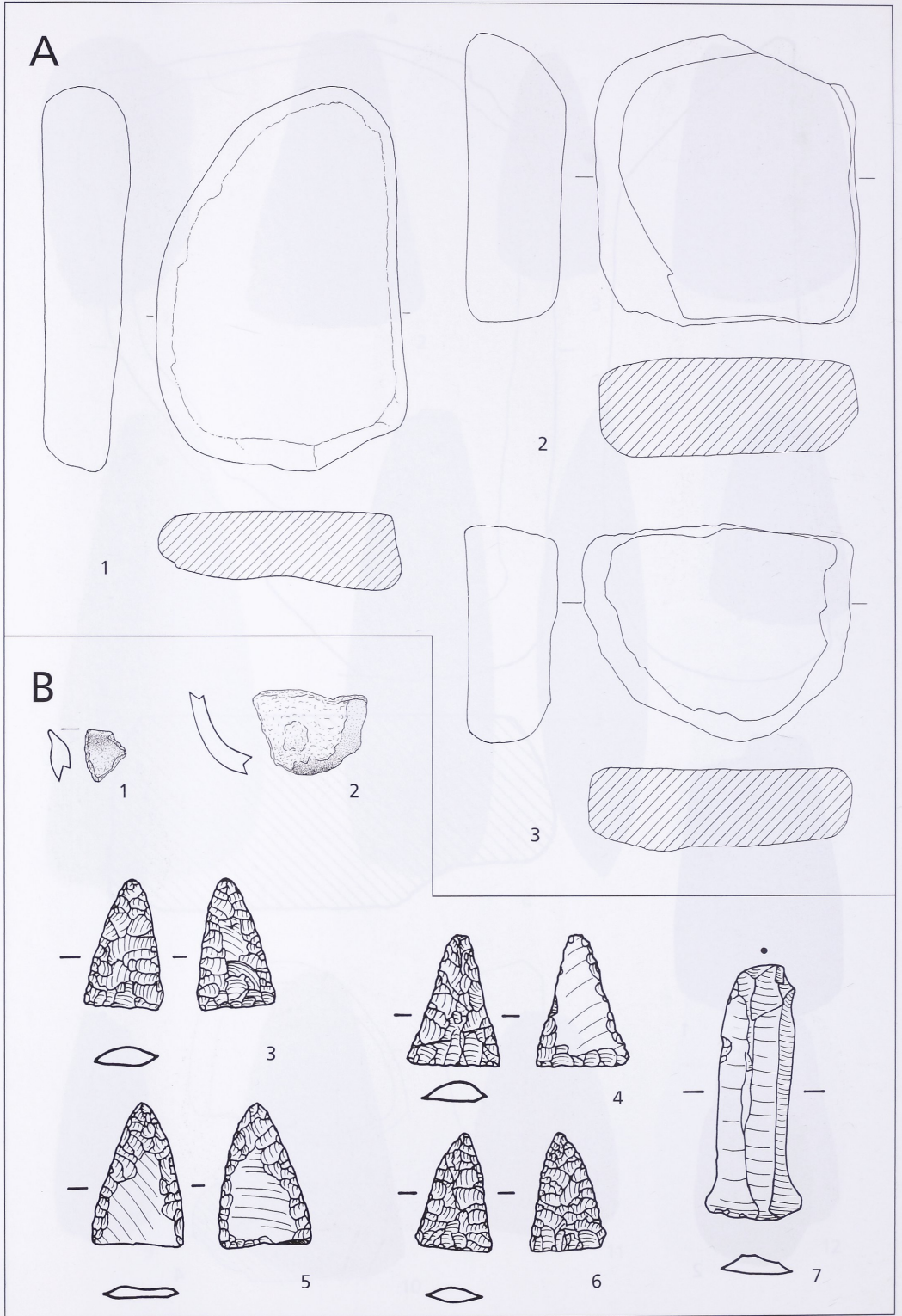

A Schliengen L i e l (Lkr. Lörrach). Fdst. ‚blau‘. M 1:4. – B Schliengen L i e l (Lkr. Lörrach). Fdst. ‚rot‘. 1 u. 2 M 1:3; 3–7 M 2:3.

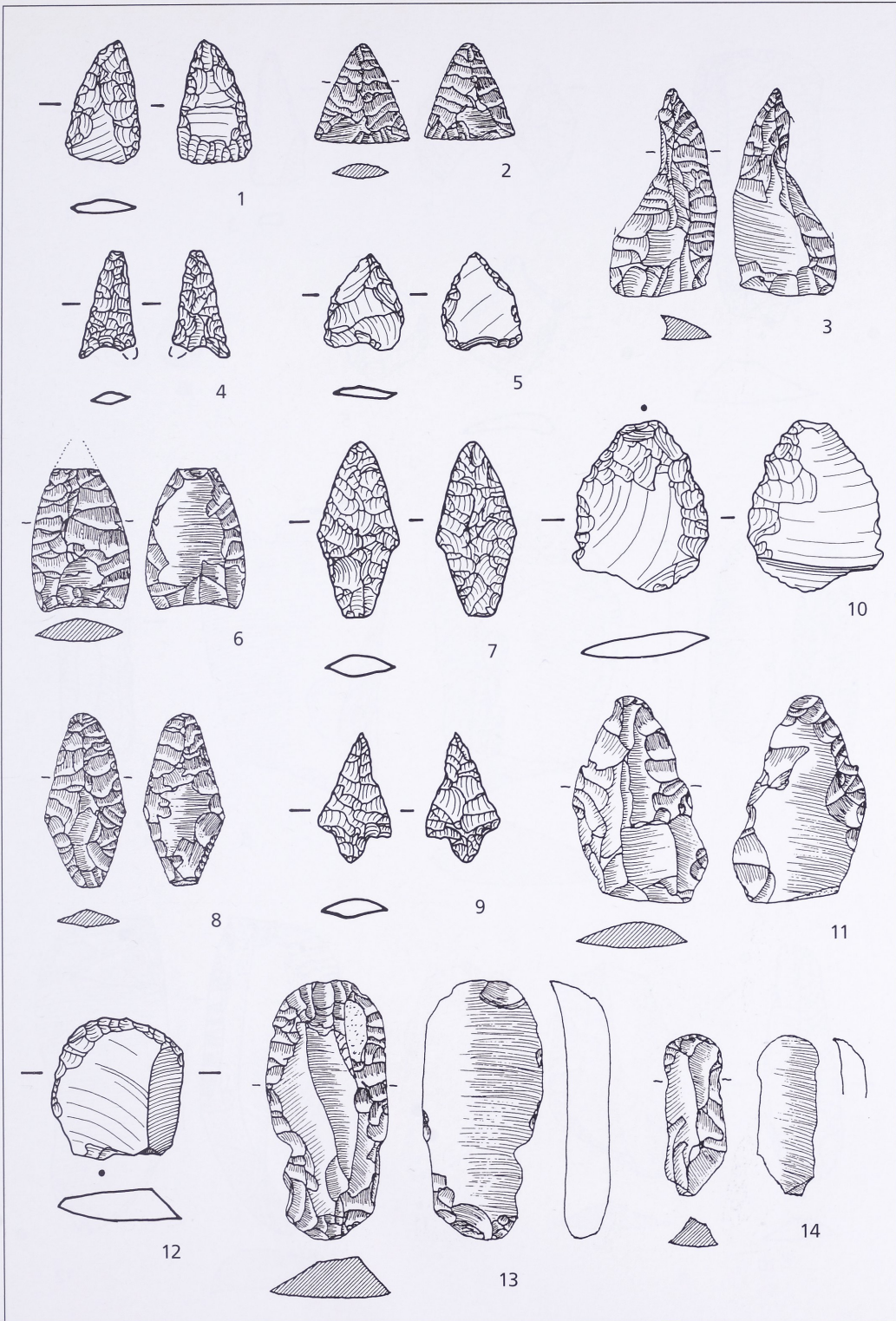

Schliengen L i e l (Lkr. Lörrach). Fdst. ,rot'. M 2:3.

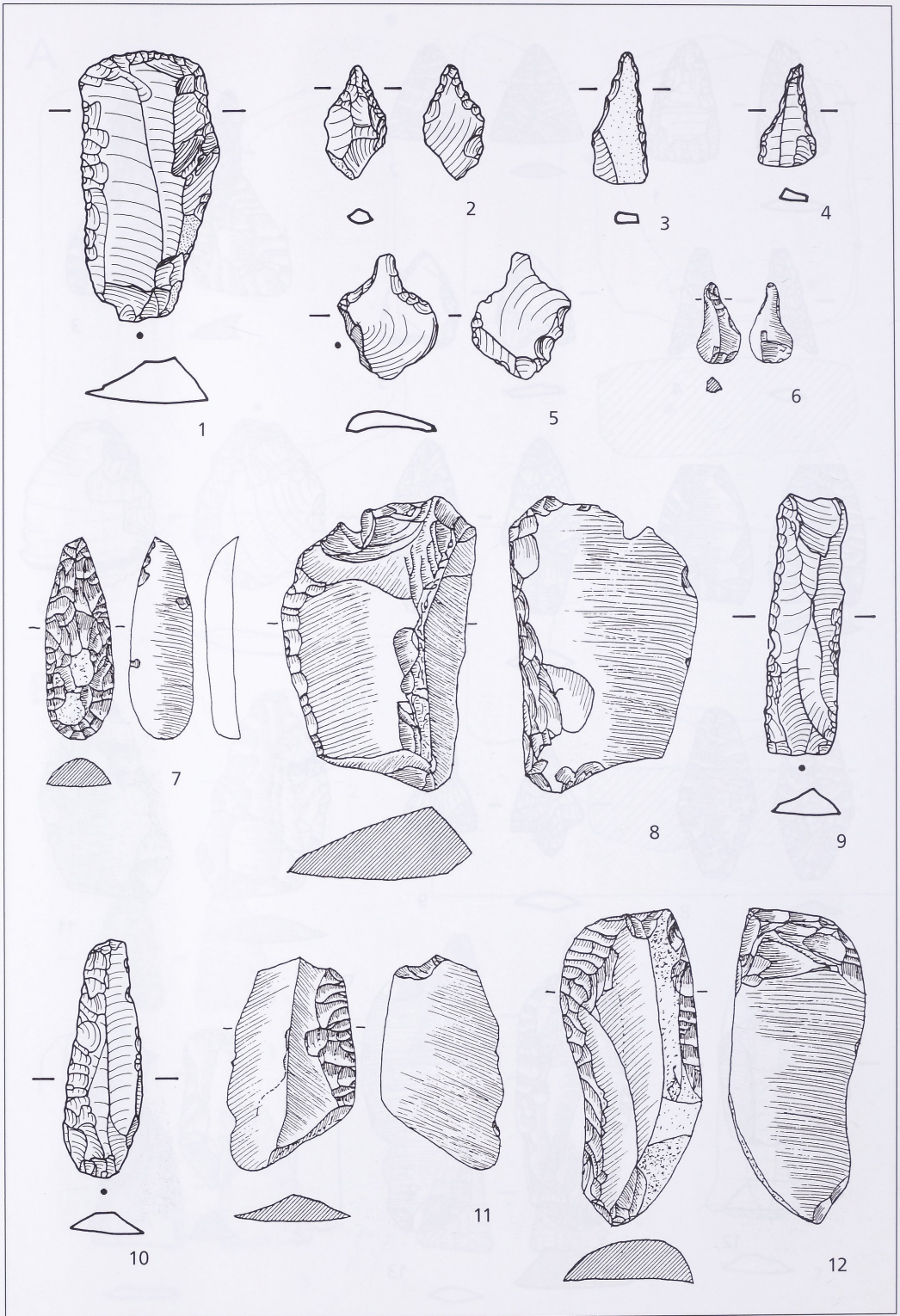

Schliengen L i e l (Lkr. Lörrach). Fdst. ,rot'. M 2:3.

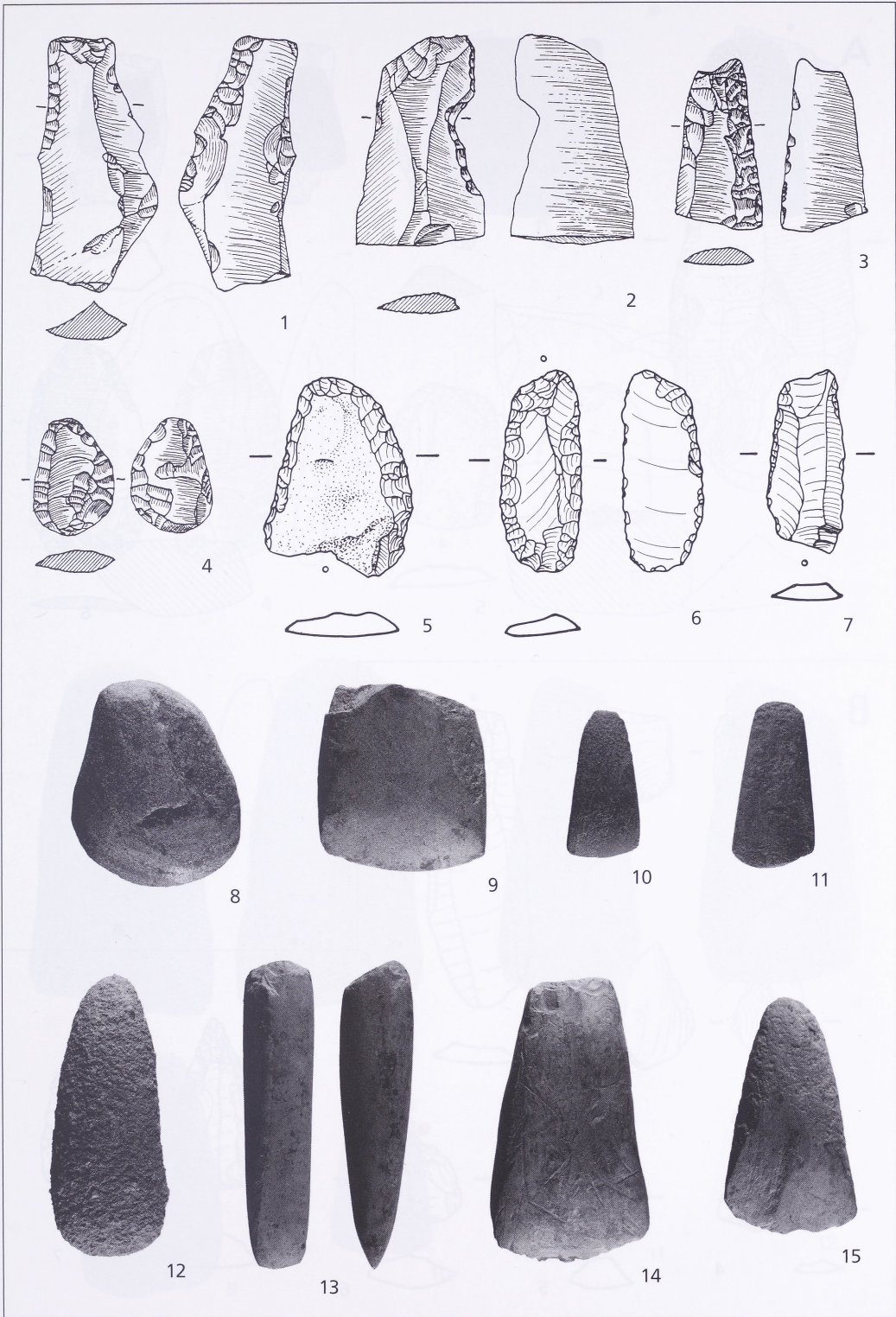

Schliengen Liel (Lkr. Lörrach). Fdst., rot. 1-7 M 2:3; 8-15 M 1:2.

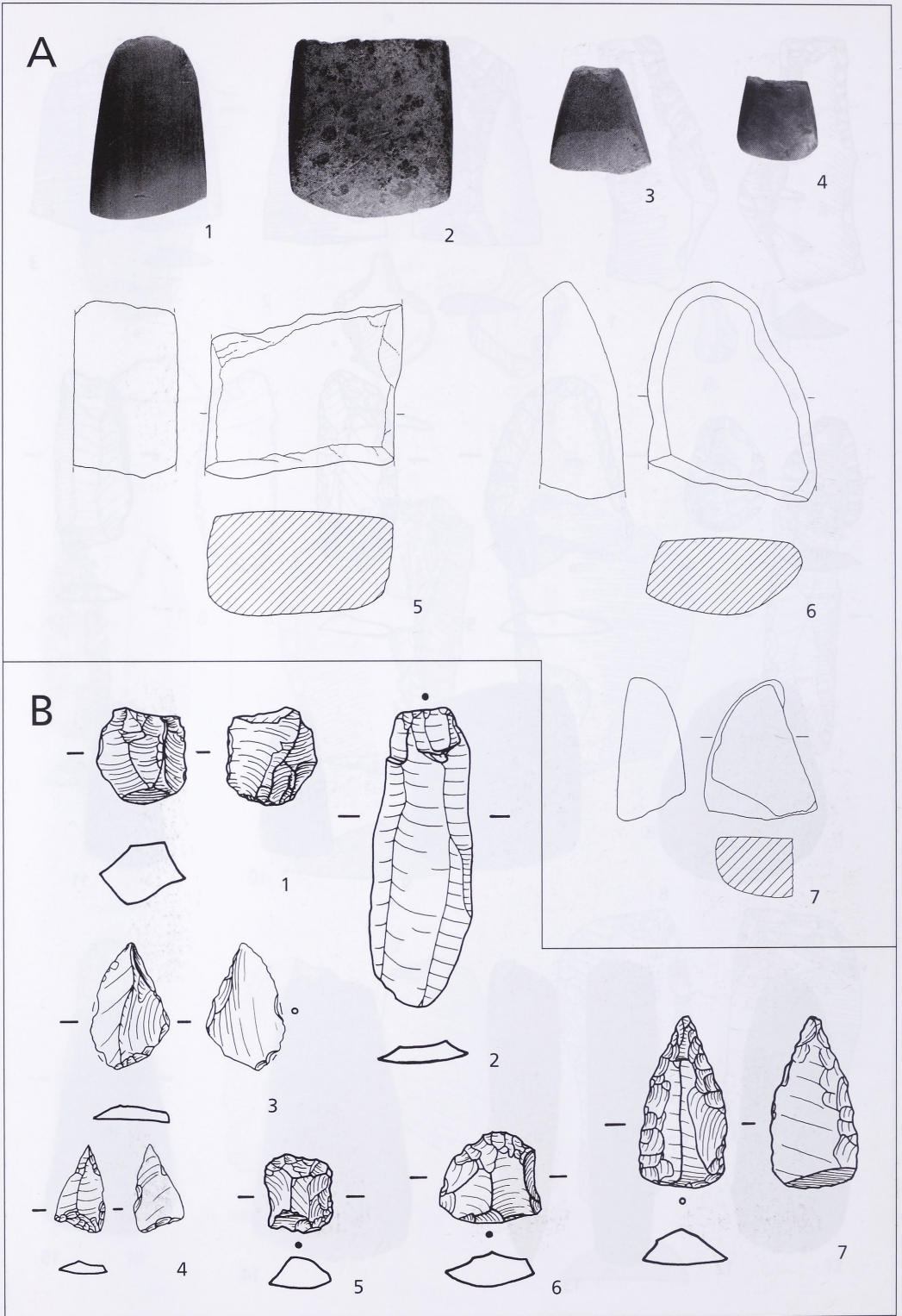

A Schliengen L i e l (Lkr. Lörrach). Fdst. ,rot'. 1-4 M 1:2; 5-7 M 1:4. -
 B Schliengen L i e l (Lkr. Lörrach). Fdst. ,lila'. M 2:3.

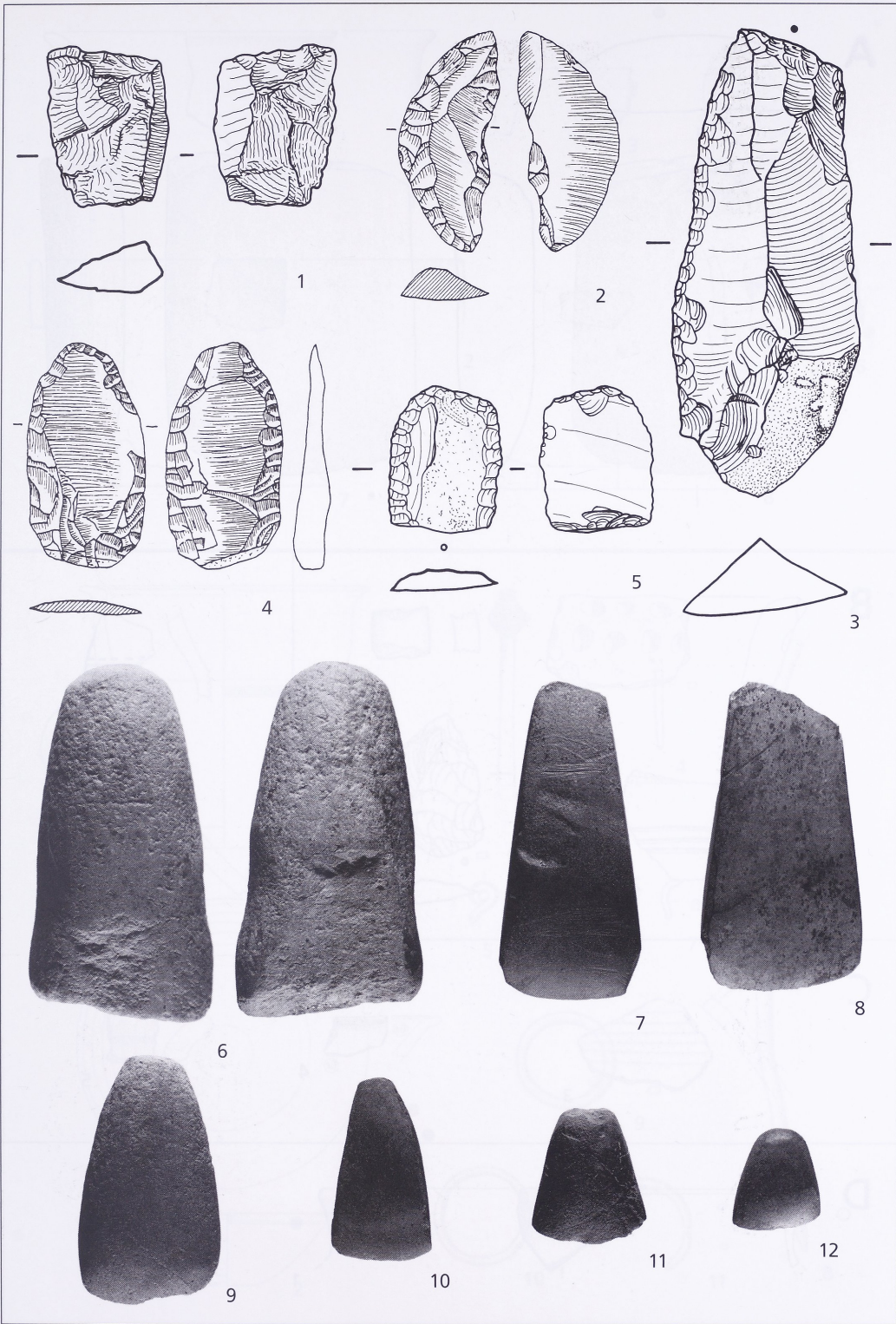

Schliengen L i e l (Lkr. Lörrach). Fdst. ‚lila‘. 1-5 M 2:3; 6-12 M 1:2.

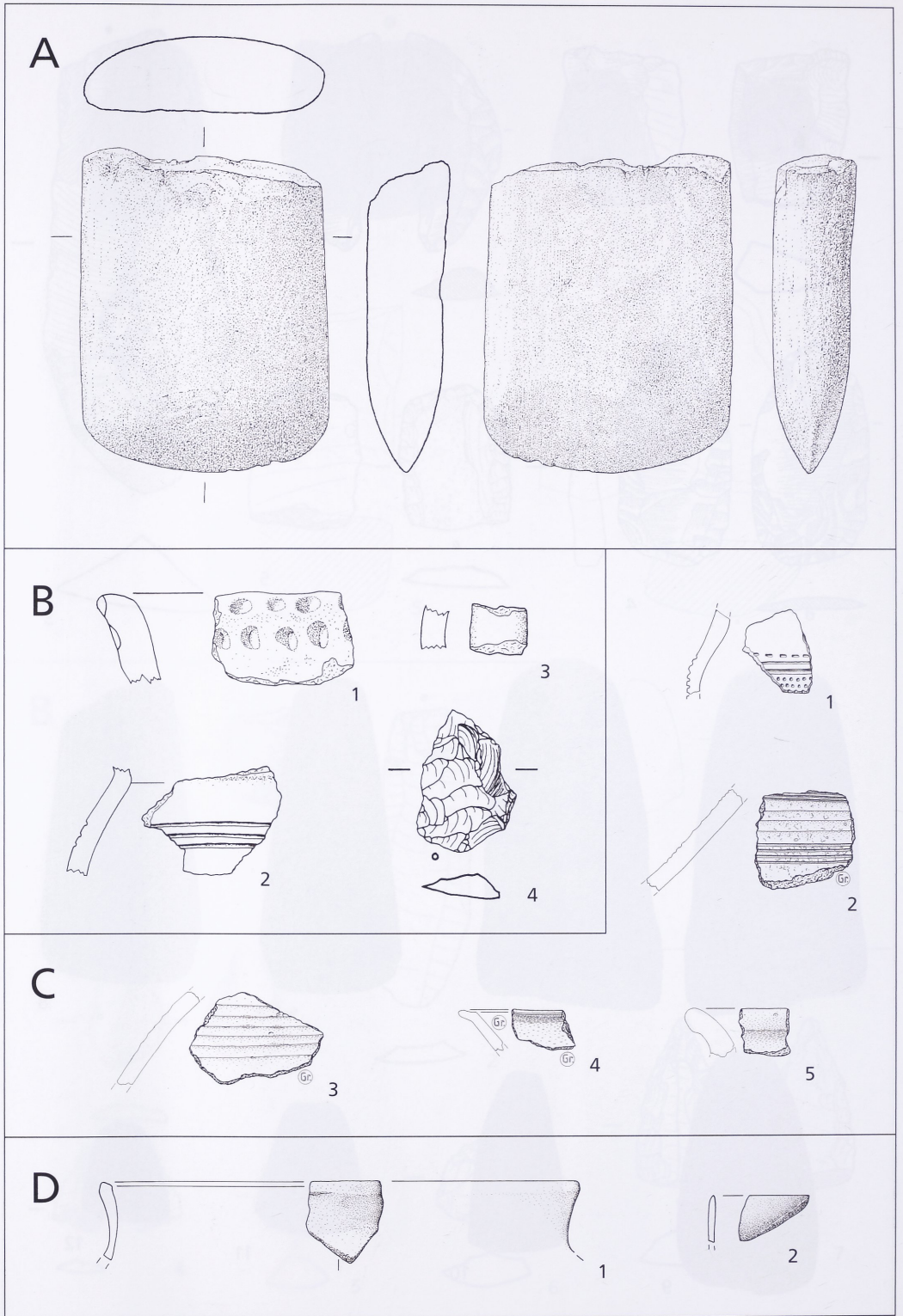

A Weissach im Tal (Rems-Murr-Kreis). M 1:2. – B Bad Bellingen Rheinweiler (Lkr. Lörrach). 1–3 M 1:2; 4 M 2:3. – C Bopfingen (Ostalbkreis). M 1:3. – D Eichstetten (Lkr. Breisgau-Hochschwarzwald). M 1:3.

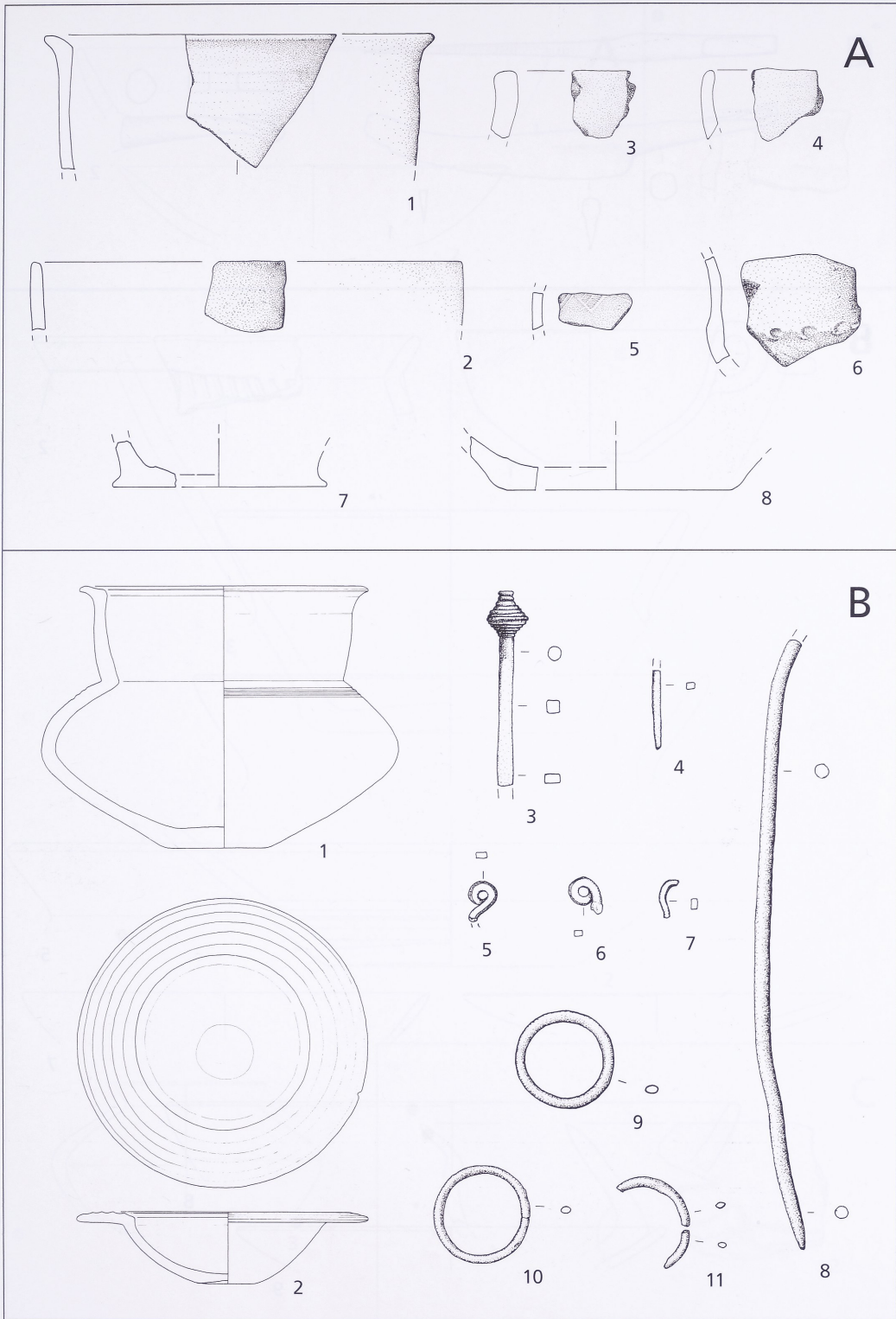

A Eichstetten (Lkr. Breisgau-Hochschwarzwald). M 1:3. – B Kirchheim unter Teck
(Lkr. Esslingen). 1 u. 2 M 1:3; 3–11 M 2:3.

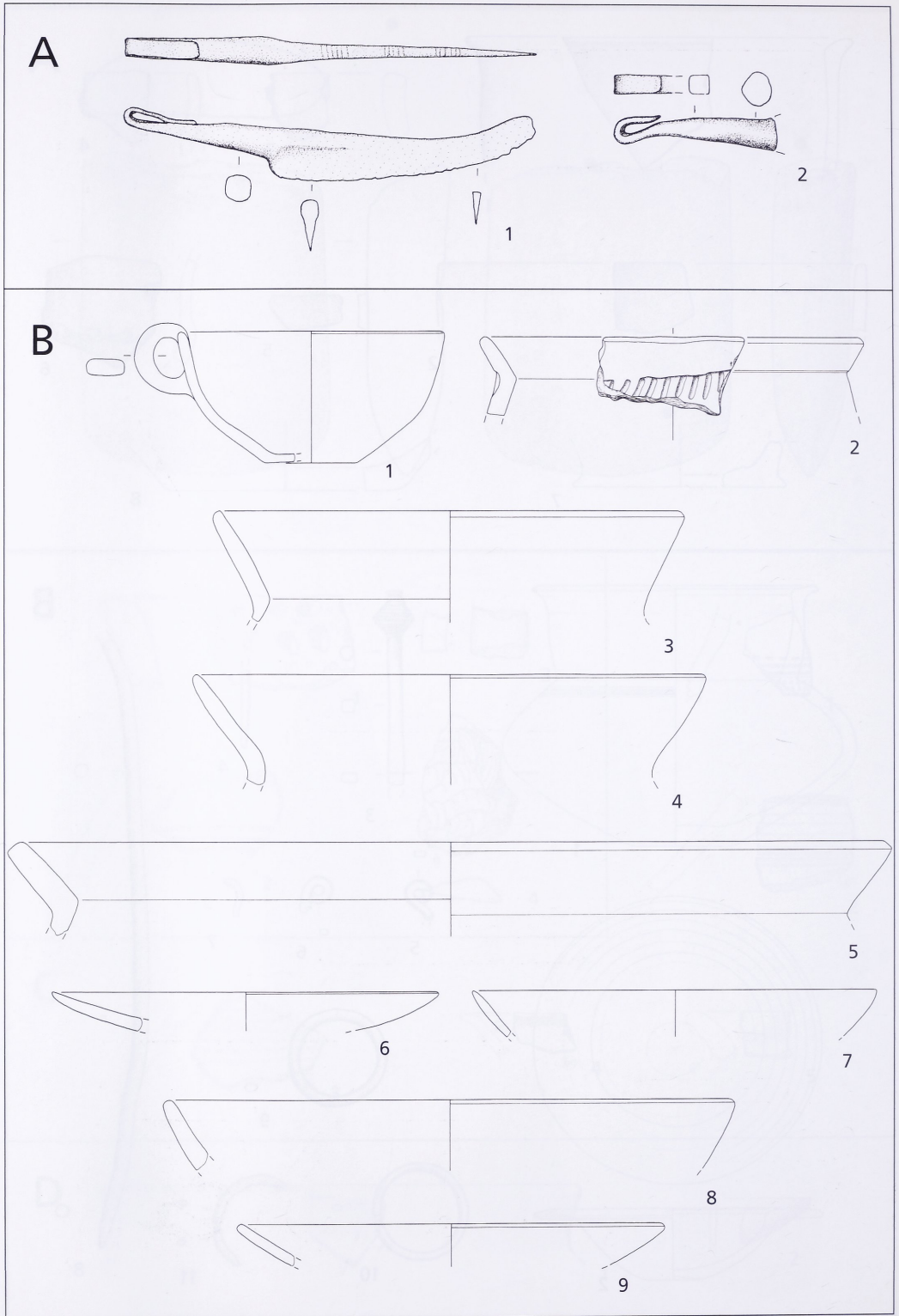

A Kirchheim unter Teck (Lkr. Esslingen). M 2:3. – B Neuhausen auf den Fildern (Lkr. Esslingen).
Fdst. 2. M 1:3.

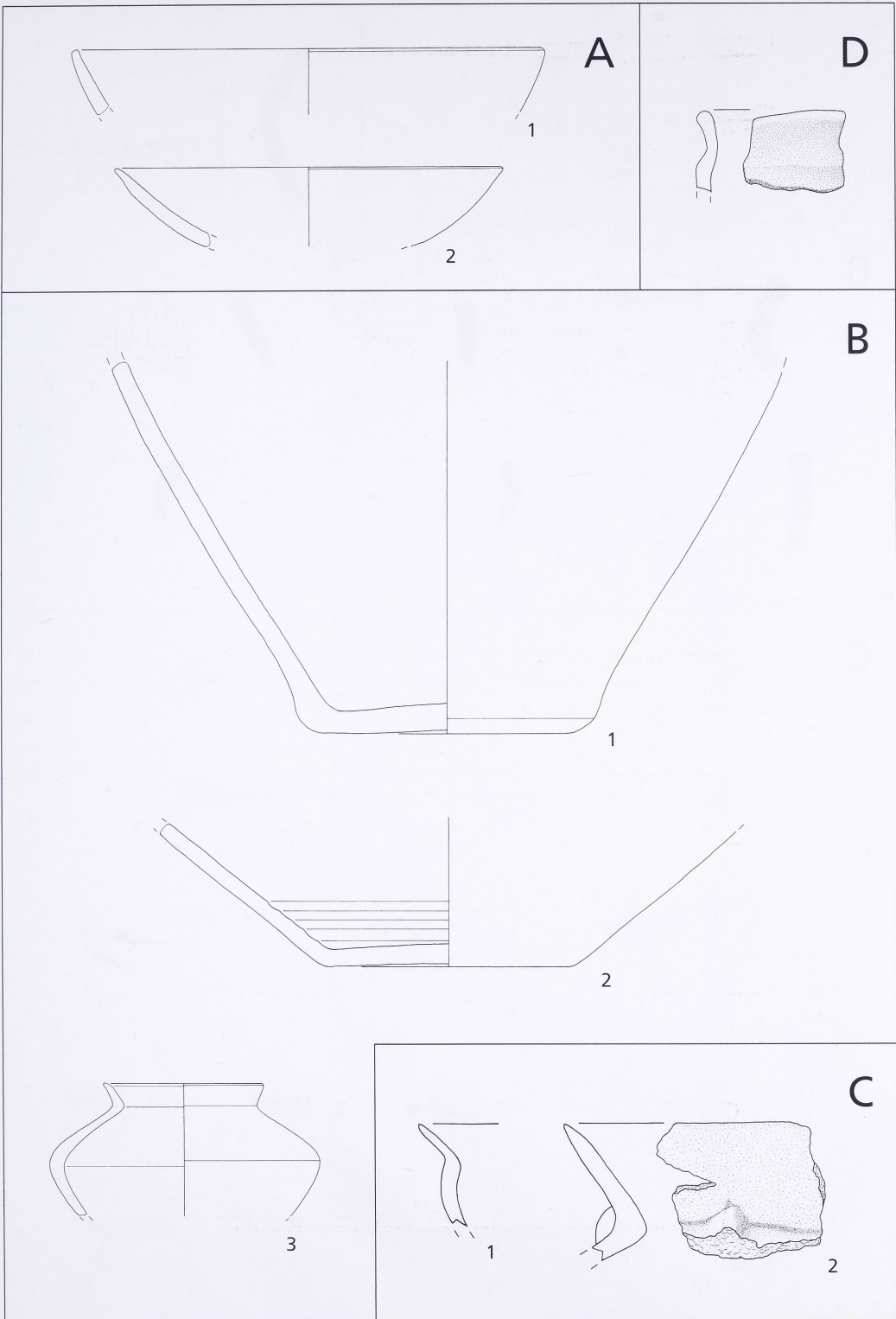

A Neuhausen auf den Fildern (Lkr. Esslingen). Fdst. 2. M 1:3. – B Nürtingen H a r d t (Lkr. Esslingen). M 1:3. – C Bad Bellingen H e r t i n g e n (Lkr. Lörrach). M 1:3. – D E nd i n g e n a m K a i s e r s t u h l K ö n i g s c h a f f h a u s e n (Lkr. Emmendingen). M 1:3.

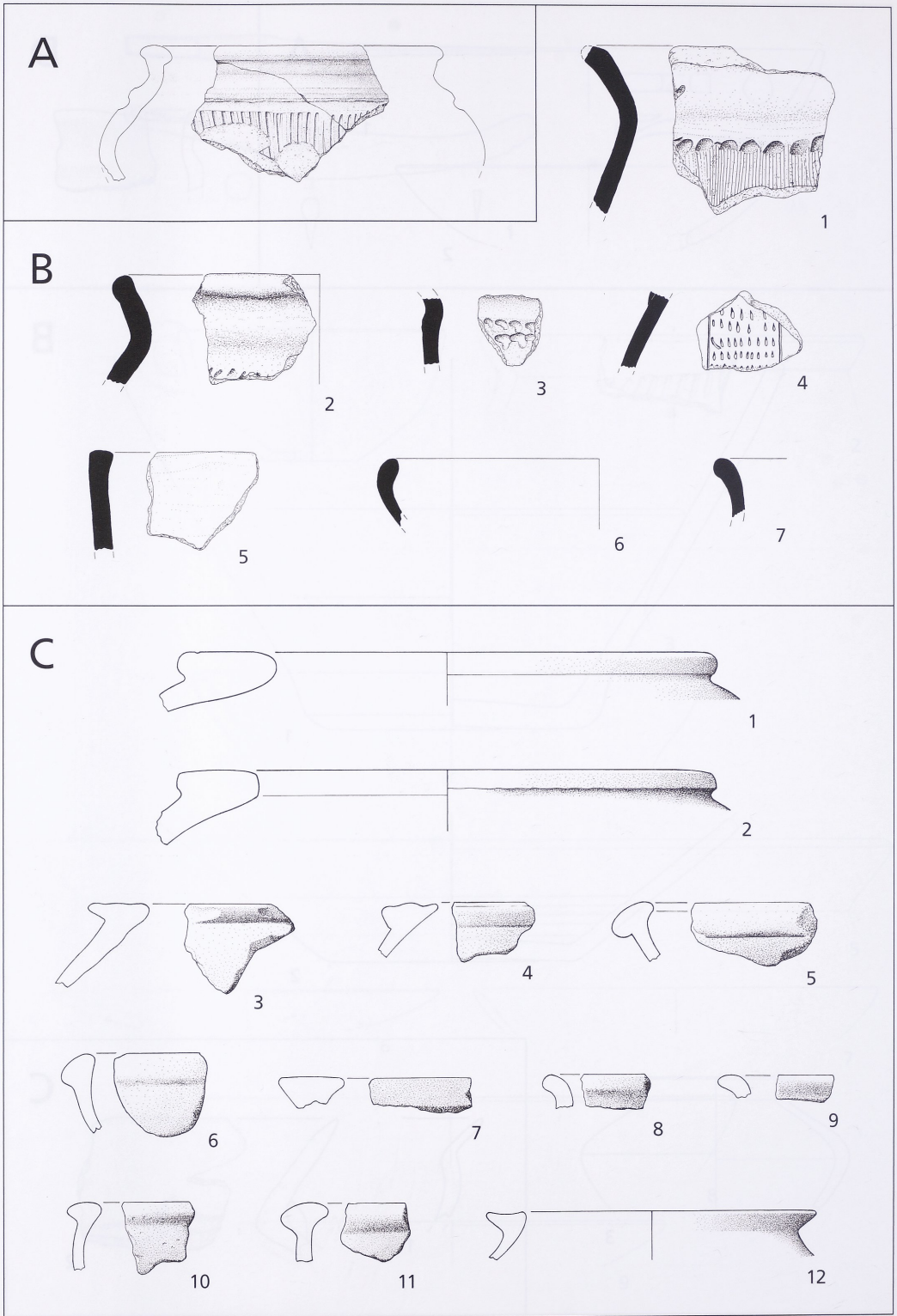

A Bopfingen Oberdorf am Ipf (Ostalbkreis). M 1:3. - B Efringen-Kirchen Blansingen (Lkr. Lörrach). M 1:3. - C Ehrenkirchen Ehrenstetten (Lkr. Breisgau-Hochschwarzwald). M 1:3.

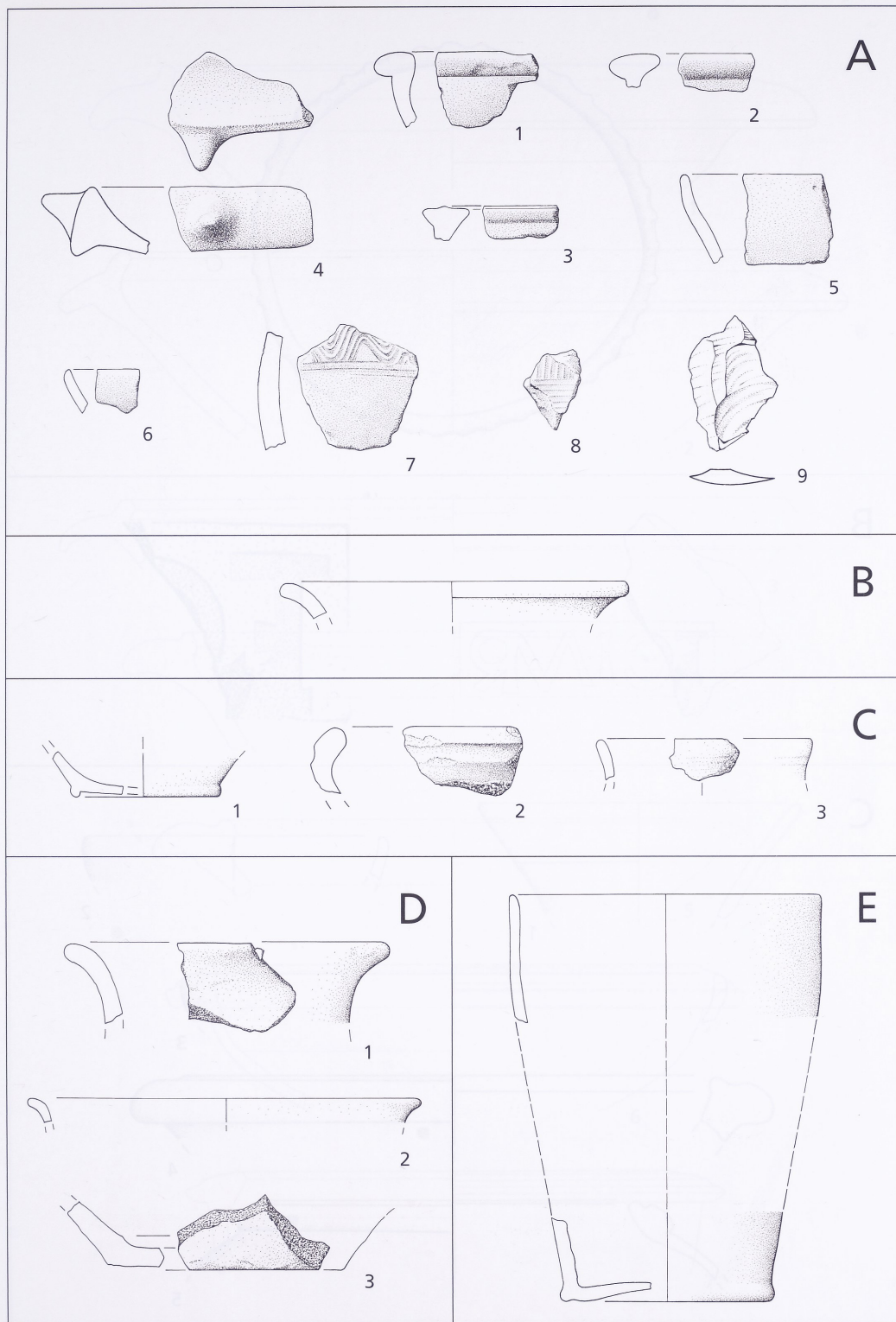

A Ehrenkirchen Ehrenstetten (Lkr. Breisgau-Hochschwarzwald). 1–8 M 1:3; 9 M 1:2. –
 B Forchheim (Lkr. Emmendingen). Fdst. 1. M 1:3. – C Forchheim (Lkr. Emmendingen). Fdst. 2.
 M 1:3. – D Forchheim (Lkr. Emmendingen). Fdst. 3. M 1:3. – E Riegel (Lkr. Emmendingen).
 M 1:3.

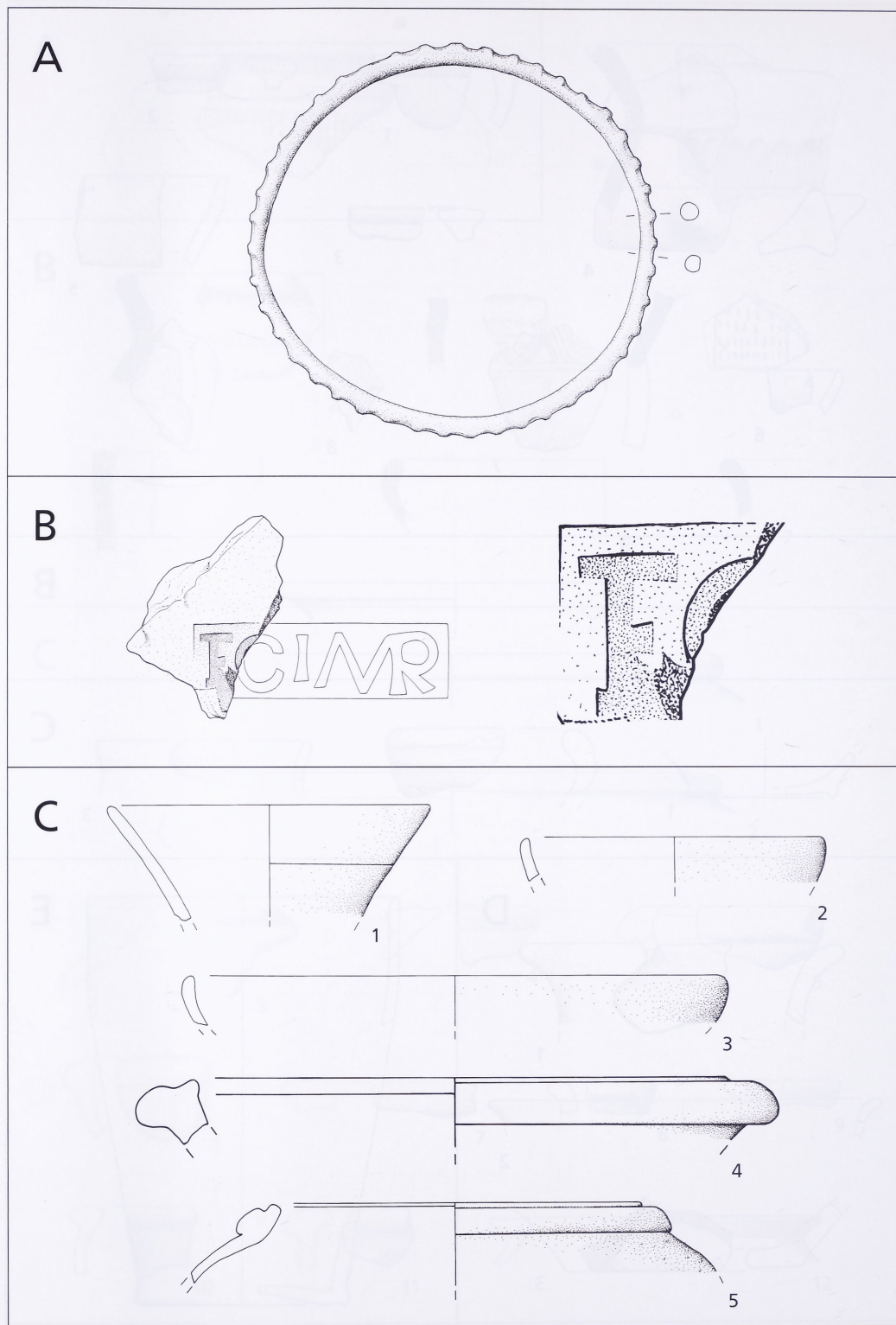

A Oberboihingen (Lkr. Esslingen). M 1:2. – B Bad Säckingen (Lkr. Waldshut). M 1:3;
 Stempel M 1:1. – C Forchheim (Lkr. Emmendingen). M 1:3.

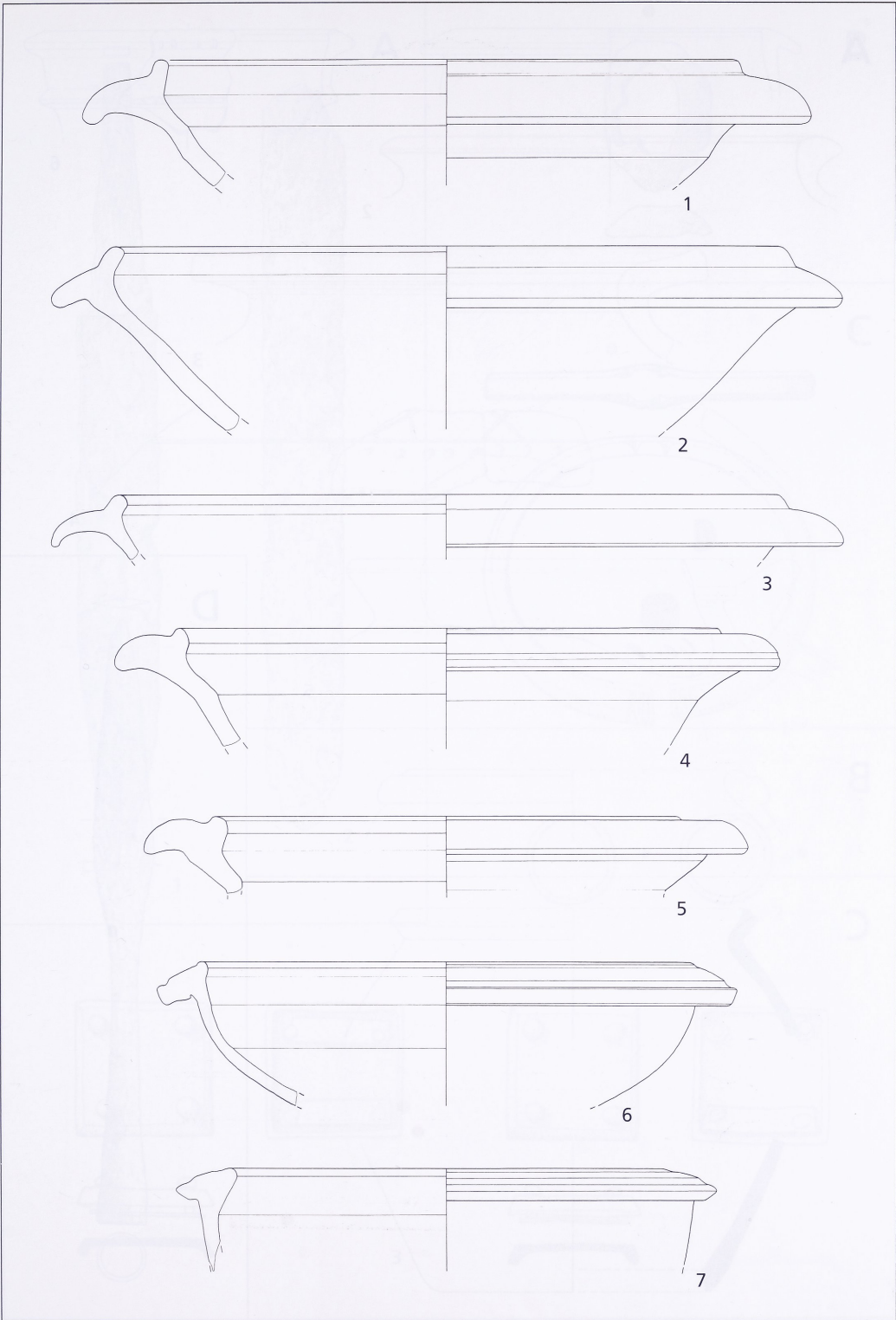

Reichenbach an der Fils (Lkr. Esslingen). M 1:3.

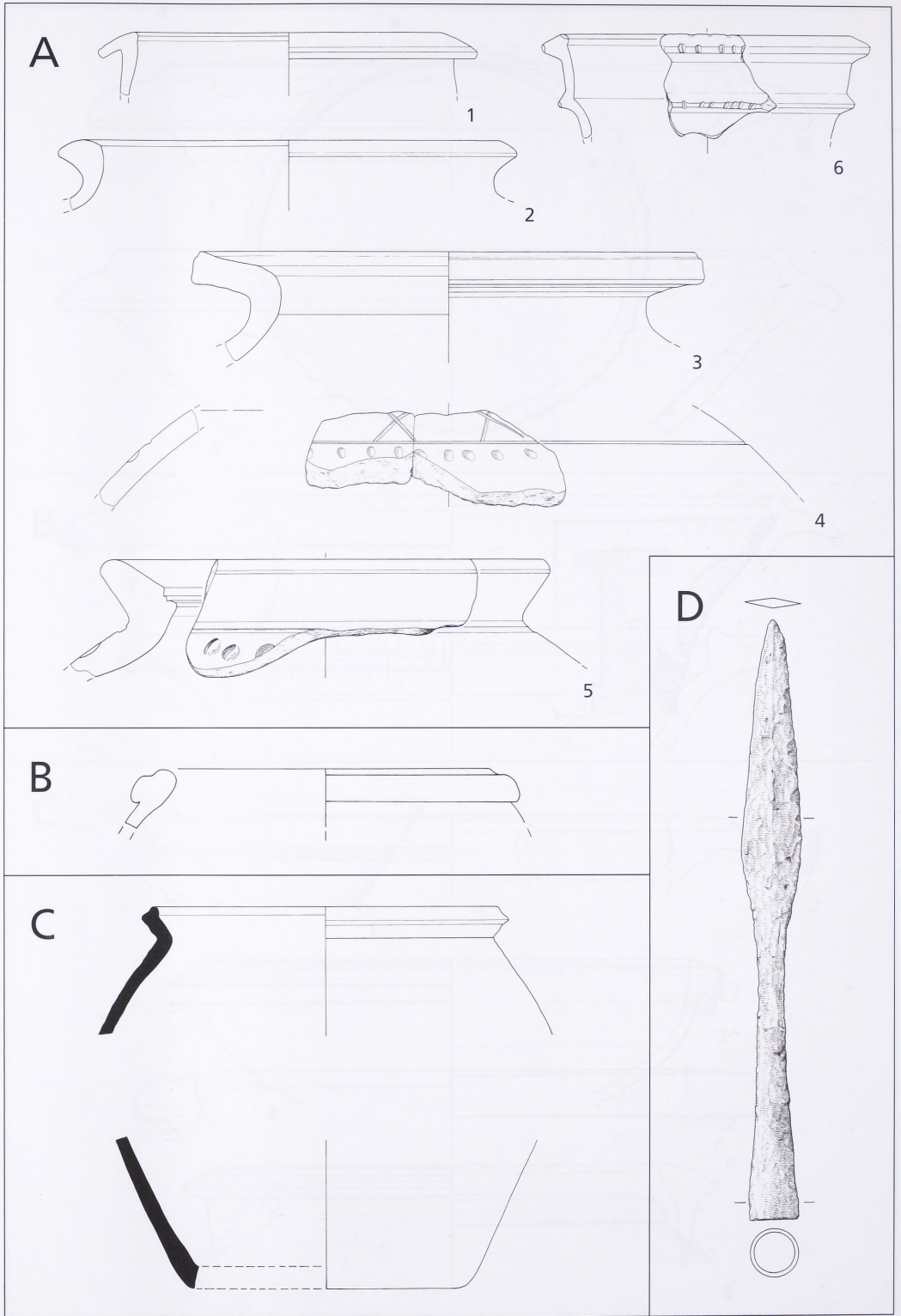

A Reichenbach an der Fils (Lkr. Esslingen). 1-3, 5 u. 6 M 1:3; 4 M 1:4. – B Riegel (Lkr. Emmendingen). Fdst. 2. M 1:3. – C Buggingen (Lkr. Breisgau-Hochschwarzwald). M 1:3. – D Nendingen (Lkr. Tuttlingen). M 1:4.

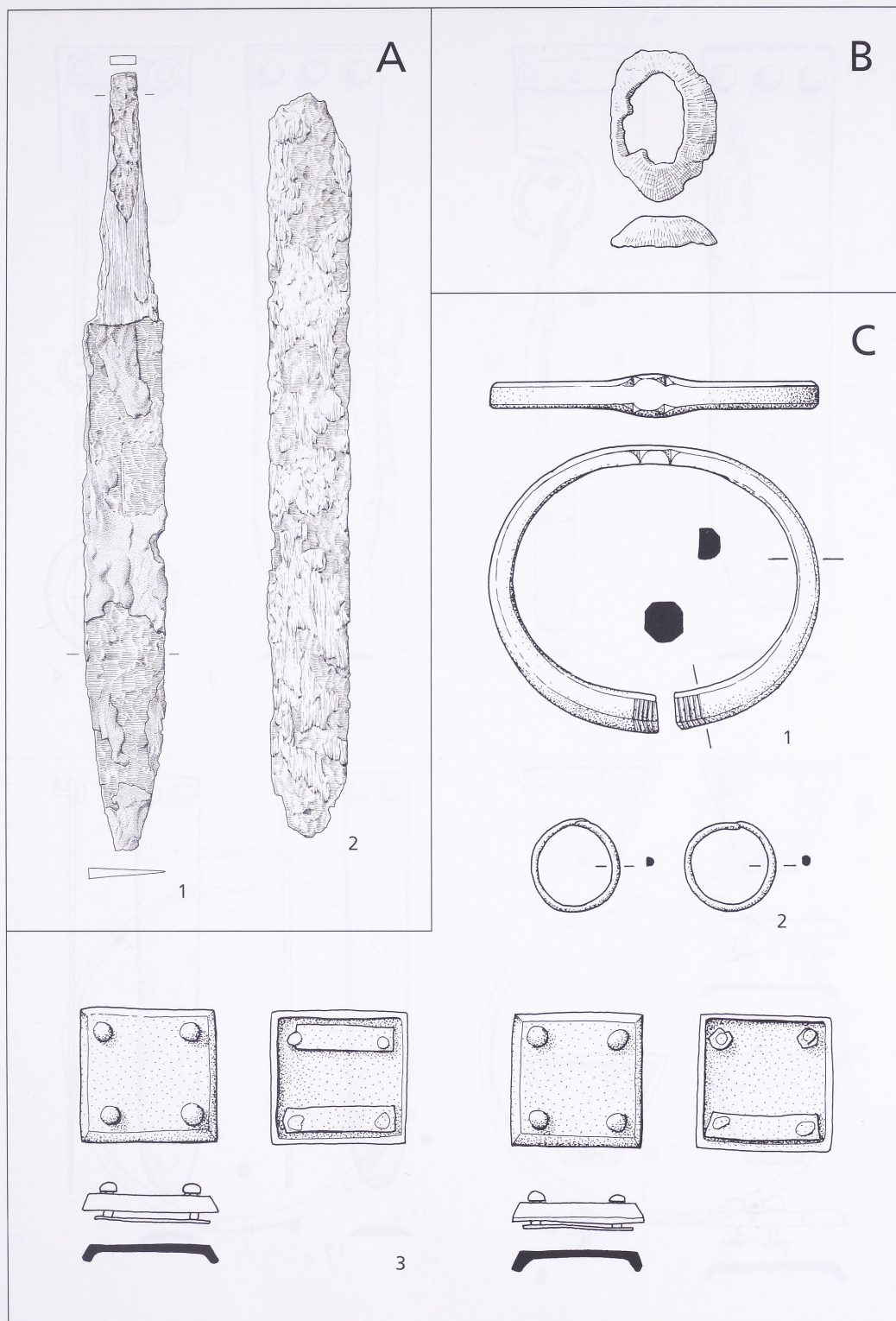

A Nendingen (Lkr. Tuttlingen). M 1:4. – B Offenburg (Ortenaukreis). M 1:3. –
C Sulz am Neckar (Lkr. Rottweil). M 2:3.

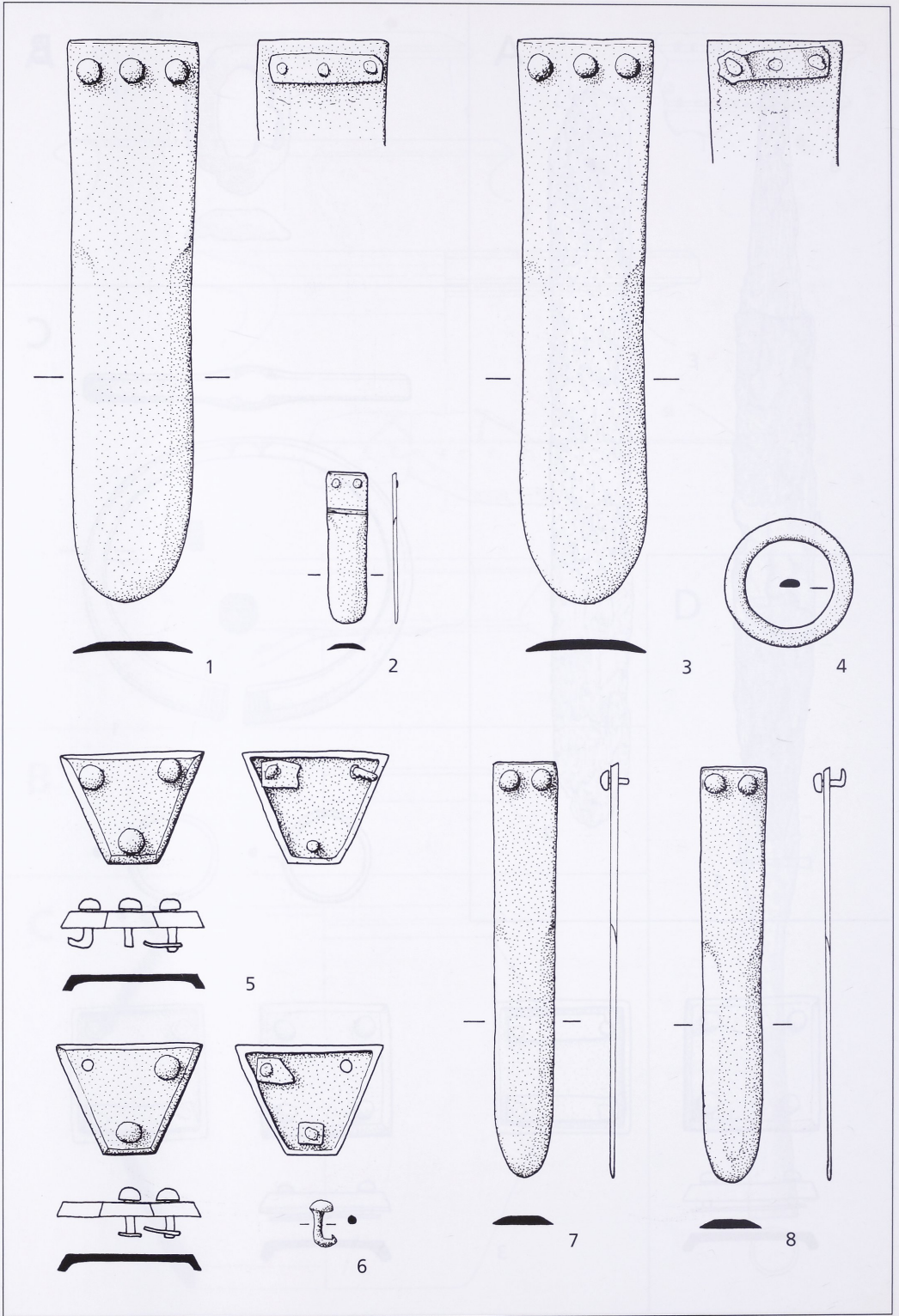

Sulz am Neckar (Lkr. Rottweil). Grab 1. M 2:3.

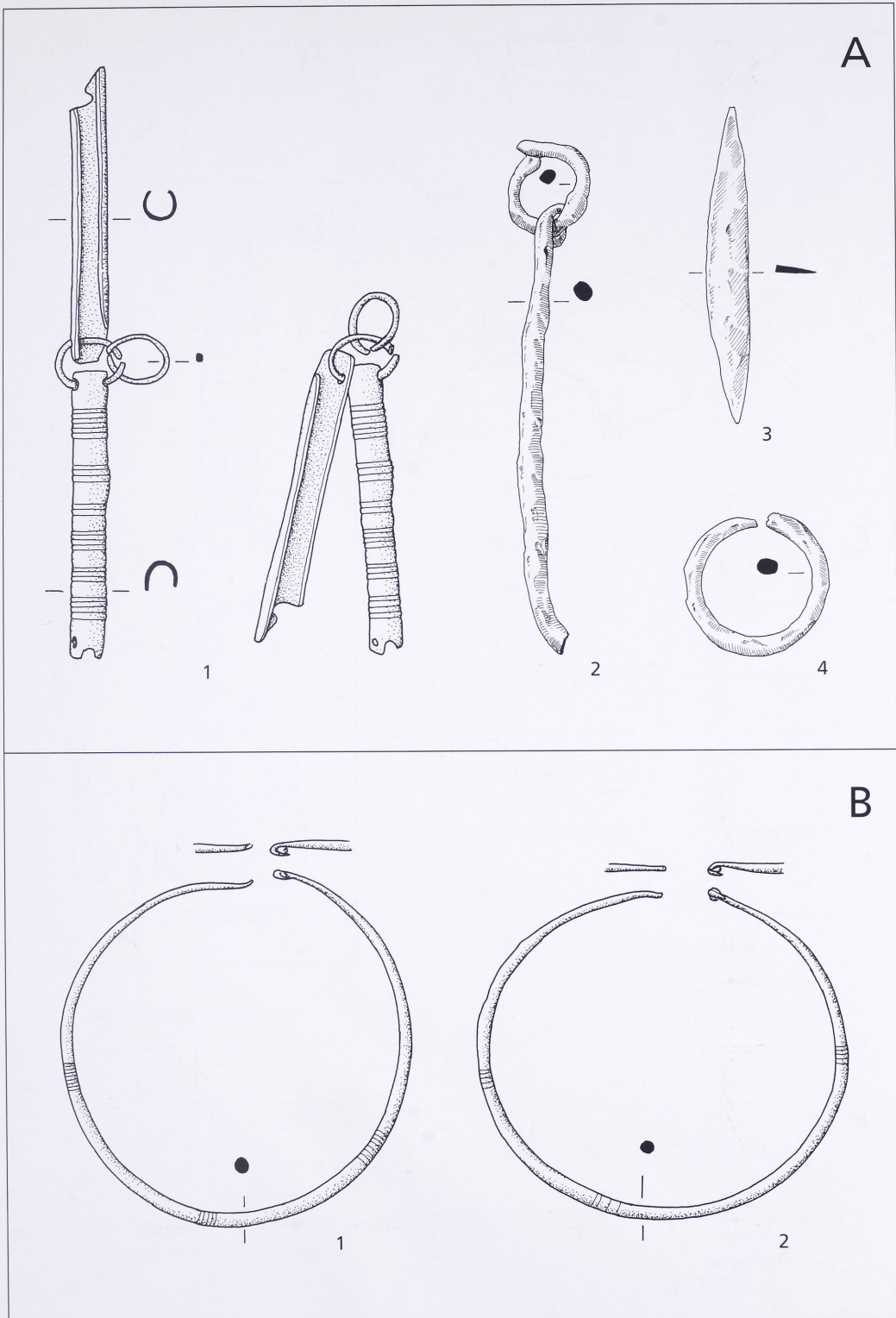

A Sulz am Neckar (Lkr. Rottweil). Grab 1. 1 M 2:3; 2-4 M 1:2. -

B Sulz am Neckar (Lkr. Rottweil). Grab 6. M 2:3.

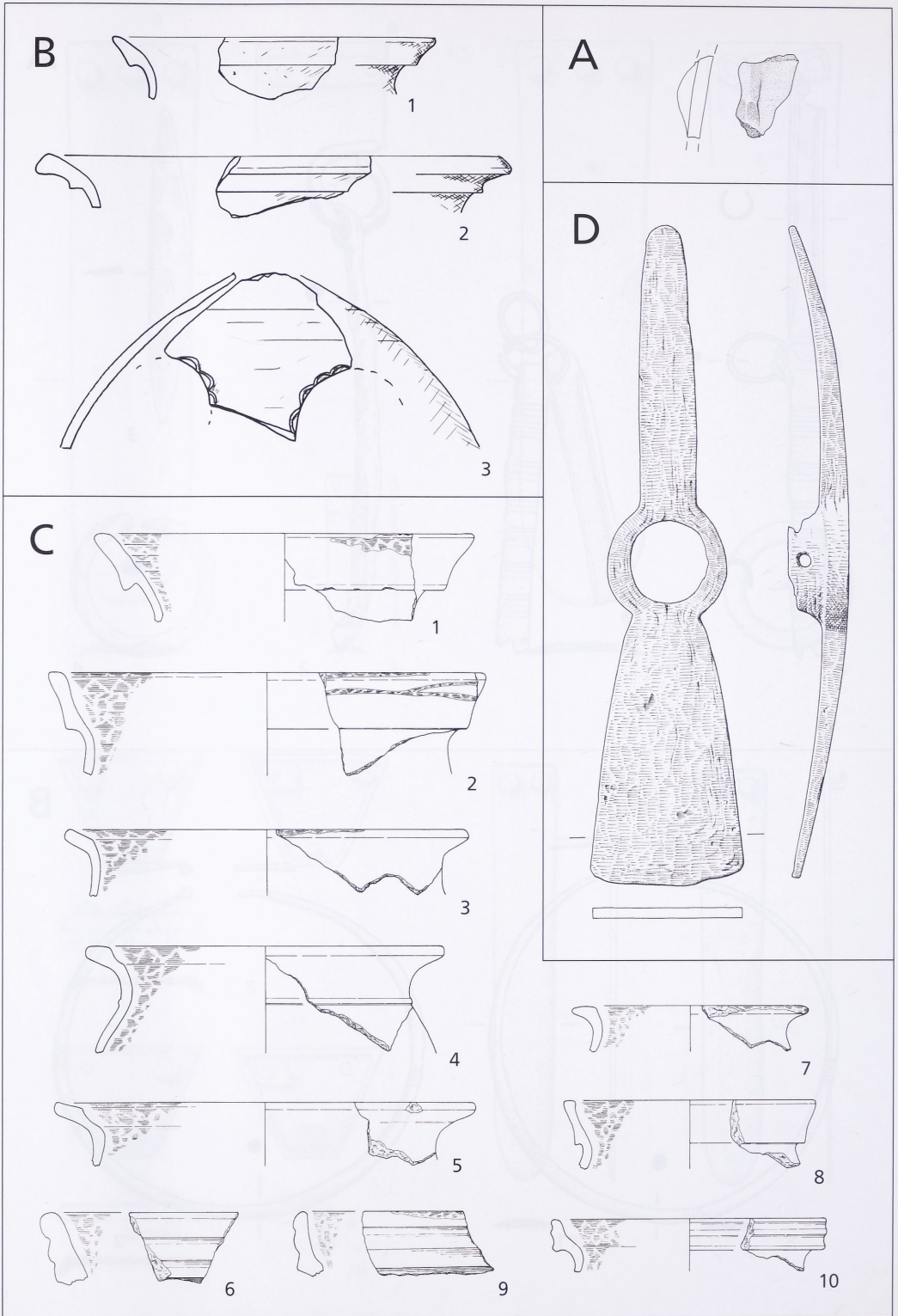

A Balgheim (Lkr. Tuttlingen). M 1:3. – B Engen (Lkr. Konstanz). M 1:3. –
C Freiburg im Breisgau. M 1:3. – D Kehl (Ortenaukreis). M 1:3.

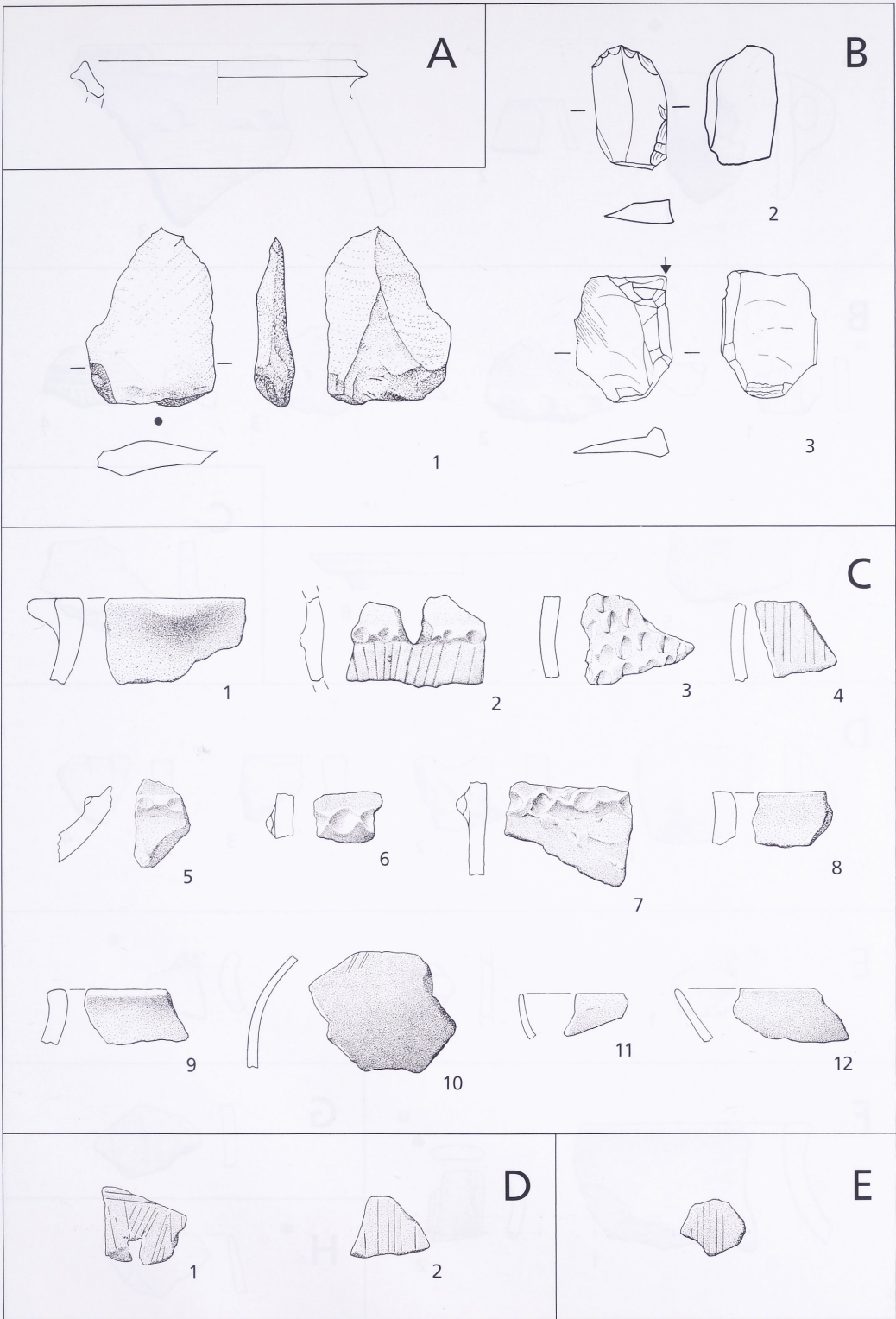

A Forchheim (Lkr. Emmendingen). M 1:3. – B Schwörstadt (Lkr. Lörrach). 1 M 1:2; 2 u. 3 M 2:3. – C Wyhl (Lkr. Emmendingen). Fdst. 2, Bereich I, ohne Fdst.-Angabe. M 1:3. – D Wyhl (Lkr. Emmendingen). Fdst. 2, Bereich I, Fdst. J'. M 1:3. – E Wyhl (Lkr. Emmendingen). Fdst. 2, Bereich I, Fdst. K'. M 1:3.

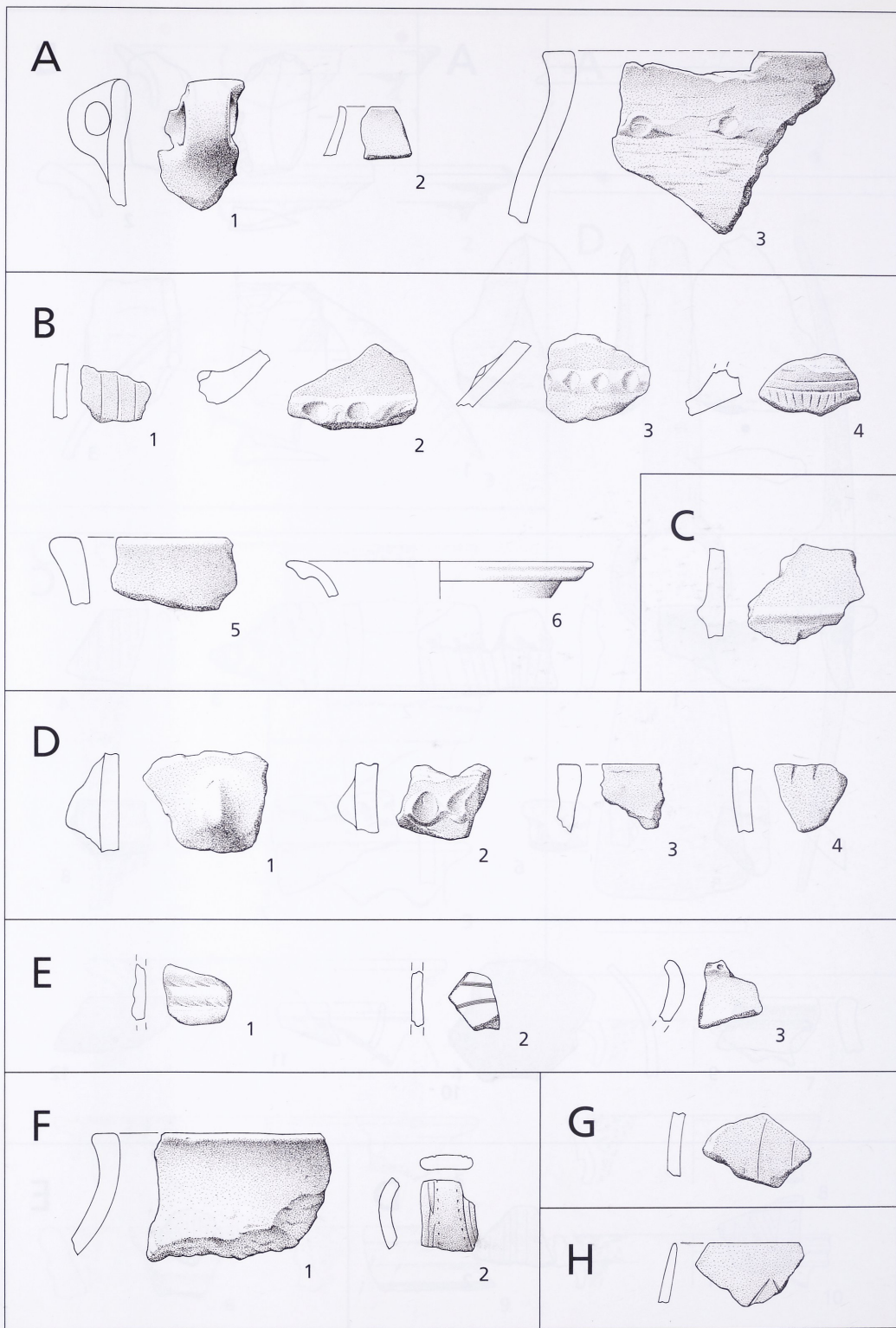

A–H Wyhl (Lkr. Emmendingen), Fdst. 2. M 1:3. A Bereich I, Fdst. ‚L‘. – B Bereich II, ohne Fdst.-Angabe. – C Bereich II, Fdst. ‚A‘. – D Bereich II, Fdst. ‚N‘. – E Bereich III, Fdst. ‚E‘. – F Bereich III, Fdst. ‚F‘. – G Bereich V, Fdst. ‚O‘. – H Bereich V, Fdst. ‚P‘.