

- Martineau, R. and Maigrot, Y. 2004. Les outils en os utilisés pour le façonnage des poteries néolithiques de la station 4 de Chalais (Jura, France). In Bodu, P. and Constantin, C. (eds.) *Approches fonctionnelles en Préhistoire*, 83-95. Actes de XXV^e Congrès Préhistorique de France (Nanterre 24-26 novembre 2000).
- Natali, E. 2014. The earliest pottery in Italy: a technological approach to impressed decoration during the Archaic Phase, *The Old Potter's Almanack* 19(2), 2-13.
- Radi, G. 1991. Il villaggio neolitico di Colle Santo Stefano (Ortucchio). *Il Fucino e le aree limitrofe nell'Antichità*, 110-121. Atti Convegno di Archeologia (Avezzano 10-11 novembre 1989).
- Radi, G., Boschian, G., Calani, L., Pistoia, A. R. and Zamagni, B. 2001. Nuovi dati dal villaggio a ceramica impressa di Colle Santo Stefano (Ortucchio). *Il Fucino e le aree limitrofe nell'Antichità*, 70-81. Atti II Convegno di Archeologia (Celano 26-28 novembre 1999).
- Skakun, N. 1978. Recherche tracéologique expérimentale sur les outils de potiers chalcolithiques. *Sovietskaia Arkheologia* 1, 264-268.
- Shiffer, M. B. and Skibo, J. M. 1989. A Provisional Theory of Ceramic Abrasion. *American Anthropologist*, New Series 91(1), 101-115.
- Skibo, J. M., Butts, T. C. and Shiffer, M. B. 1997. Ceramic Surface Treatment and Abrasion Resistance: An Experimental Study. *Journal of Archaeological Science* 24, 311-317.
- Sullivan, A. P., Skibo, J. M. and Van Buren, M. 1991. Sherds as tools: the roles of vessel fragments in prehistoric succulent plant processing. *North American Archaeologist* 12(3), 243-255.
- Torchy, L. and Gassin, B. 2010. Le travail de la poterie en context chasséen: des outils en silex pour la production céramique? In Maigrot, Y. and Vieugué, J. (eds.) *Outils de potier néolithiques: traditions techniques et organisation des productions céramiques*, 725-735. Actes de la séance de la SPF du 17 mars 2010. Bulletin de la Société Préhistorique Française 107(4).
- Van Gijn, A. and Hofman, C. L. 2008. Were they used as tools? An exploratory functional study of abraded potsherds from two pre-colonial sites on the Island of Guadeloupe, northern Lesser Antilles. *Caribbean Journal of Science* 44(1), 21-35.
- Vieugué, J. 2009. Approche fonctionnelle des tessons a bords abrasés du site neolithique ancien de Kovachevo (6200-5500 avant J. -C., Bulgarie). In Sternke, F., Eigeland, L. and Costa, L. J. (eds.) *Non-Flint Raw Material Use in Prehistory*, 103-109. BAR International Series 1939.
- Vieugué, J., Gomart, L. and Salanova, L. 2010. Les estèques en céramique des potiers néolithiques de l'habitat de Kovachevo (6200-5500 av. J. -C), Bulgarie. In Maigrot, Y. and Vieugué, J. (eds.) *Outils de potier néolithiques: traditions techniques et organisation des productions céramiques*, 709-724. Actes de la Séance de la SPF du 17 mars 2010. Bulletin de la Société Préhistorique Française 107(4).

OLD CERAMICS FIRING KILNS IN SOUTHERN RUSSIAN FAR EAST: FROM PREHISTORY TO THE RECENT PAST

Irina S. Zhushchikhovskaya and Yuri G. Nikitin

Institute of History, Archaeology & Ethnography of the Peoples of the Far East, Far Eastern Branch of Russian Academy of Sciences
 Email: irina1zb@mail.ru; urgen55@yandex.ru

Introduction

The purpose of this article is to present our research on the history of old ceramics firing kilns in the southern part of present day Russian Far East. The research area is the Primor'e region bordering northeast China and the northern part of the Korean peninsula (Figure 1).

The earliest appearances of ceramic technology in the studied territory date to around 13,000-12,000 years ago (Zhushchikhovskaya 2011; Kuzmin 2013). Pottery-making was one of the most important crafts of local populations from the Neolithic to the Early States epoch. In the course of pottery production history, technique and technology developed gradually. As archaeological records show, the earliest kiln-like structures for pottery firing were invented in

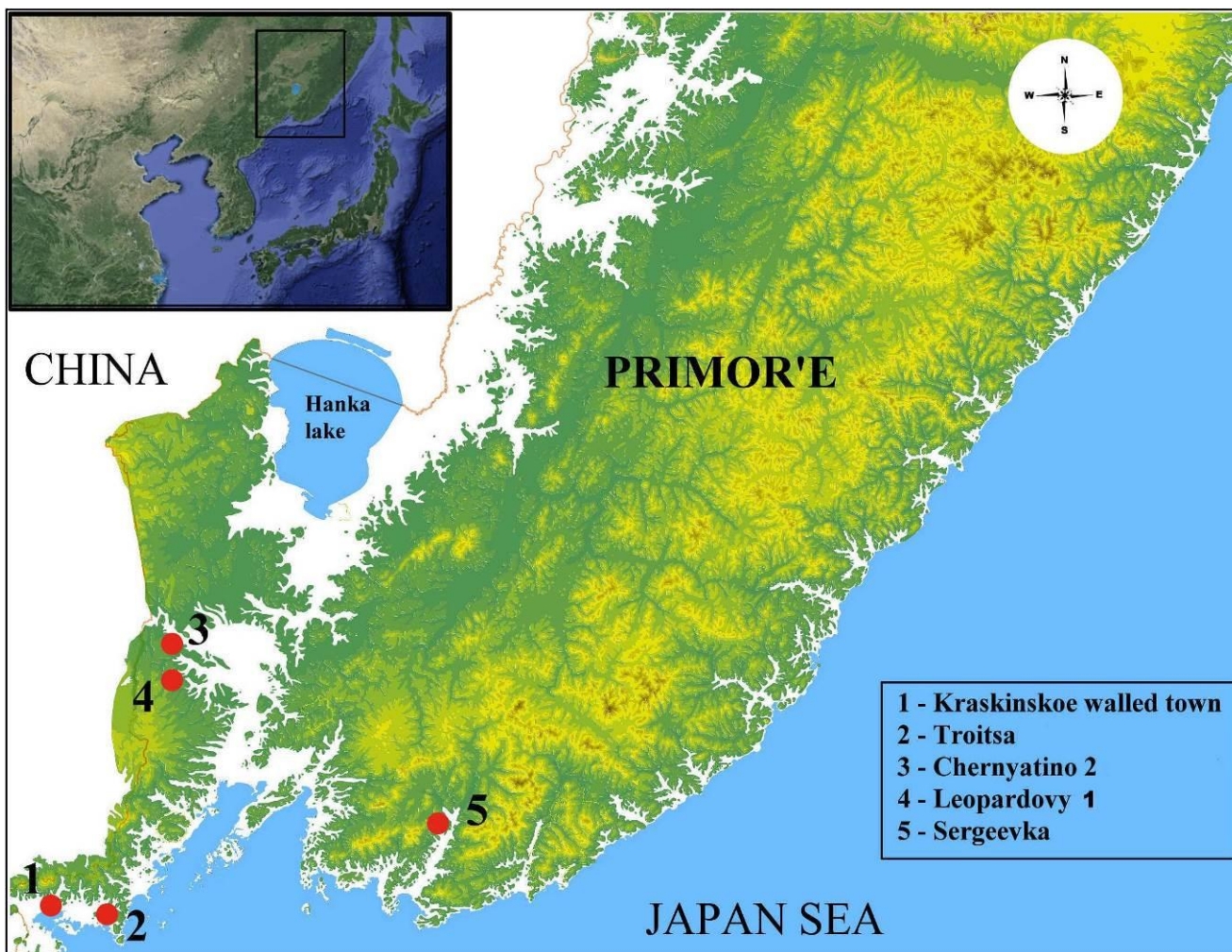

Figure 1. Map of the research area with sites referenced in the article.

the last phase of the Prehistory epoch, in the Paleometal period, between *ca.* 11th/10th c. BC and the 4th/5th c. AD.

At present, remains of ceramic firing kilns have been excavated at the sites of the Paleometal period, Pre-State period and the Early States epoch. Three main types of kiln constructions have been identified in their cultural and temporal contexts. These are described below.

Kiln type 1 is a tunnel-like sloping kiln with deepened floor. This is the oldest and most long-established kiln type in the research area.

The earliest kiln of this type was excavated at the site of Chenyatino-2 (Figure 1: 3) attributed to the Krounovskaya culture of the latest stage of the Paleometal period (Nikitin and Jung 2008; Zhushchikhovskaya and Nikitin 2014a). The site is dated preliminarily to around 4th – 5th c. AD. The remains of the kiln are in a fragmented state and they were located inside the area of the prehistoric settlement, next to the river bank (Figure 2). The

kiln's floor was 0.20 m deep below the soil surface. The oval-shaped kiln floor was 2.30 m long. The floor had traces of burning and was slightly inclined, with a step-like separation between the lower fuel section and the upper firing section. The above-ground part of the kiln was constructed as a kind of dome made of a clay-straw mixture on a wooden framework. Multiple burnt pieces of the dome were scattered over the kiln area (Figure 3: 1-6).

Many pottery fragments were uncovered near the kiln but not inside. Some fragments have visible traces of firing damage such as cracking, deformation and swelling (Figure 3: 6-8). Another sample had a very fragile, crumbling structure indicating a low firing temperature which was not high enough to allow sintering of the clay.

The interpretation concerning the kiln's technical potential is based on some characteristics of pottery unearthed at the site. Surface colours indicate the oxidising regime with the special effect of blackening, or smudging at the final stage of the firing process. Supposedly the firing temperatures were not high

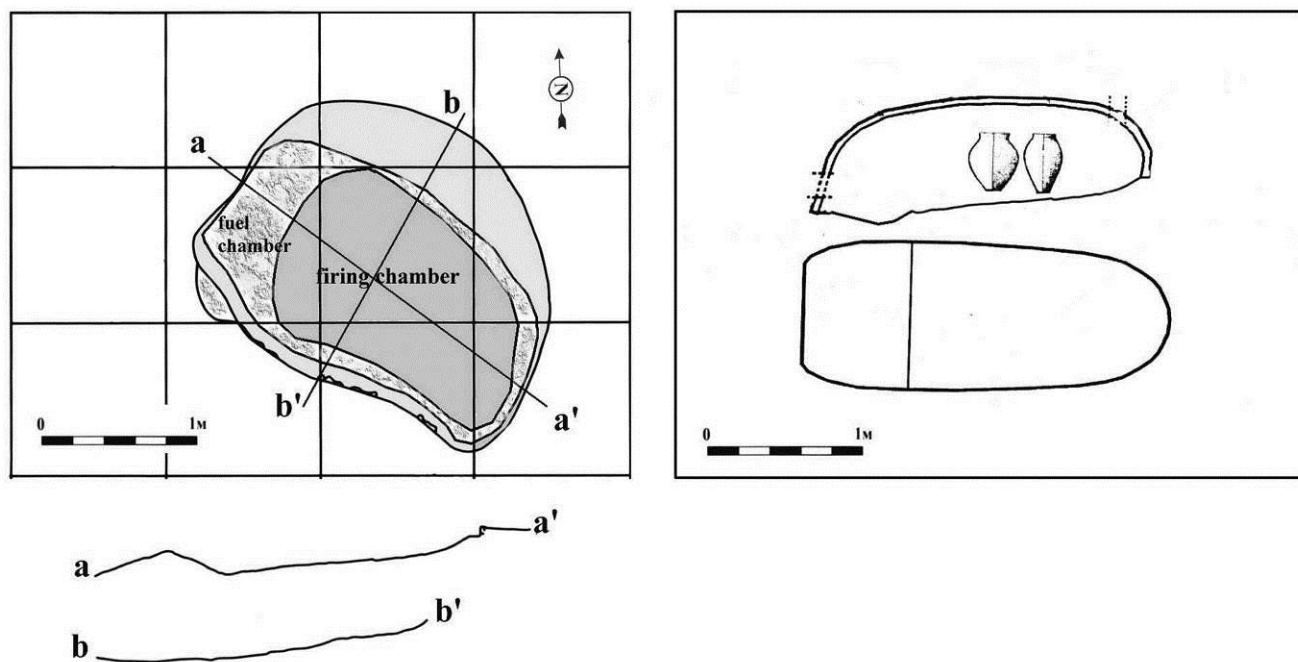

Figure 2. Site of Chernyatino-2, Paleometal period, Krounovskaya culture (tunnel-like kiln remains). Left: horizontal plan at floor level and profile; right: hypothetical reconstruction of the kiln.

but were sufficient for the production of the ceramic body with a relatively low water absorption index (see Rice 1987, 352-353 and Shepard 1985, 127). This index of the Chernyatino-2 pottery varies from 7.4 to 13.2 % with an average value of 10.7%.

The closest analogies of this kiln structure are found in the southern Korean peninsula archaeological record, in particular, at sites dated between the late 3rd and the 4th c. AD. These are the remains of kilns with floors deepened into the soil, lengthened and slightly inclined, with a fuel and a firing section. These earliest Korean kilns are interpreted as descending from the Long kilns of southern China. Firing temperatures for the earliest tunnel-like Korean kilns are thought to have been around 1000 °C (Barnes 1992, 204).

The next temporal stage of tunnel-like sloping kilns in the research area corresponds to the Early States epoch, the period of the Bohai State in the Primor'e region (698-926 AD). The territory of contemporary southern Russian Far East was the eastern part of this state, and the remains of many Bohai walled towns and settlements are known. Ceramic ware made on the potter's wheel and roof tiles are the most numerous artifacts at the Bohai sites of the Primor'e region. The remains of ceramics firing kilns were excavated at some of the sites, and these kilns were attributed to the tunnel-like sloping type.

The most interesting and representative case is a complex of 12 kilns excavated at the walled town of Kraskinskoe located at the margin of the southern part of the research area (Figure 1: 1; Boldin and Nikitin 1999). The site is dated around the 8th and the 9th c. AD. Kiln remains were accumulated in the north-east corner of the ancient town, near the city wall, around the remains of a small temple building. A deep water well was located there. The location and scattering of kiln remains indicate that they were not built and functioned simultaneously, but with some temporal breaks (Boldin and Nikitin 1999).

Kiln floors were deepened into the soil, inclined at 10-15° and in some cases (e.g. kiln N4) covered by a clay layer (Figure 4, Figure 5 *left*). Building materials for kiln walls were stone slabs and clay. The length of kiln tunnels varied between 3.30 and 5.90 m. The kilns' structure was divided into a fuel (furnace) section at the lower part of the tunnel, the firing section comprising most of the tunnel's length, and a flue section at the upper part of the tunnel. In most cases roundish pits, probably intended for the debris and ash, were located at the front of the fuel section. Upper parts of kiln constructions were destroyed and only fragments of domes built of clay and straw mixture were preserved. Some kilns had traces of high temperature burning on the floor and walls.

Not all kilns contained fired ceramics. However, in some cases, roof-tiles and roof-tiles spoilage (wasters)



Figure 3. Site of Chernyatino-2. Paleometal period, Krounovskaya culture: 1-5, fragments of kiln's dome (burnt clay with plant impressions); 6-8, pottery fragments with traces of firing damage.

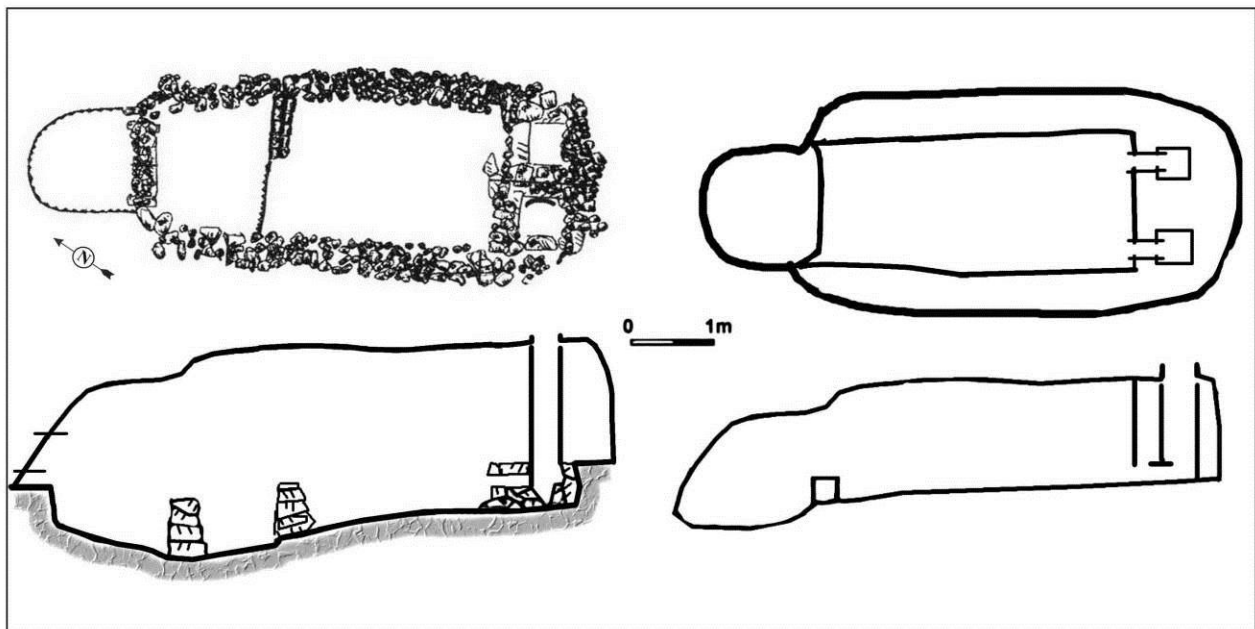

Figure 4. Site of Kraskinskoe walled town (Bobai state period). Remains of the tunnel kiln N4. Horizontal plans and profiles drawn at the end of the excavation.

were found near the kilns (Figure 5 right). Supposedly, the kilns were intended for roof tile firing and served the temple's needs. However, they might also have been exploited for ceramic ware production.

There is no direct evidence of any temperature regime of the kilns. Re-firing testing of a small series of pottery samples from the Kraskinskoe site indicates firing temperatures between 800 and 900 °C. Water absorption index of 41 pottery samples

from the series varies from 8.3 to 16.5%, averaging 13.5%.

Close analogies to tunnel-like sloping kilns of the Bohai sites in the southern Far East are the kilns which were common in the Korean peninsula from the 1st to the 13th centuries AD. Later the more advanced construction of the 'climbing kiln' was invented but simple tunnel kilns were also exploited in the recent past (Osgood 1952, 61, 263-264; Kim and Lee 2006, 70-107; Rha 2006, 111-112).

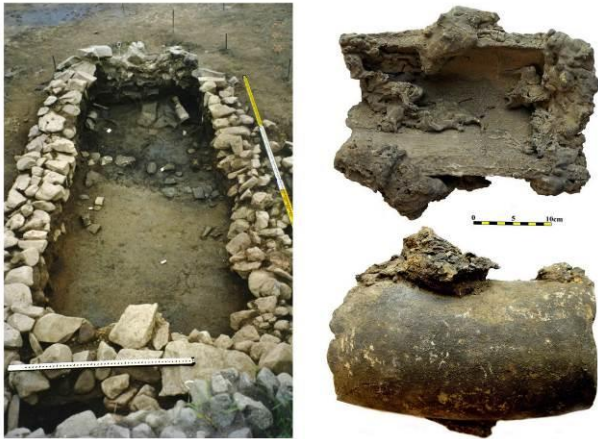

Figure 5. Site of Kraskinskoe walled town (Bobai State period). Left: remains of kiln N4; right: example of fired waster tile.

The remains of tunnel-like structures were excavated in the research area at two sites of the Jin period (1115-1234 AD), when this region was part of the Jin Empire territory. However these cases are not as representative as the tunnel kiln remains of the Bohai State period.

The post-Jin period history of the southern Russian Far East has been poorly studied. Archaeological records are few and isolated, therefore very little can be said about the life of the local population during this period.

The latest appearance of tunnel-like sloping kilns in the research area is dated to the last decades of the 19th c. and first decades of the 20th c. AD, when some groups of Korean village populations migrated to the neighbouring Primor'e region and settled there. At that time this territory was under the government of the Russian Empire (until 1917), and then of the Union of Soviet Socialist Republics (USSR). The Korean migrants brought with them native traditions of material culture and crafts. In particular, ceramic and porcelain wares were imported as part of daily life and as household goods. Some categories of wares - firstly porcelains - were imported from Korea, China and even Japan. However, kitchen ware

was locally produced. Grey-coloured vessels formed on the potter's wheel were fired in simple tunnel-like sloping kilns (Zhushchikhovskaya and Nikitin 2014b).

At present all known Korean settlements dating to 1860 - 1930 are deserted and destroyed. The remains of firing kilns were detected at some of these. One case is the site of Leopardovy-1 (Figure 1: 4) in the western part of the Primor'e region (Zhushchikhovskaya *et al.* 2013). The remains of a firing kiln were discovered at the river bank, not far from the old settlement. The kiln was studied by surface observation and no excavation was carried out. It is 4.50 x 2.20 m oval-shaped and it was dug into the soil and slightly inclined. The above-ground part of the construction is 0.80-0.90 m high. The fuel section formed of roundish river stones is located at the lower end of the kiln tunnel (Figure 6).

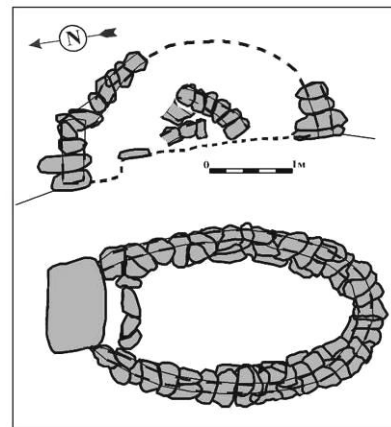

Figure 6. Site of Leopardovy-1: remains of a tunnel kiln used to fire pottery. Top: plan and profile; bottom: the frontal part of the kiln.

The upper part of the firing section was destroyed and collapsed inside. The inner surface of the firing section was coated with a layer of burned clay. Many fragments of grey-coloured thrown pottery were uncovered in the immediate proximity of the kiln.

Some fragments have visible traces of firing deformation due to high temperatures.

The characteristics of pottery fragments from the kiln's area correspond to the earthenware category. Water absorption index varies from 11 to 18%, and surface hardness is 3.0 - 5.0 on the Mohs scale. Grey-coloured thrown pottery discovered at other old Korean sites in the Primor'e region have similar features. It may be supposed that tunnel kilns of the local Koreans did not operate at high temperature.

Kiln type 2 is a two-levelled vertical up-draft kiln discovered at a single site of the Pre-States period. This period, in the research area and neighbouring territories of Northeast China, is represented by numerous sites of Mohe cultural community dated mainly from the 4th to the end of the 7th – beginning of the 8th c. AD. It is important to emphasise the multi-ethnicity and high mobility of the Mohe community which spread over a vast territory of northeast China and the Primor'e region. Some Mohe tribes had close contacts with the Turks of Central Asia. The political structure of the Mohe tribes living in southern Manchuria provided the basis for establishing the first Far Eastern state of Bohai (698-926 AD). In the 8th c. the Mohe peoples of southern Primor'e were incorporated into the Bohai State (Ivliev 2005).

Pottery-making was a common craft at the Mohe settlements. They are known for the appearance of the simplest type of potter's wheel for vessel forming and the evidence of pottery kilns. The remains of two kilns were excavated at the seacoast site of Troitsa at the edge of the southern part of the Primor'e region (Figure 1: 2; Andreeva and Zhushchikhovskaya 1986). The kilns were located near the estuary of a water stream running into the Troitsa bay. The distance between the two kilns was about 3.50 m.

According to the data from our fieldwork, both firing structures can be reconstructed as two-levelled ones of roundish horizontal plan (Figure 7). The lower level of each kiln structure was accompanied by a furnace chamber deepened into the earth to a depth of about 0.80 m and having a fuel loading hole at the side. The bottom diameter of kiln N2 furnace chamber was about 1.50 m, and the furnace chamber of kiln N1 was 1.25 m. The bottoms and walls of both kiln furnace chambers were formed of granitic slabs that had been burned intensively. The upper kiln structure level was the firing chamber with a dome constructed of clay-straw mixture probably on a wooden frame. Multiple burnt pieces of destroyed domes were scattered around the kiln remains. Some traces of a grate-like floor between the furnace and the firing chamber were detected at kiln N2. The

floor was made of clay and small pebbles. Obviously, the direction of the hot air draft inside the kiln was vertical.

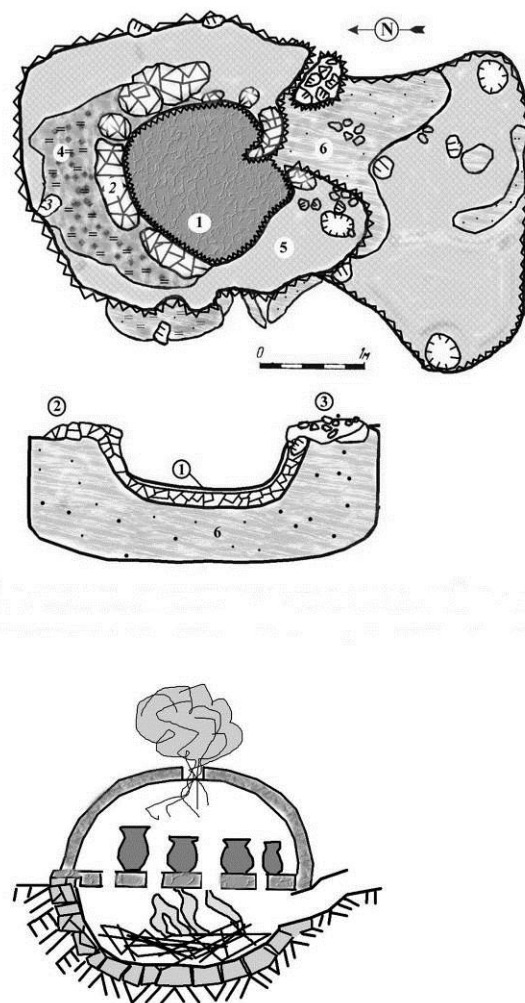

Figure 7. Site of Troitsa, Pre-State period, Mohe cultural community: remains of a vertical up-draft kiln (N2). Top: horizontal plan and profile at the end of the excavation. Bottom: hypothetical reconstruction of the kiln. Legend: 1) chamber bottom (burnt clay); 2) granite slabs; 3) pebbles; 4) accumulation of dome fragments; 5) light-colored raw clay; 6) sandy soil.

About 20,000 pottery fragments were found near the kiln remains, but not inside them. In some cases the evidence of firing damage was clearly visible on the fragments – the cracks and deformations. The thin-section and chemical composition analyses have shown that the pottery was produced from calcareous clay raw material which occurs rarely in the research area. On the basis of the thin-section analysis and re-firing testing, the firing temperature is estimated to be around 800-850 °C (Andreeva and Zhushchikhovskaya 1986).

Analogies of the Troitsa site kilns are not found in the research area. This is a unique case of a two-

levelled, vertical up-draft firing structure in the studied territory. No analogy was found in the archaeological records of the Korean peninsula. In China up-draft two-levelled ceramic kilns were used during the Shang period (Shangraw 1977); later these were replaced by the more advanced and effective *Long* type kilns in southern China, and *Mantou* type kilns in northern China (e.g. Barnes 1992; Kerr and Wood 2004, 314-334; Gerritsen 2012).

The geographically closest region for the use of vertical up-draft round kilns with a furnace chamber dug into the earth, and with a grate separating fuel and firing chambers is Central Asia where these kilns were basic firing structures for ceramic production from the Bronze Age to the medieval period. The vertical kilns of Central Asia shared a common line of development in firing structures with the kilns of the Near East where this type was invented by 6000 BC (Simpson 1977a; 1977b; Saiko 1982). This may suggest that the idea for constructing vertical up-draft kilns was imported by Mohe population from those regions where this type of firing structure was used. We think that the most likely region of origin was Central Asia. Indirect arguments for this scenario may be the traditional high mobility of the Mohe tribes and the close connections of some of them with populations in the Steppe Corridor. Undoubtedly, this idea needs further research.

Kiln type 3 is a compact structure similar to *Mantou* ("steamed bun") kilns characteristic of northern China which appears in the mid-first millennium AD (Kerr and Wood 2004, 314-346). The remains of a complex of several kilns were discovered in the territory of the modern village of Sergeevka (Vasil'ev 1998; 2009). This complex was not far from the Shaiga site of the large Jin period walled town.

The kilns were located at a stream bank close to raw clay deposits suitable for ceramic production. Unfortunately the kilns were intensively damaged by the farming activities of modern villagers. At Sergeevska one kiln numbered N1 was relatively better preserved than the others: this provided the opportunity to determine some features of its construction (Figure 8). Two structural parts are distinguished – the firing chamber and the fuel (furnace) section.

The firing chamber built of adobe bricks was 1.97 m long x 1.62 m wide x 1.5 m high. The long sides of the chamber had slightly convex contours, while the short sides of the chamber, both front and back, were straight. Therefore, the horizontal plan of the firing chamber was similar to an oval with flattened ends.

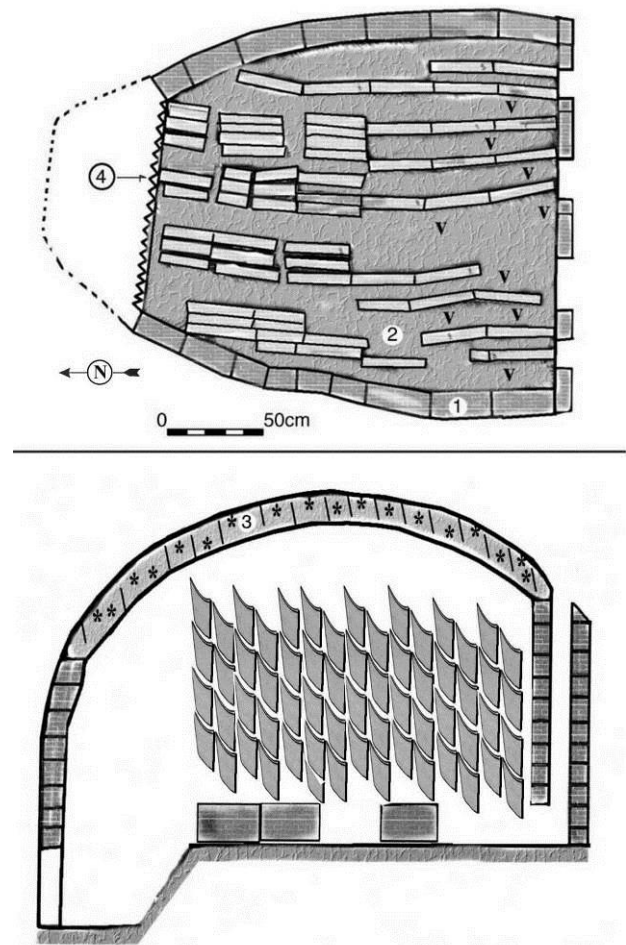

Figure 8. Site of Sergeevka, Jin Empire period. The remains of the *Mantou* type kiln (N1). Top: horizontal plan at floor level (after Vasil'ev 1998: figures 23, 27, 28). Bottom: hypothetical reconstruction of the kiln filled by tiles. Legend: 1) bricks; 2) burnt clay layer on floor; 3) clay dome; 4) line separating the firing chamber from the deeper furnace section; V) traces of ash.

The floor was formed out of flattened, rammed and burnt clay ground surface *c.* 0.05 – 0.07 m thick. On the back wall of the firing chamber at floor level are four flue channels, each 0.08 m wide. Traces of ash were fused on the back part of the floor. Unfortunately, a large part of the back wall and the area beside it were entirely destroyed. Several rows of bricks lying at the ribs paralleling the long axis of the firing chamber were unearthed above the floor. The dome of the firing chamber had collapsed onto the floor; it was constructed of clay mixed with broken tile pieces. Multiple fragments of destroyed dome were unearthed.

The fuel (furnace) section located at the front of the kiln was almost entirely destroyed but it was determined that the bottom of the furnace lay at a lower level than the floor of the firing chamber. Traces of burnt soil were detected in the furnace area.

In general, the features of kiln N1 correspond to the characteristics of *Manthou* kilns which were basic firing structures in northern China during Song and Jin periods. The *Manthou* kiln is also called “horseshoe-shaped” kiln, as its horizontal plan is reminiscent of a horseshoe footprint. The horizontal plan of the Sergeevka kiln is very similar to this pattern. *Manthou* kilns had a single firing chamber with relatively high walls and roof. The hot air entering from the furnace passed up and then down through flue channels in the back wall behind where the chimney was located (Barnes 1992, 202, 203; Kerr and Wood 2004, 314-334; Gerritsen 2012, 168).

The firing chamber of kiln N1 was entirely filled with burned roof tiles (Figure 9). The tiles were deposited densely in four levels, each level consisting of several horizontal rows of tiles oriented in an upright position. The total number of tiles inside the firing chamber exceeded 1,000 units. Morphological traits of the tiles are typical for the roof-tiles excavated at Jin sites in the Primor'e region.



Figure 9. Site of Sergeevka, Jin Empire period: roof-tile sample from kiln N1.

Judging by the colour of the roof tiles, they were fired in oxidising atmosphere and then partially clouded (smudged) by smoke in the firing chamber. The Mohs hardness scale index of the samples is 5.0 – 5.5 and the water absorption index is 13 – 15%. After the re-firing tests, the firing temperature was preliminarily estimated to be around 860-900 °C.

It is important to note that in the Sergeevka kilns area many samples of broken tiles were found, and among them some wasters. Also a small number of very dense, highly-fired tiles were discovered with traditional tiles similar to those from kiln N1. The water absorption index of the highly-fired samples is 2.0 – 2.7%, this is very close to “stoneware” ceramic index. Scanning electron microscopy analysis of these samples' clay pastes shows highly vitrified structures

(Figure 10), with a firing temperature exceeding 1000 °C. It may be supposed that Sergeevka kilns were able to work at different temperature regimes and produce ceramics of different quality.

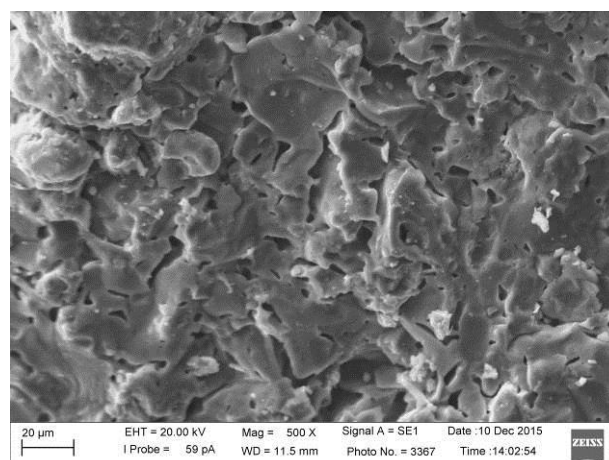

Figure 10. Site of Sergeevka, Jin Empire period: scanning electron microscope image of the fractured ceramic structure of a highly-fired tile.

The appearance of kiln type 3 in the research area seems to be due to the Primor'e region entering into the Jin Empire, 1115 – 1234 AD. The model of the *Manthou* kiln or idea of its construction came from the territory of northern China which was under the Jin government and where the *Manthou* kilns were widely exploited for ceramic production.

Conclusion

Three characteristic types of old ceramic kilns discovered in the Primor'e region have a variety of construction features and cultural-historical patterns (Table 1).

Kiln types 1 and 3 are connected closely with basic models of old Chinese and Korean ceramics firing structures – *Long* kilns and tunnelled kilns, and *Manthou* kilns. Kiln type 2 looks exotic in the research area and may be considered as the result of long-distance cultural contacts across the Steppe Corridor in the 1st millennium AD.

All the described kilns were intended for the firing of ceramic products – pottery and roof tiles. This is indicated by the ceramic wasters found in the kiln areas, and in a single case – the burned ceramic production batch inside the firing chamber.

A separate research task in progress is the determination of the technical potential and technological operating regimes of the described kilns. Preliminary data obtained from the examination of some ceramic samples need to be added. A further interesting perspective may be the

Ancient kiln types of Russian Far East in temporal pattern

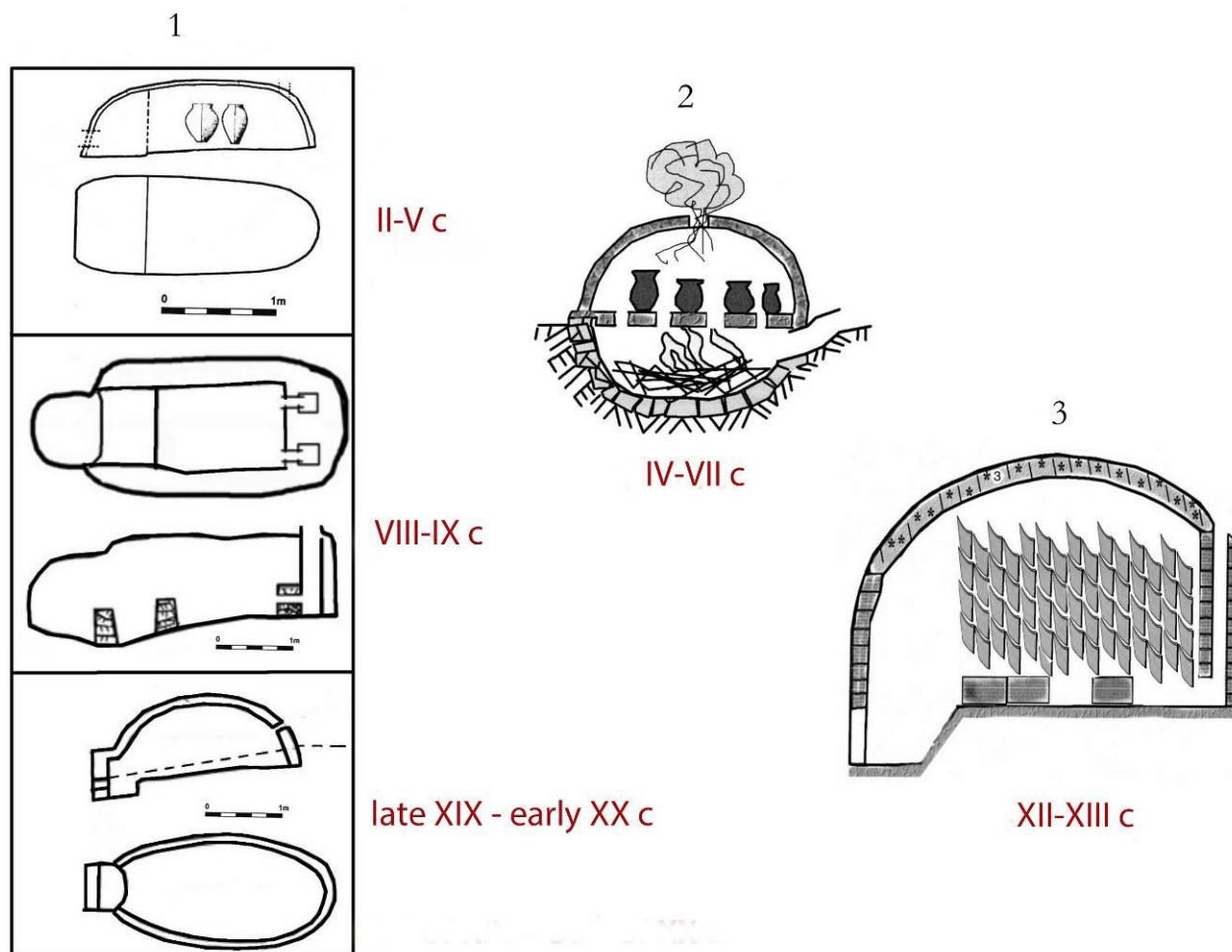

Table 1. Three characteristic types of old ceramic firing kilns discovered in the Primor'e region.

experimental reconstruction of working processes in the different kiln types.

Acknowledgements

SEM analysis was carried out in the Center of Electron Microscopy, Institute of Marine Biology of the Far Eastern Branch of the Russian Academy of Sciences.

References

Andreeva, Zh. V. and Zhushchikhovskaya, I. S. 1986. Goncharye pechi v buhte Troitsa (Ceramics kilns in Troitsa Bay). *Metody estestvennykh nauk v arheologicheskoy izucheni drevnih proizvodstv na Dal'nem Vostoke SSSR*, 68-76. Vladivostok, DVNTs. AN SSSR Press (in Russian).

Barnes, J. L. 1992. The development of stoneware technology in southern Korea. *Pacific Northeast Asia in Prehistory: Hunter-Fisher-Gatherers, Farmers,*

and Sociopolitical Elites, 197-208. Pullman, Washington State University Press.

Boldin, V. I. and Nikitin, Yu. G. 1999. Bohai roof tile from Kraskinskoe ancient town. *The Proceedings of the International Symposium on Ancient Ceramics '99*, 338-346. Shanghai, SICCAS Press.

Gerritsen, A. 2012. Ceramics for local and global markets: Jingdezhen's Agora of Technologies. *Cultures of Knowledge: Technology in Chinese History*, 161-184. Leiden, Brill.

Ivliev, A. L. 2005. Ocherk istorii Bohaya (Essay on the history of the Bohai State). *Rossiysky Dal'ny Vostok v drevnosti I srednevekovie*, 439-448. Vladivostok, Dal'nauka Press.

Kerr, R. and Wood, N. 2004. *Science and Civilization in China*, vol. 5: *Chemistry and technology*, part 12, *Ceramic Technology*. Cambridge, Cambridge University Press.

- Kim, Ch. M. and Lee, B. H. 2006. *Artifacts and Workshops in Baekje*. Buyeo, Buyeo National Museum Press (in Korean).
- Kuzmin, Ya. V. 2013. Origin of Old World pottery as viewed from the early 2010s: When, where and why? *World Archaeology* 45(4), 539-556.
- Nikitin, Yu. G. and Jung, S. B. 2008. *Archaeologicheskie issledovaniya na poselenii Chernyatino-2 v Primorye v 2007 godu* (Archaeological research on the Chernyatino-2 settlement in Primor'e in 2007), vols.1-3. Daejong, Korean State University of Cultural Heritage press (in Russian and Korean).
- Osgood, C. 1952. *The Koreans and Their Culture*. New York, Ronald Press Co.
- Rice, P.M. 1987. *Pottery analysis: a sourcebook*. Chicago, The University of Chicago Press.
- Rha, S. 2006. *Pottery: Korean Traditional Handicrafts*. Seoul, Ewha Womans University Press.
- Saiko, E. V. 1982. *Tekhnika i tekhnologiya keramicheskogo proizvodstva Srednei Azii v istoricheskom razviti* (Technique and Technology of Ceramic Production in Middle Asia in Historical Development). Moscow, Nauka Press (in Russian).
- Shangraw, C. E. 1977. Early Chinese ceramics and kilns. *Archaeology* 30(6), 382-393.
- Shepard, A. O. 1985. *Ceramics for the Archaeologist*. Washington, D.C., Carnegie Institution of Washington.
- Simpson, St. J. 1977a. Prehistoric ceramics in Mesopotamia. *Pottery in the Making: World Ceramic Traditions*, 38-43. London, British Museum Press.
- Simpson, St. J. 1977b. Early urban ceramic industries in Mesopotamia. *Pottery in the Making: World Ceramic Traditions*, 50-55. London, British Museum Press.
- Vasil'ev, Yu. M. 1998. *Raskopki pechei dlya obzhiaga cherepitsy v sele Sergeevka Partizanskogo raiona Primorskogo kraja v 1998 godu* (Field report on the excavation of roof tile firing kilns in the Sergeevka village of Primor'e district in 1998). Unpublished report. Archive Fond 1 (422), Institute of History, Archaeology and Ethnography of Peoples of Far East, Vladivostok (in Russian).
- Vasil'ev, Yu. M. 2009. The furnaces for burning tiles in the village Sergeevka. *The proceedings of the International Symposium on Ancient Ceramics '09*, 840-843. Shanghai, SICCAS press.
- Zhushchikhovskaya, I. S. 2011. The Most Ancient Ceramics: The Course of technological Innovation. *Anthropology & Archaeology of Eurasia* 51(1), 62-78.
- Zhushchikhovskaya, I. S., Nikitin, Yu. G. and Telelyuev, A. 2013. Old Korean Settlements in Russian Primor'e Examined from Archaeological Perspective. *The Journal of Northeast Asian History* 10(2), 165-187.
- Zhushchikhovskaya, I. S. and Nikitin, Yu. G. 2014a. Ceramic Firing Structures in Prehistoric and Ancient Societies of the Russian Far East. *Asian Perspectives* 53(2), 121-149.
- Zhushchikhovskaya, I. and Nikitin, Yu. 2014b. Koreiskie poseleniya kontsa XIX – nachala XX v. Rossiiskom Primor'e: perspektivy arheologicheskogo izucheniya (Korean settlements of the end of the 19th and early 20th centuries in Primor'e District of the Russian Far East: prospects of archaeological investigation). *Archaeological News* 20, 277-286. Saint-Petersburg, Institute of Material Culture History Press (in Russian).

CONFERENCE REVIEW: CPG Annual Meeting November 7th 2015, Durham

Kamal Badreshany

*Durham Archaeomaterials Research Centre
Department of Archaeology
Durham University
Email: kamal.badreshany@durham.ac.uk*

CPG Annual Meeting 2015, Durham

This year's Ceramic Petrology Group annual general meeting took place on November 7th in the Department of Archaeology, Durham University. The meeting, which consisted of eight presentations and drew more than 20 participants, was organised by Kamal Badreshany. As is typical for the CPG annual meeting, the papers covered an interesting and diverse range of methodological, geographical, and chronological topics.